

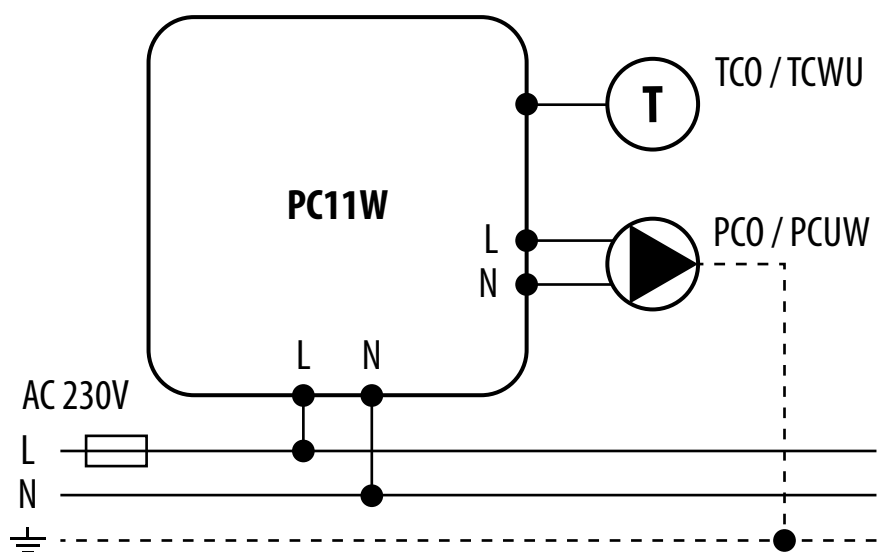















PC11W - Schemat podłączenia.



LEGENDA

| | | | |
|---|--|---|------------------------------|
|  | Zasilanie bateryjne |  | Komunikacja bezprzewodowa |
| L, N | Napięcie zasilania 230V AC |  | Pompa |
|  | Bezpiecznik |  | Siłownik zaworu |
| COM, NO, NC | Styki beznapięciowe wyjściowe |  | Czujnik temperatury |
| S, S1, S2 | Oznaczenie wejścia |  | Wentylator 3-biegowy 230V AC |
| SL | Wyjście napięciowe 230V AC |  | Żarówka lub inne obciążenie |
|  | Styk normalnie otwarty (zwierany) |  | Siłownik termoelektryczny |
|  | Styk normalnie zamknięty (rozwierany) |  | Programator czasowy |
|  | Styk przełączny NC/COM/NO |  | Zewnętrzny styk zwierany |
|  | Kocioł - Podłączenie kotła* - Styki w kotle do podłączenia regulatora ON/OFF (wg instrukcji kotła) |  | Transformator |