

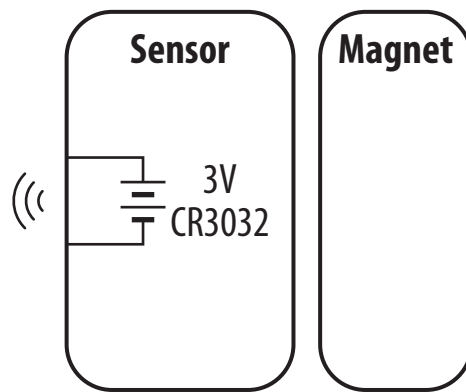





OS600

WIRING DIAGRAM



LEGEND

| | | | |
|---|--|---|---------------------------------|
|  | Battery powered |  | Wireless communication |
| L, N | 230V AC power supply |  | Pump |
|  | Fuse |  | Valve actuator |
| COM, NO, NC | Voltage-free output |  | Temperature sensor |
| S, S1, S2 | Input terminals |  | 3-speed 230V AC fan |
| SL | 230V AC voltage output |  | Light bulb or other load |
|  | Contact normally open NO |  | Thermoelectric actuator |
|  | Contact normally closed NC |  | Time programmer |
|  | NC/COM/NO switch |  | External normally open contact |
|  | Boiler - Boiler connection* - Boiler's contacts for ON/OFF thermostat (according to the boiler's instructions) |  | Transformer (voltage converter) |