

SALUS

EP PUMPER



5 ÅRS
GARANTI



Nem
Installation



Høj
Komfort



Lavt
Energiforbrug

OM PRODUKTERNE

Salus EP elektroniske A-klasse cirkulationspumper er velegnet til alle typer varmeanlæg. Pumpen har flere indstillinger.

Vælg bl.a. mellem automatisk tryk, og flow justering, eller en af flere konstant tryk indstillinger.

Det minimale energiforbrug kan nå ned til 5W.

EP15-40-130 - VVS NR: 381002140

EP15-60-130 - VVS NR: 381002160

SALUS
CONTROLS
www.saluscontrols.com/dk



5 ÅRS
GARANTI



DATABLAD

EP15-40-130 - VVS NR: 381002140

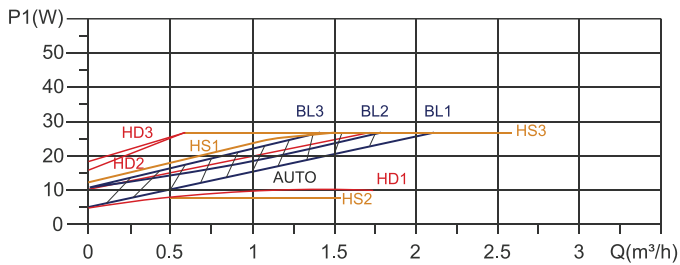
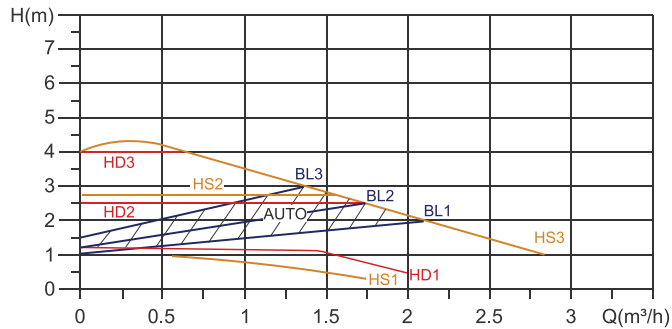

EP15-60-130 - VVS NR: 381002160

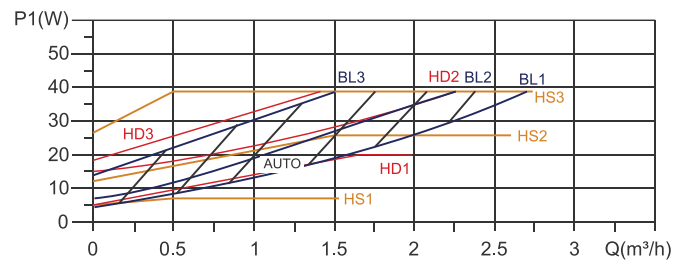
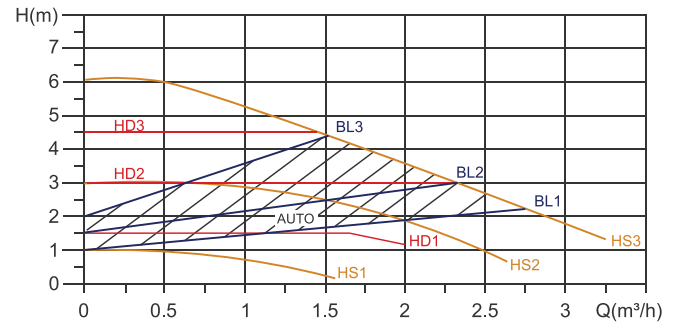

Forsyningsspænding	220-240 V AC 50/60Hz	
Motorbeskyttelse	Pumpen har ikke brug for ekstern beskyttelse	
Beskyttelsesklasse	IP44	
Isoleringsklasse	H	
Luftens relative luftfugtighed i miljøet (RH)	Maks. 95%	
Systemets trykbærende egenskaber	Max 1.0 MPa, 10 bar	
Indgangstryk for sugning	Væsketemperatur	Minimum indgangstryk
	≤+75 °C	0.005 MPa
	≤+90 °C	0.028 MPa
	≤+110 °C	0.100 Mpa
EMC-standarder	EN61000-6-1 og EN61000-6-3	
Lydtryksniveau	Vandpumpens lydtryksniveau er under 42 dB (A).	
Omgivelsestemperatur	0 ~ +70 °C	
Temperaturklasse	TF110	
Overfladetemperatur	Den maksimale overfladetemperatur bør ikke overstige + 125 °C	
Væsketemperatur	2~ +110 °C	
Glycol	≤ 30%	

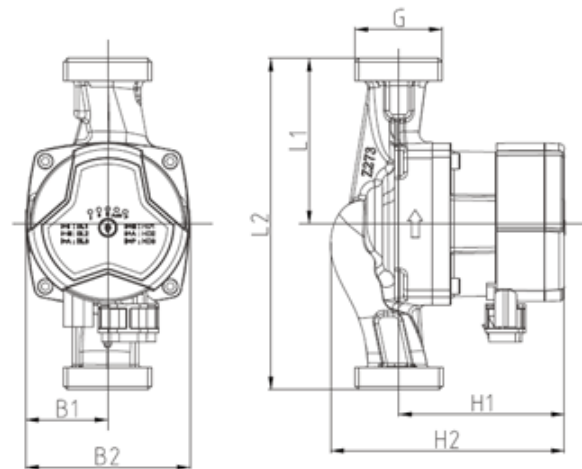

Type	B1	B2	L1	L2	H1	H2	G
EP15-xx-130	45	90	65	130	90	128	1"

