



WQ610 THERMOSTAT - FULL USER MANUAL

SALUS
CONTROLS

TABLE OF CONTENTS

1. Introduction	4
1.1 Product Compliance	4
1.2 Safety Informations.....	4
2. Product Overview	5
2.1 Example of boilers compatible with the OpenTherm OT+ 4.0 protocol.....	6
2.2 Package content	7
2.3 Proper thermostat location	7
2.4 Connection description.....	8
I A - Boiler connection	8
I B - Pump / Valve connection	8
3. Before you start (first power up)	9
3.1 LCD icon description	9
3.2 Button description.....	9
3.3 First power up sequence and configuration	10
4. Operating	11
4.1 Setpoint temperature change (manual mode)	11
4.2 Schedule mode - programming schedule.....	12
4.3 Temporary override mode	13
4.4 OFF mode	13
4.5 Language	14
4.6 Advanced settings	15
4.6.1 DST (Daylight Saving Time) setting	15
4.6.2 Display temperature accuracy	16
4.6.3 PIN Code.....	16
4.6.4 Service alert	17
4.6.5 Optimum Start	18
4.6.6 Optimum Stop	18
4.6.7 Thermostat temperature calibration	19
4.6.8 Minimum setpoint temperature.....	19
4.6.9 Maximum setpoint temperature	19
4.6.10 Frost protection temperature	20
4.6.11 Control algorithm.....	20
4.7 Holiday mode	21
4.8 Time/Date	22
4.9 BOOST hours - hourly temperature override	23
4.10 Operating mode	24
5. Factory Reset	25
6. Error codes	26
7. Cleaning and Maintenance	27
8. Technical Informations	27
9. Warranty	28

1. Introduction

1.1 Product Compliance

This product complies with the essential requirements and other relevant provisions of Directives 2014/53/EU and 2011/65/EU. The full text of the EU Declaration of Conformity is available at the following internet address: www.saluslegal.com.

1.2 Safety Informations

- Before starting installation work and before using the product, read the entire manual.
- The information contained in the instructions is essential for proper functioning.
- To avoid accidents resulting in personal injury and material damage, please follow all safety precautions, specified in this manual.
- The device should not be used by people with limited mental, sensory or mental abilities, without experience, of insufficient knowledge as well as children.
- Do not use an unassembled device (eg without a cover).
- The device may only be opened by a qualified person.
- Keep electrical devices out of the reach of children and ensure that they do not play with it. Children should not be left unattended. If necessary, disconnect the control system for the entire room.
- Do not leave the packaging, cabinet, or any loose parts of the device unattended, as they pose a risk to children.

WARNING!

- Installation must be carried out by a qualified person with appropriate electrical qualifications in accordance with standards and regulations in force in the given country and in the EU.
- Never try to connect the device other than as described in the manual.
- Before assembly, repair or maintenance as well as during any connection works it is absolutely necessary disconnect the mains supply and make sure that the terminals and electric wires are not live.
- The device may not be exposed to extreme temperatures, strong vibrations or subjected to mechanical shock.
- The device should not be used in unfavorable environmental conditions or in rooms where there is a concentration of flammable gases, fumes or dust.

WARNING!

- There may be additional protection requirements for the entire installation that the installer is responsible for maintaining.



Care for the natural environment is of paramount importance to us. The awareness that we manufacture electronic devices obliges us to dispose of used electronic components and devices safely. Therefore the company has received a registration number issued by the Chief Inspector for Environmental Protection. The crossed out symbol the trash can on the product means that the product must not be disposed of with ordinary waste containers. Sorting waste for recycling helps to protect the environment. It is the user's responsibility to surrender used equipment to a designated collection point for recycling waste from electrical and electronic equipment.

2. Product Overview

The WQ610 room thermostat simply switches the heating system on and off as necessary. It works by sensing the air temperature, switching on the heating when the air temperature falls below the thermostat setting, and switching it off once this set temperature has been reached.

Turning a room thermostat to a higher setting will not make the room heat up any faster. How quickly the room heats up depends on the design of the heating system, for example, the size of boiler and radiators. Neither does the setting affect how quickly the room cools down. Turning a room thermostat to a lower setting will result in the room being controlled at a lower temperature, and saves energy.

The heating system will not work if a time switch or programmer has switched it off.

The way to set and use your room thermostat is to find the lowest temperature setting that you are comfortable with, and then leave it alone to do its job. The best way to do this is to set the room thermostat to a low temperature – say 18°C – and then turn it up by one degree each day until you are comfortable with the temperature.

You won't have to adjust the thermostat further. Any adjustment above this setting will waste energy and cost you more money.

If your heating system is a boiler with radiators, there will usually be only one room thermostat to control the whole house. But you can have different temperatures in individual rooms by installing thermostatic radiator valves (TRVs) on individual radiators. If you don't have TRVs, you should choose a temperature that is reasonable for the whole house. If you do have TRVs, you can choose a slightly higher setting to make sure that even the coldest room is comfortable, then prevent any overheating in other rooms by adjusting the TRVs.

Room thermostats need a free flow of air to sense the temperature, so they must not be covered by curtains or blocked by furniture. Nearby electric fires, televisions, wall or table lamps may prevent the thermostat from working properly.

Thermostat is compatible with OpenTherm OT+ 4.0 version.

The OpenTherm protocol is an open standard communication protocol used in central heating systems for two-way communication between a central heating boiler and a room thermostat. Thanks to the communication protocol, the boiler power is modulated, which can significantly increase the energy efficiency of the heating system while maintaining the set temperature in the room. OpenTherm modulation, compared to standard communication (ON / OFF), occurs by setting the desired temperature of water from the boiler (boiler power), and not by its cyclical switching on and off.



PLEASE NOTE!

Make sure your gas combi boiler is compatible with OT + 4.0 communication protocol.
The list of compatible boilers is on the next page.

Product advantages:

- automatically detects the OT+ 4.0 protocol and regulates the DHW temperature
- possibility to choose hysteresis or built-in ITLC algorithm
- working according to time schedules
- PIN-protected service mode
- maximum/minimum temperature limit
- may temporarily change the temperature (overwriting until the next program change)

2.1 Example of boilers compatible with the OpenTherm OT+ 4.0 protocol

COMPANY	MODEL	COMPANY	MODEL
Alpha Heating	E-Tec S E-tec Plus E-tec Evoke Intec GS	Vokera	Linea HE Mynute A Mynute HE Unica HE
Atag	iC iC Economiser iS	Viessmann	Vitodens 100W Typ WB1A (Connection: X3.3 and X3.4) Vitodens 100W Typ WB1B (Connection: X21.1 and X21.2) Vitodens 100W Typ WB1C (Connection: X21.1 and X21.2) Vitodens 200-W WB2B 26+ 35 kW (via Expansion Module OT and OT-A8 + _Terminal -10 and +10 are on the extension of the A8 boiler) Vitodens 200-W WB2C, B2HA,B2JA, B2LA (via icm Expander OpenTherm)
Baxi	100 Combi 200 Combi 400 Combi 600 Combi	Vaillant (via Vaillant VR33 module)	Ecotec Pro Ecotec Plus Ecotec Exclusive Ecofit Pure
Daikin	D2CND 24Kw D2CND 28kw D2CND 35kw	Worcester Bosch (via Nefit EMS-OT OpenTherm converter)	EMS capable boilers Greenstar i Greenstar i Junior (Made in July 2013) Greenstar Si Compact Greenstar CDi Compact Greenstar CDi Classic (Made after 16.01.2007 with CF12.10 software version and newer) Greenstar Highflow CDi Greenstar 12i System – 24i System (On condition that an optional integrated diverter valve manufactured after February 2011 is installed) Greenstar 27i System – 30i System (Provided the optional Integrated Changeover Valve is installed Greenstar CDi Classic System (provided the optional Integrated Changeover Valve manufactured after 02/16/2007 with software version CF12.10 and above is installed))
Ferrol	i25 Condensing Combination Boiler i29 Condensing Combination Boiler		
Ideal	Independent + Combi Independent Combi Independent System Logic Combi+ Combi C Logic Combi C24, C30, C35 (via a separate bundle set) Logic Code Combi (via a separate bundle set) I-mini C24, c30 (via a separate bundle set) Vogue Combi C26,C32, C40 Logic + System Logic + Heat		
Intergas	Intergas Rapid Intergas Rapid Plus Combi Compact, Compact Range ECO RF Xtreme Xclusive		
Main	Eco Compact Combi 25-30		
Navien	Navien NCB		
Ravenheat	Avanta, Quinta Ace Quinta Pro Gas 110 Eco		
Vokera	Evolve C Evolve S Linea One (przez OpenTherm Kit Part_1221179) Vision Combi (requires a control interface 294501430) Compact A (requires a control interface 29450143) Verve (only heating mode) Mynute I (only heating mode) Vision System (only heating mode) Unica I Vibe Vision C		

2.2 Package content

- 1) WQ610
- 2) Short instruction
- 3) Mounting screws



2.3 Proper thermostat location

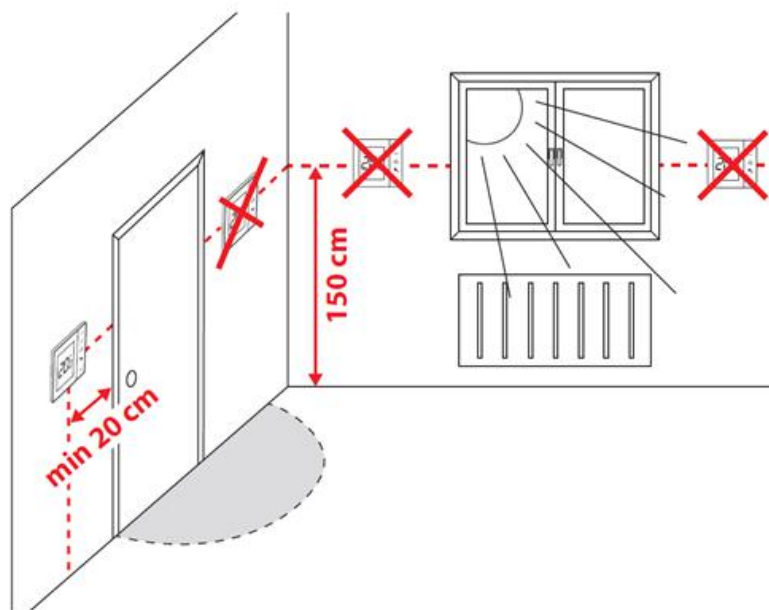

Please note:

The ideal position to thermostat mounting is about 1,5m under floor level far from heating or cooling sources. Thermostat can't be exposed to sunlight or any extreme conditions like for example draft.

Because of fire and explosion risk there is not allowed to use thermostat in atmosphere of explosive gases and flammable liquids (eg coal dust). In case if any of listed dangers occur you have to use additional protection measures – anti-dust and explosive gases (tight cover) or prevent their formation. Furthermore, thermostat can't be used in condensation of water vapor conditions and be exposed to water action.

2.4 Connection description

I A - Boiler connection

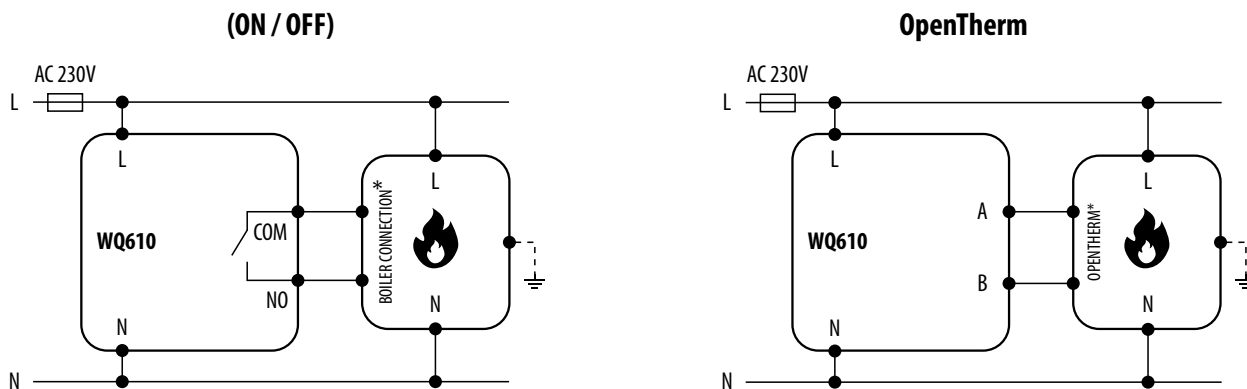

i DO NOT connect to OpenTherm terminals unless your boiler is OpenTherm Association approved and has the OpenTherm Logo.

I B - Pump / Valve connection

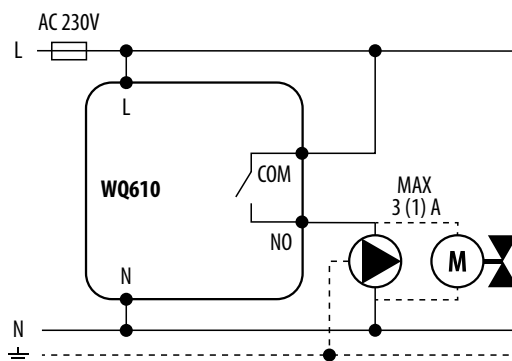

Legend:



Boiler - Boiler connection*
- Boiler's contacts for ON/OFF thermostat (according to the boiler's instructions)



Pump



Valve

Symbols explanation:

L, N - power supply 230V

NO, COM - voltage-free output

A, B - OpenTherm Communication Wire

- fuse

3. Before you start (first power up)

3.1 LCD icon description

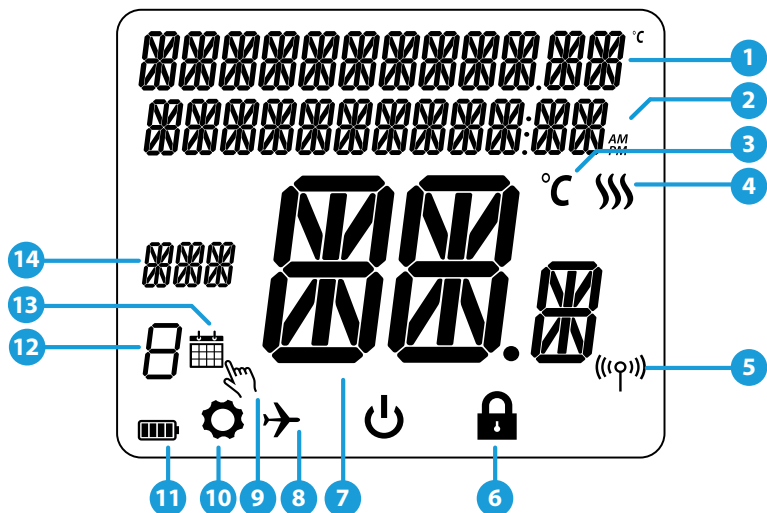

- | | |
|---|------------------------------------|
| 1. Menu/Settings description | 8. Holiday mode indicator |
| 2. Clock 24hr/AM/PM | 9. Temporary override mode |
| 3. Temperature unit | 10. Settings icon |
| 4. Heating indicator (icon is animating when there is heating demand) | 11. Battery indicator |
| 5. RF Connection indicator (WQ610RF only) | 12. Schedule program number |
| 6. Advanced settings lock indication | 13. Schedule mode icon |
| 7. Current /Setpoint Temperature | 14. Day indicator/ SET information |

3.2 Button description



- | | |
|---|--|
| 1. MENU - enter the menu options, press and hold for 3 seconds to return to main screen without saving changes. | 3. UP - increase the temperature and move through the menus. |
| 2. DOWN - decrease the temperature and move through the menus. | 4. TICK - confirm changes and enter menus. Press and hold for 3 seconds to exit User Menu and save changes. Press and hold to cancel BOOST feature or temporary override (while in main screen). |

 **PLEASE NOTE!** The LCD screen can be activated by using any button.

3.3 First power up sequence and configuration

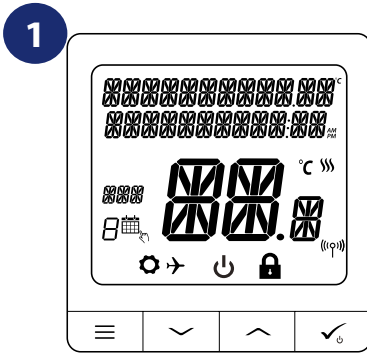

After connecting to 230V power supply, the thermostat will power up.

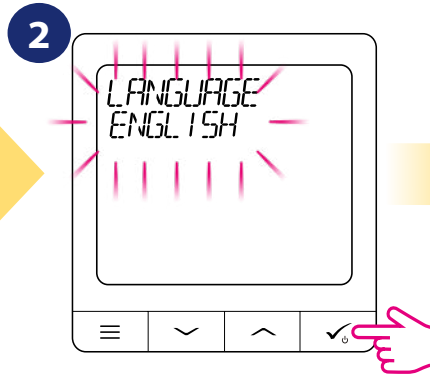

Using \downarrow or \uparrow , choose your language and then press \checkmark .



Using \downarrow or \uparrow , choose the time format and then press \checkmark .

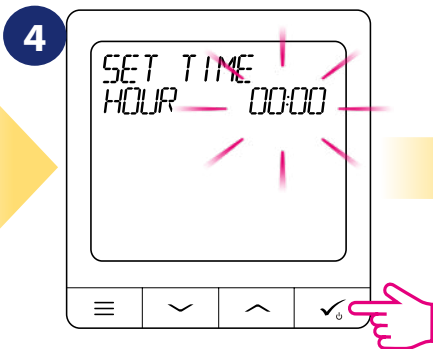

Using \downarrow or \uparrow , set the hour and then press \checkmark .

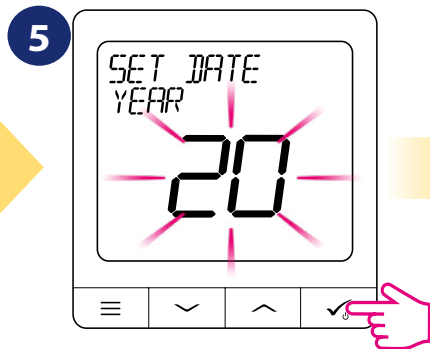

Using \downarrow or \uparrow , set the year and then press \checkmark .

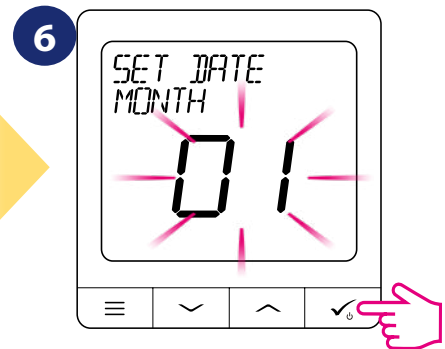

Using \downarrow or \uparrow , set the month and then press \checkmark .

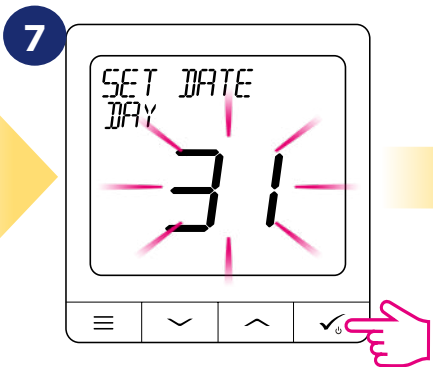

Using \downarrow or \uparrow , set the day and then press \checkmark .

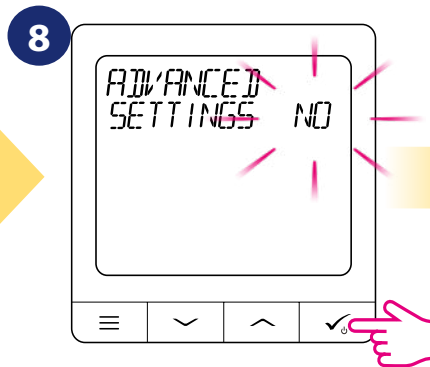

Using \downarrow or \uparrow , choose if you want to set advanced settings (you can always edit them later) then press \checkmark .

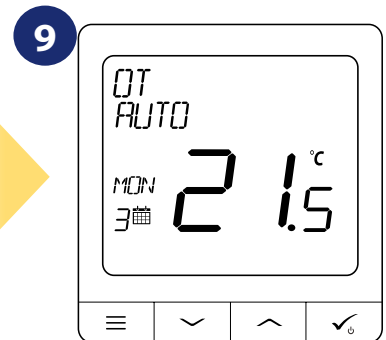



Thermostat is displaying main screen.

4. Operating

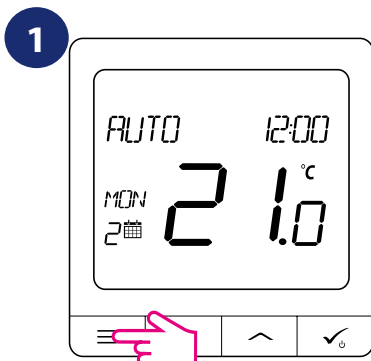

4.1 Setpoint temperature change (manual mode)

In manual mode, the thermostat maintains a constant temperature set by the user. A hand icon is displayed when manual mode is active.



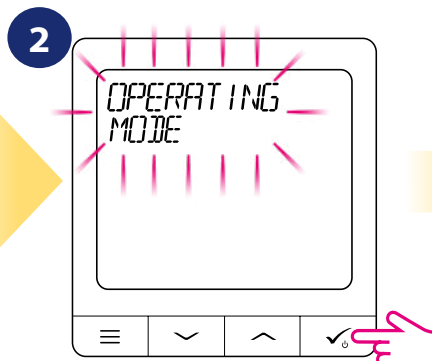

Press  to enter menu.

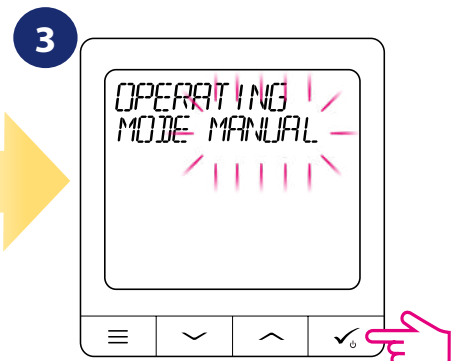

Using  or , choose parameter and then press .



Using  or , choose MANUAL and then press .

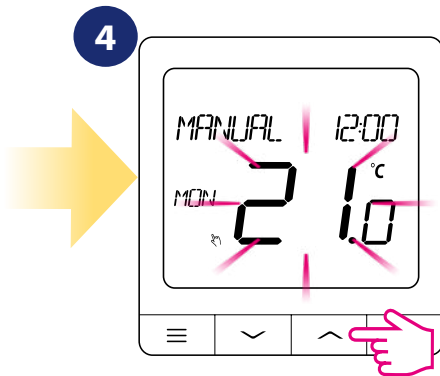

Using  or , set temperature.

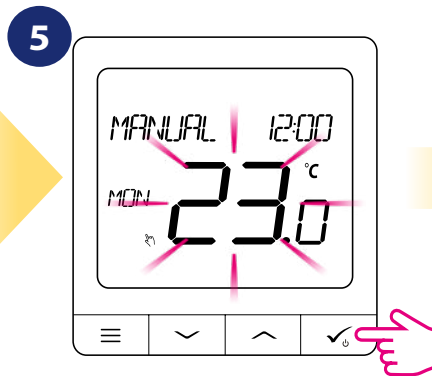

Confirm by .

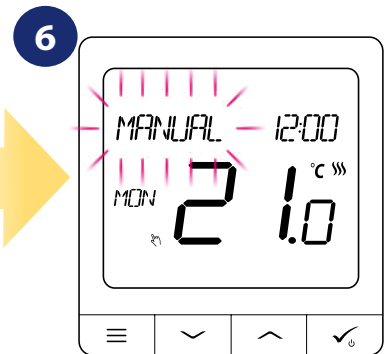

Thermostat work in MANUAL mode.

4.2 Schedule mode - programming schedule

In this mode, user can set the schedules for thermostat (temperature setpoints for specific periods of time). Programmed schedules should use all time periods.

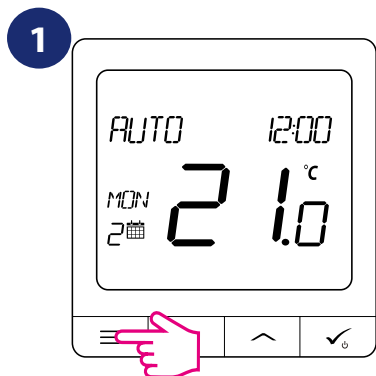

Press to enter menu.

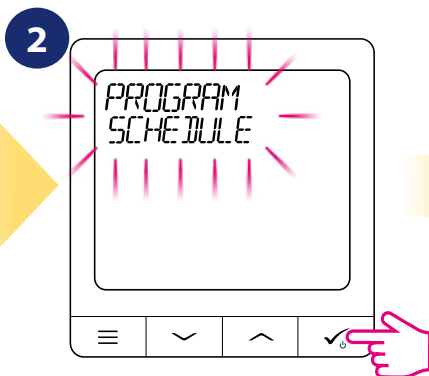

Using or , choose parameter and then press .

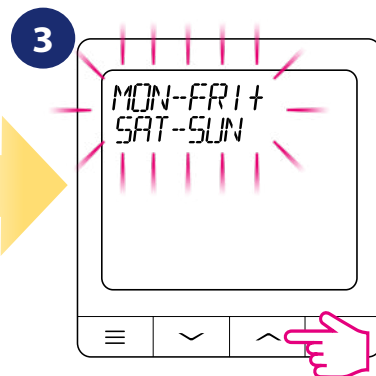

Using or , select the program type between: 5 + 2 (schedule for the working days and for the weekend)



All week
(set one schedule for the entire week)

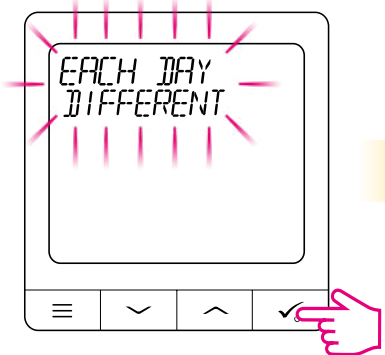

Each day different
(daily schedules). Confirm your selection by .

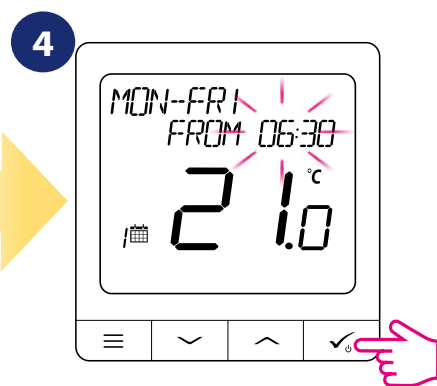

Using or , set the hour and then press .

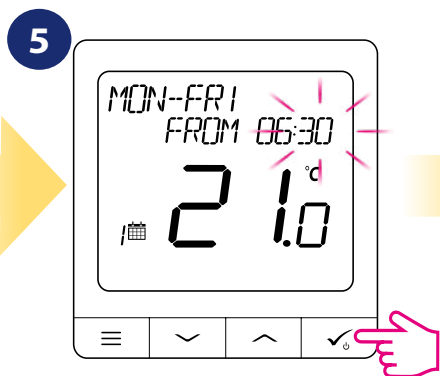

Using or , set the minutes and then press .

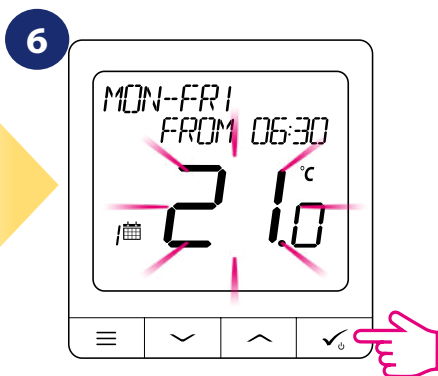

Using or , set the temperature and then press .



PLEASE NOTE! Thermostat should be set in AUTO mode to work according to the programmed schedule. Please refer to chapter 5.9.



Repeat the process for all time periods.

4.3 Temporary override mode

When thermostat is running schedule mode we can temporarily override it by setting new setpoint temperature.

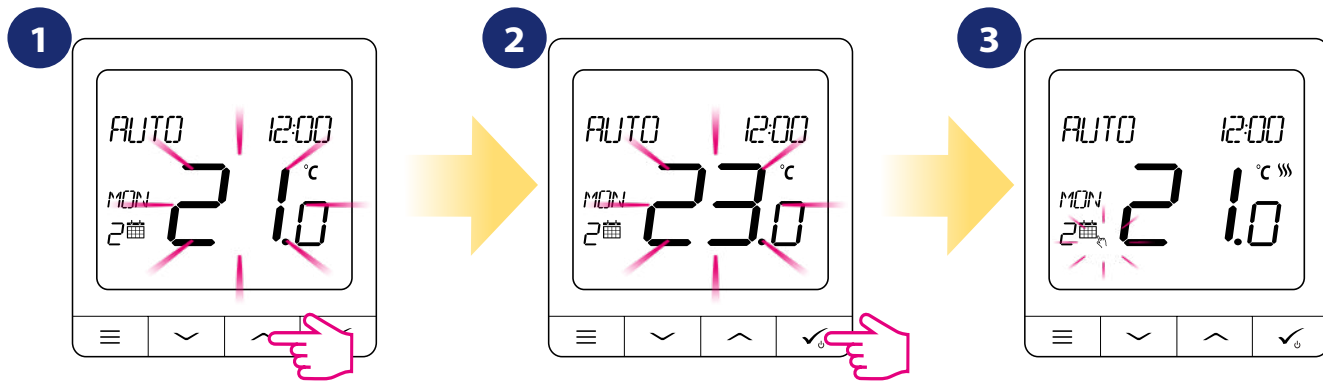

Using \downarrow or \uparrow , set temperature during active schedule.

Confirm by \checkmark button.

Thermostat works in temporary override mode.



PLEASE NOTE: To cancel temporary override mode and go back to the schedule hold \equiv button for 3 seconds. The calendar icon indicates that thermostat went back to schedule mode.

4.4 OFF mode

In this mode thermostat is turning off and maintain frost protection temperature (please refer to 4.6.10 chapter).

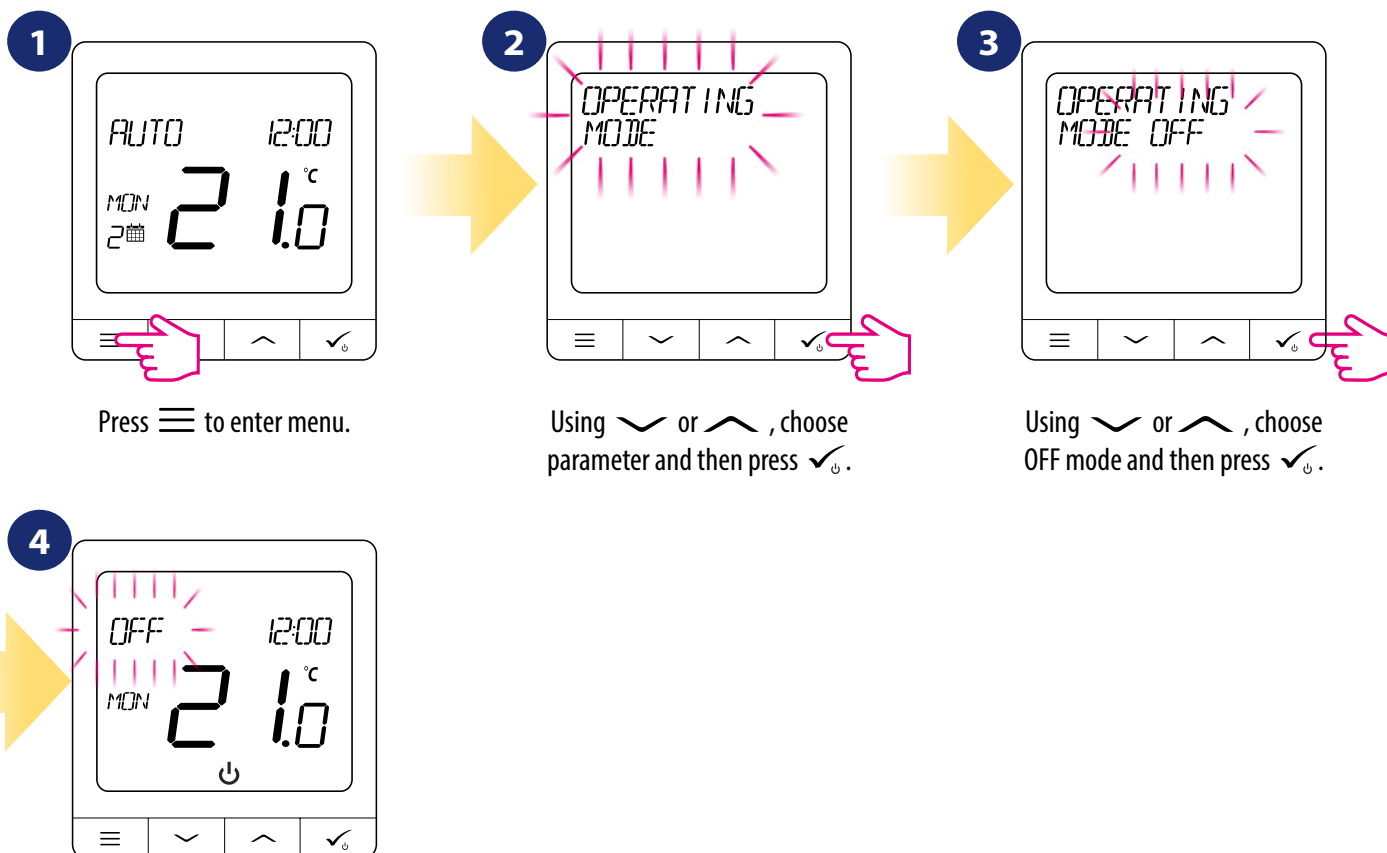

Press \equiv to enter menu.

Using \downarrow or \uparrow , choose parameter and then press \checkmark .

Using \downarrow or \uparrow , choose OFF mode and then press \checkmark .

Thermostat works in OFF mode.

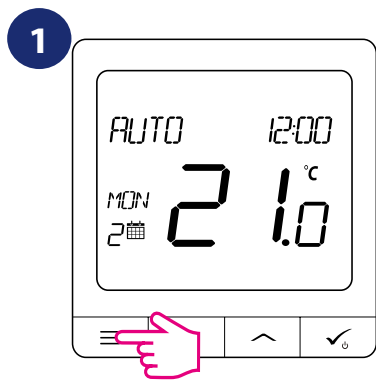

4.5 Language

To choose language follow steps below:

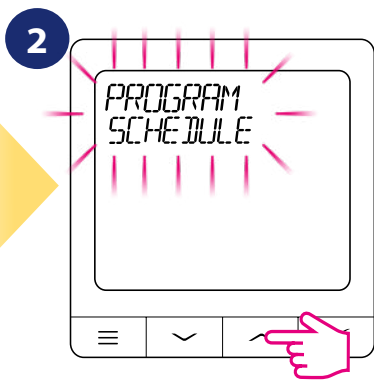

Press  to enter menu.



Using  or  move between parameters.

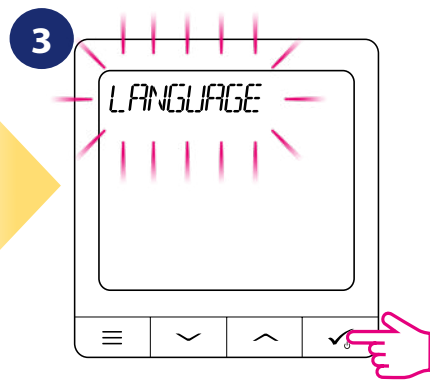

Press  to enter language settings.

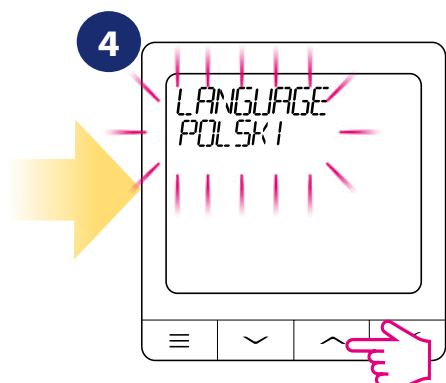

Using  or  choose your language.

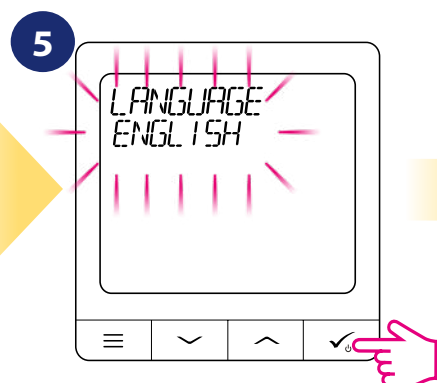

Press  to confirm.

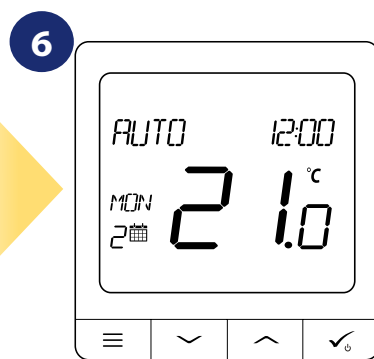

Thermostat will go to the main screen with saving the changes.

4.6 Advanced settings

In advanced settings user can set eg. temperature calibration, DST or PIN code etc. Remember that these are installer settings!

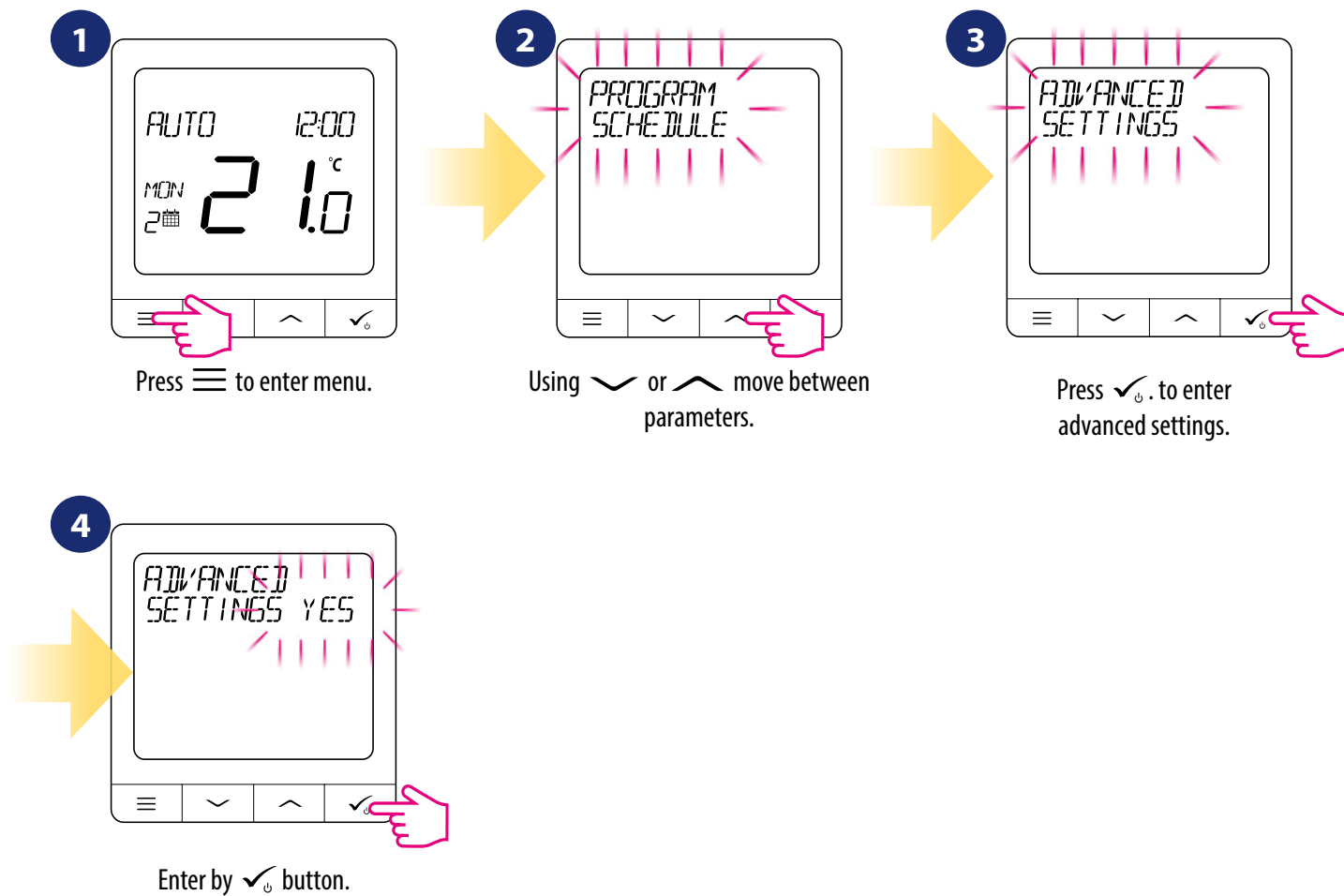

4.6.1 DST (Daylight Saving Time) setting

When DST function is ON then thermostat will automatically change time in summer time period.

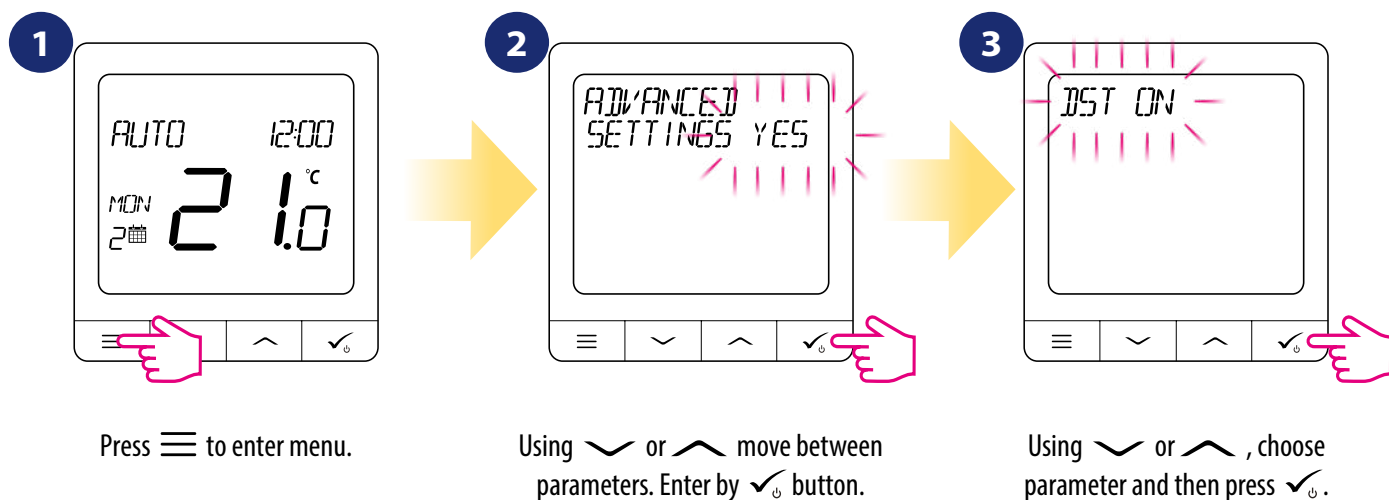

4.6.2 Display temperature accuracy

Adjust the measured thermostat temperature display scale for about 0,5 °C or 0,1 °C. Please follow steps below:

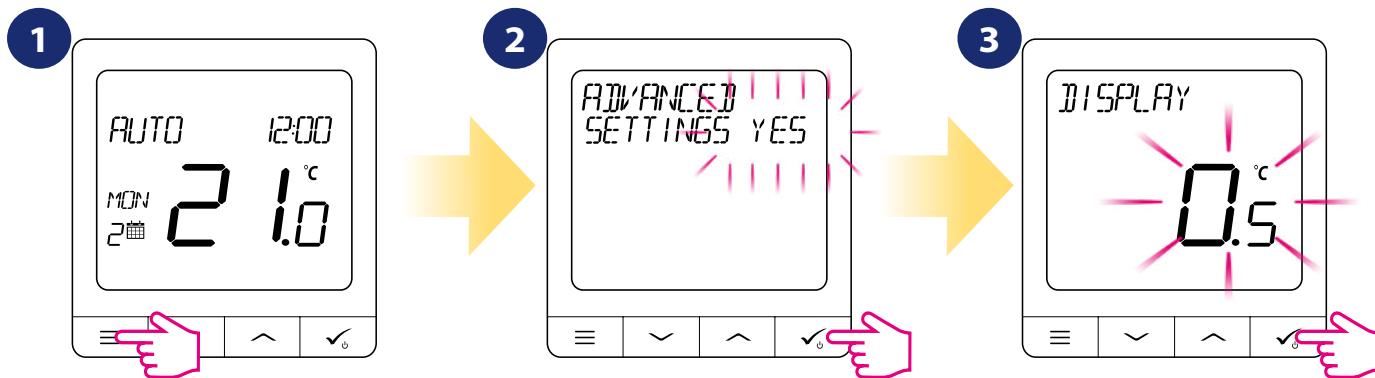

Press to enter menu.

Using or move between parameters. Enter by button.

Using or , choose parameter and then press .

4.6.3 PIN Code

Set PIN code to lock possibility to control the thermostat until you enter the code.

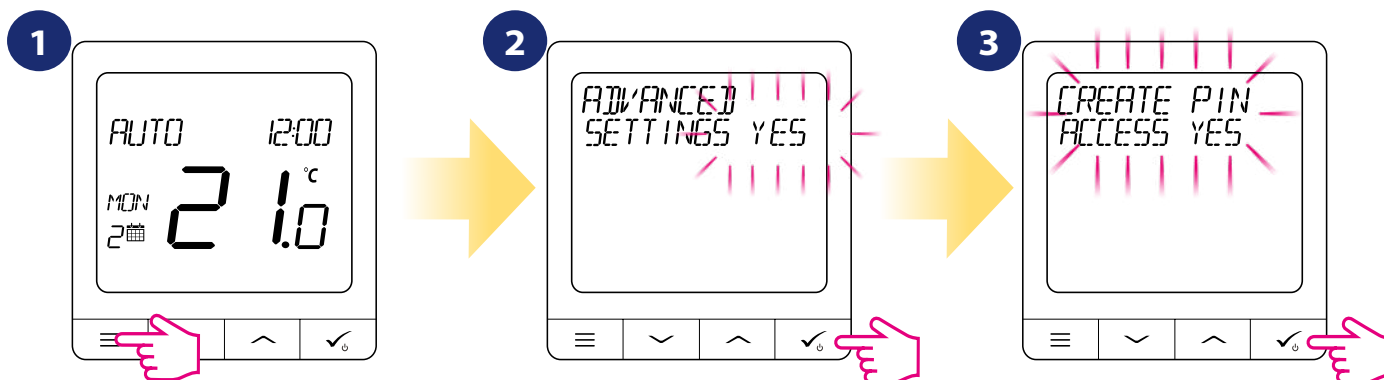

Press to enter menu.

Using or move between parameters. Enter by button.

Using or , choose parameter and then press .

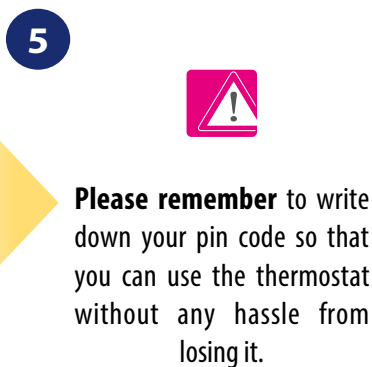
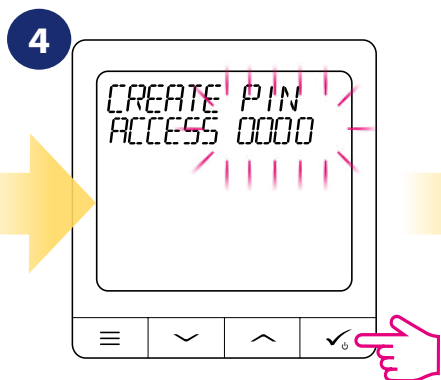

Using or set PIN code. Confirm each number by button.
Note: The first PIN code entry is also the setting of a NEW PIN CODE which must be entered each time to enter the ADVANCED (Admin) menu.

4.6.4 Service alert

Set a service reminder on the thermostat that will warn the tenant when the boiler is due its annual service.

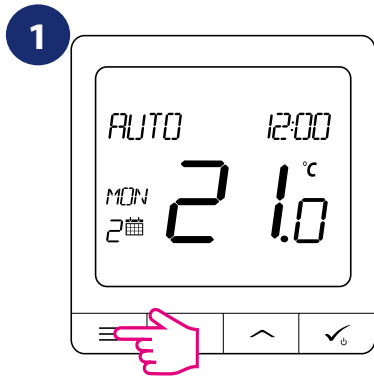

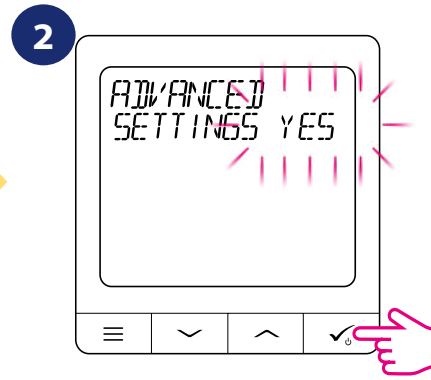

Press  to enter menu.



Using  or  move between parameters. Enter by  button.



Using  or , choose YES and then press .



Using  or  move between parameters. Confirm by  button.

4.6.5 Optimum Start

The optimization function is an energy-saving algorithm used for efficient control of the heating device, ensuring better thermal comfort at certain times of the day. When the OPTIMUM START function is active, the thermostat sends a heating signal to the heat source beforehand so that the preset temperature in the room is reached at the time specified in the schedule.

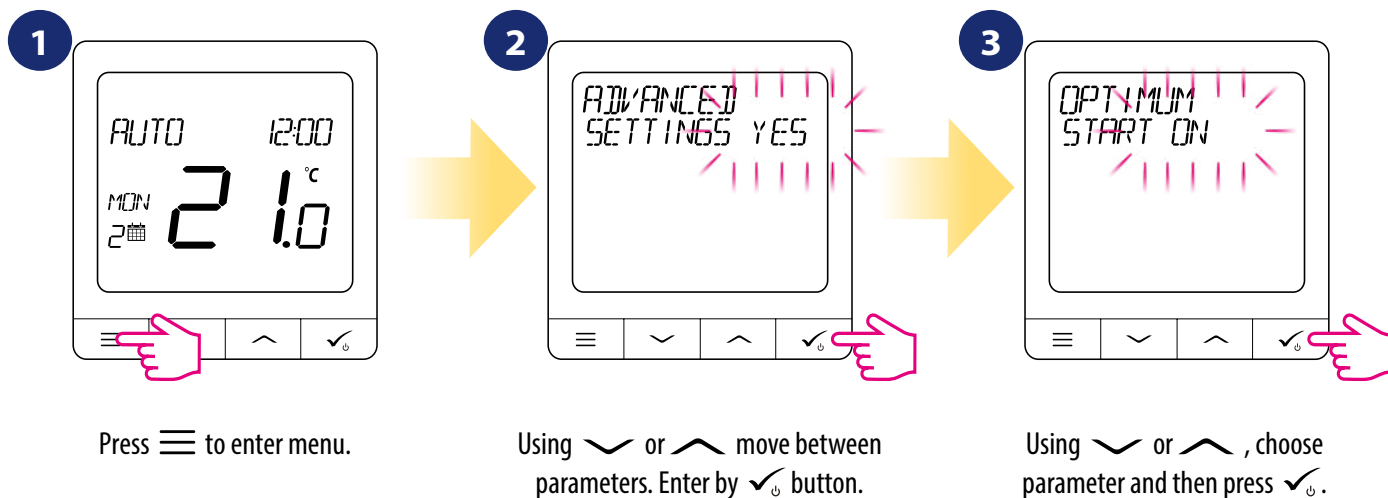

4.6.6 Optimum Stop

When the OPTIMUM STOP function is active, the thermostat, taking into account the inertia of the system, switches off the heat source earlier, keeping the temperature set in the schedule.

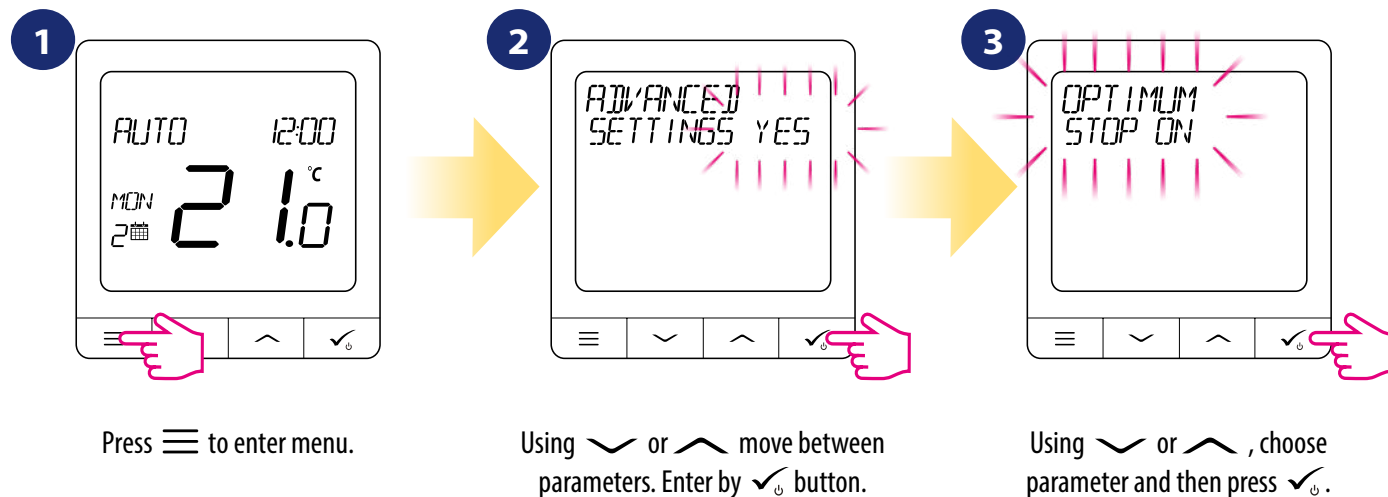

4.6.7 Thermostat temperature calibration

Thermostat calibration is a function which allows user to recalibrate internal thermostat's temperature sensor by a given number of degrees (in the range from -3,5 °C to 3,5 °C). To calibrate thermostat's temperature sensor please follow steps below:

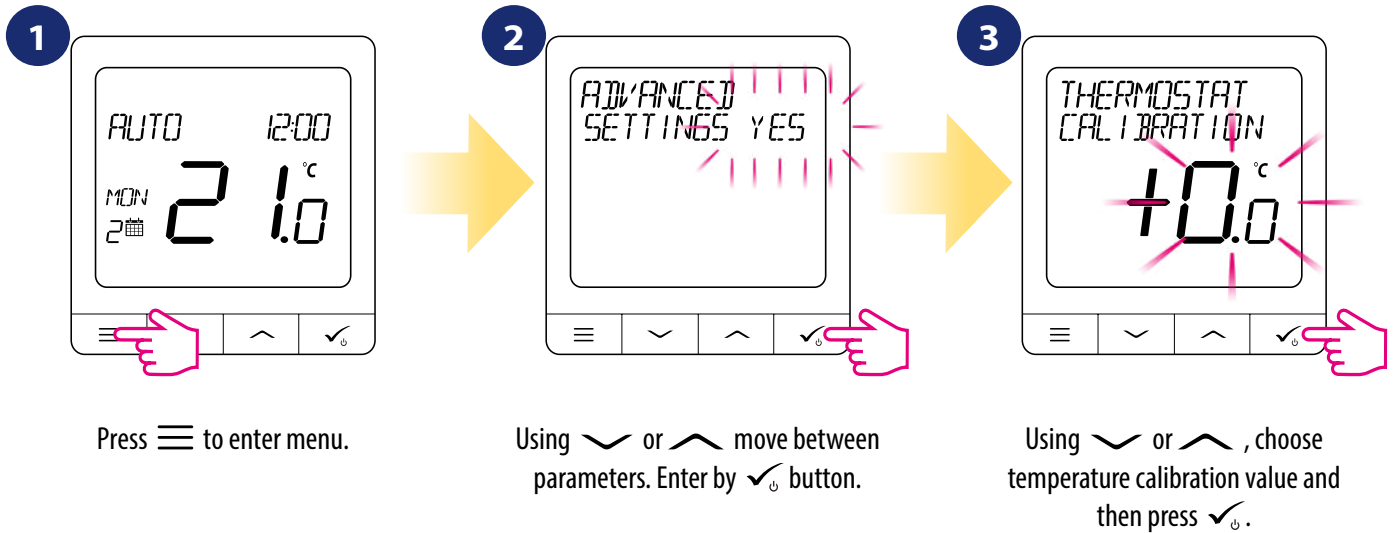

4.6.8 Minimum setpoint temperature

This parameter allows to limit temperature setpoint range by setting minimum setpoint for heating mode. Default temperature setting range: 5°C - 35°C

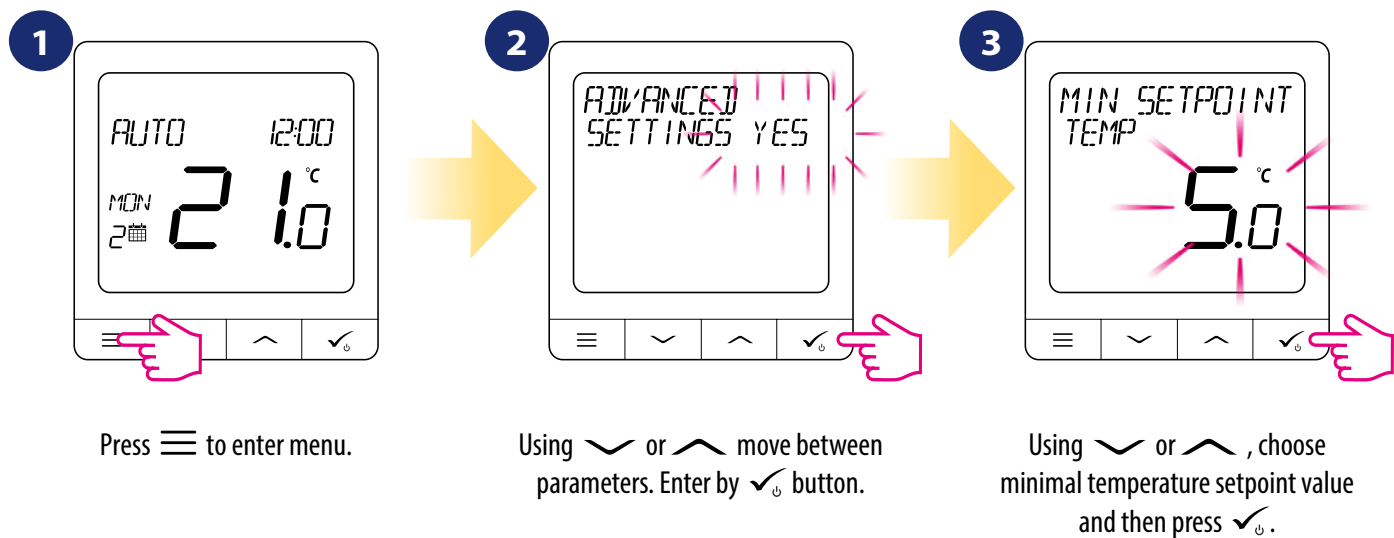

4.6.9 Maximum setpoint temperature

This parameter allows to limit temperature setpoint range by setting maximum setpoint for heating mode. Default temperature setting range: 5,5°C - 35,0°C

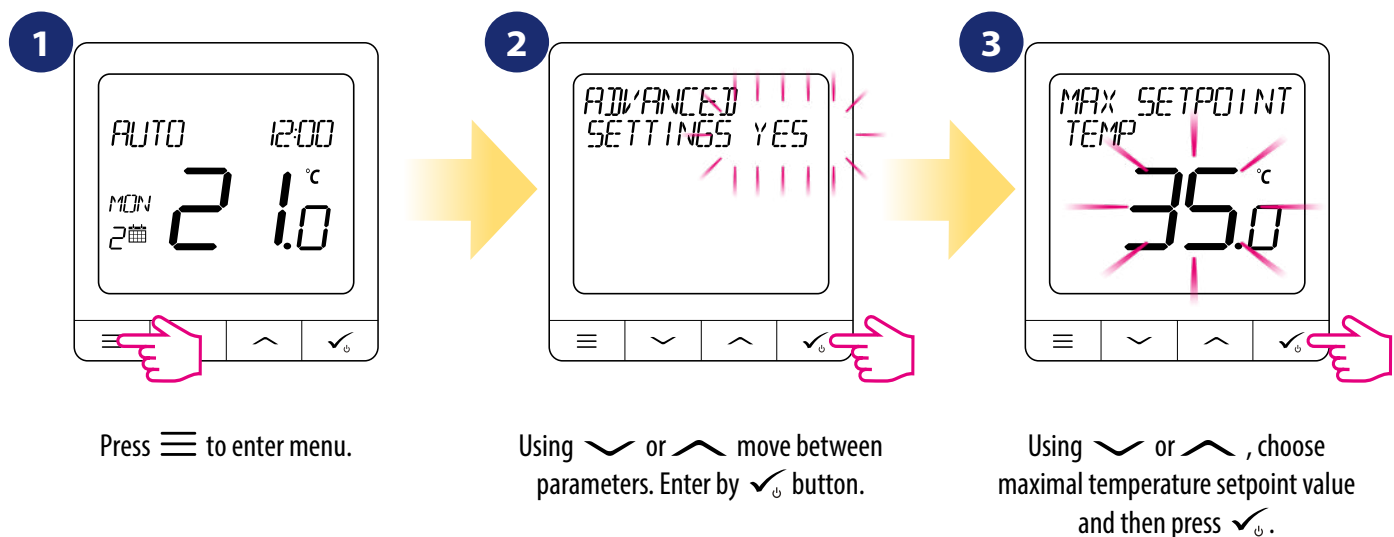

4.6.10 Frost protection temperature

Set temperature for frost protection mode.

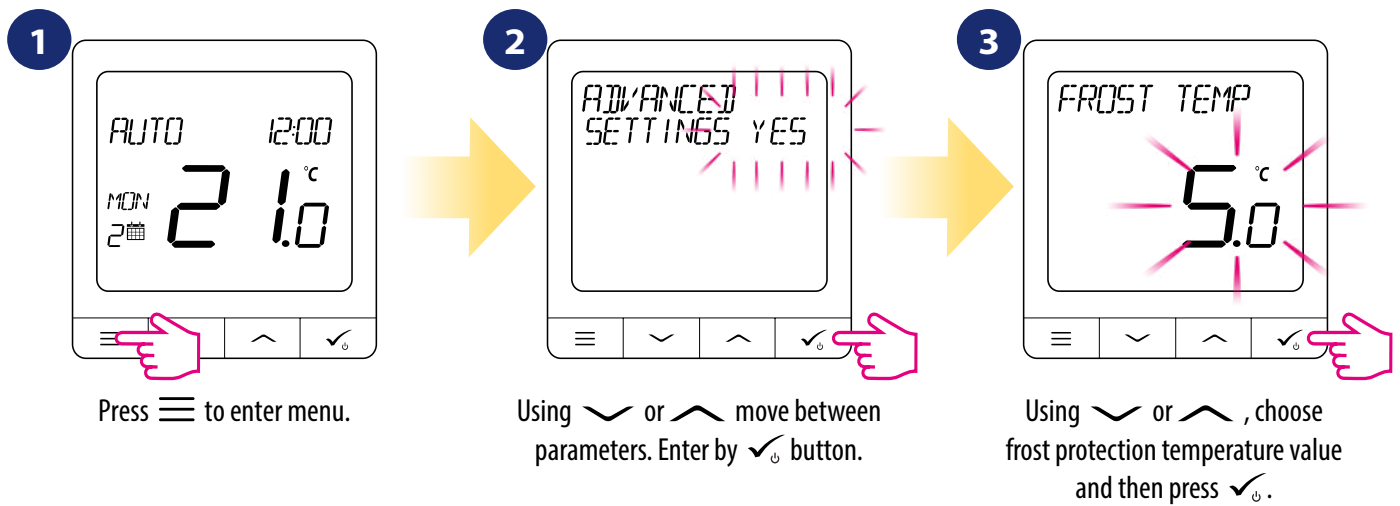

4.6.11 Control algorithm

Set control algorithm: ITLC for radiators, SPAN (hysteresis) 0,5°C or SPAN (hysteresis) 0,25°C.

ITLC is a self-learning, time-proportional control algorithm. The regulation of the ITLC type ensures economical operation system due to more precise temperature maintenance during the controlling process. In addition to an accurate and stable room temperature, the advantage of this system is the minimization of energy consumption and significant savings.

Hysteresis is the temperature difference between which the thermostat works, keeping the set temperature. For example, if you set the temperature to 20°C and if the hysteresis is $\pm 0.5^\circ\text{C}$, the heating will be turned on when the room temperature drops to 19.5°C and turned off when the temperature reaches 20.5°C.

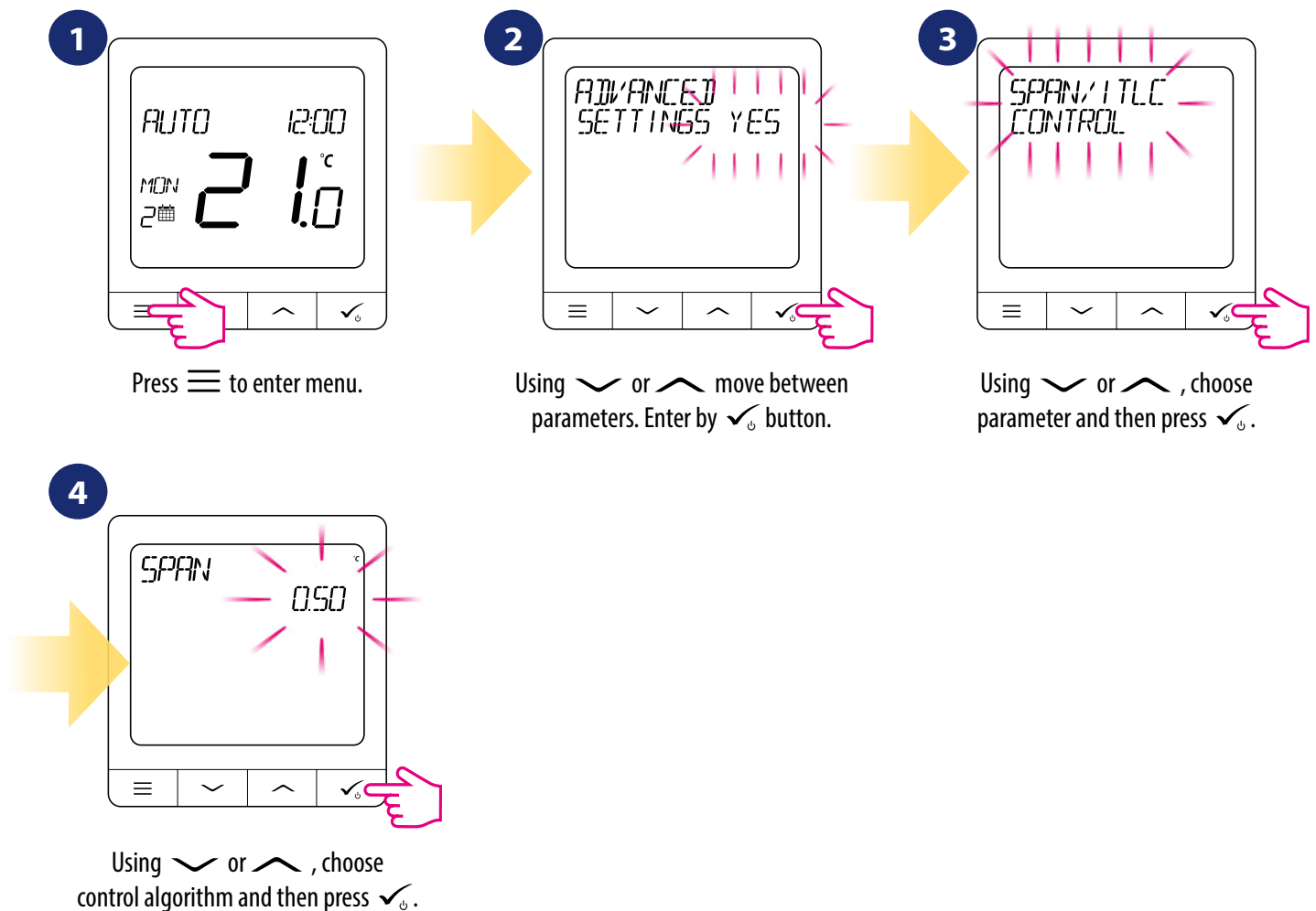

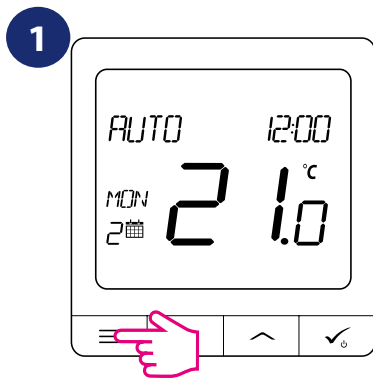

4.7 Holiday mode

Holiday mode is a special program temperature setpoint which thermostat will maintain for specified days. During holiday mode thermostat is maintaining frost protection setpoint temperature. How to set **HOLIDAY MODE**:





Press  to enter menu.





Using  or , choose parameter and then press .



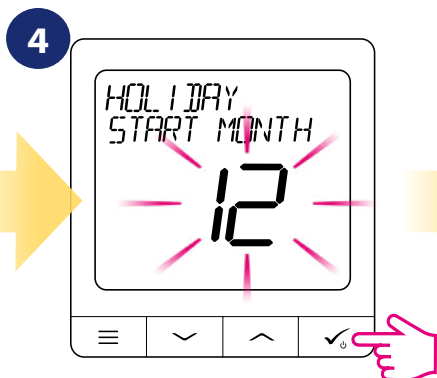

Using  or , set year and then press .



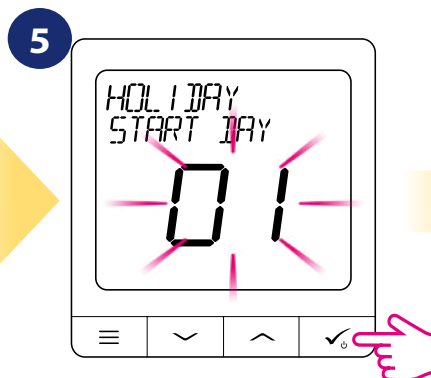

Using  or , set month and then press .



Using  or , set day and then press .



Using  or , set time and then press .

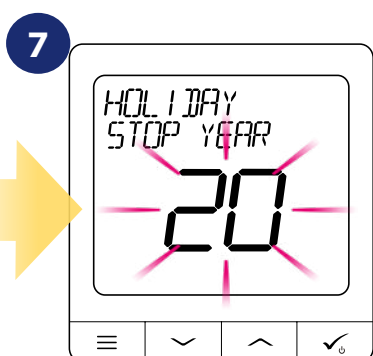

Now do steps from 3-6 to set when holiday mode should stop.

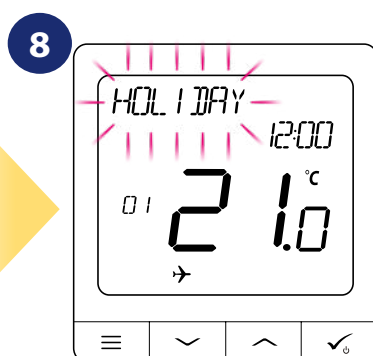



Thermostat will work in Holiday Mode during set period of time.

9 To cancel holiday mode you have to go to main menu and choose "CANCEL HOLIDAY" option and confirm.

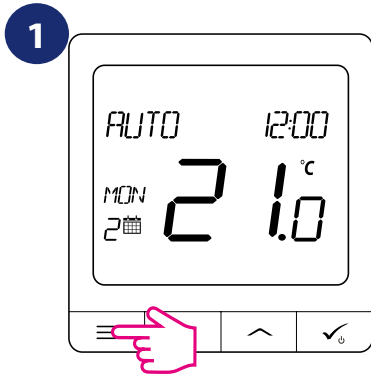

4.8 Time/Date

To set time/date follow steps below:





Press  to enter menu.

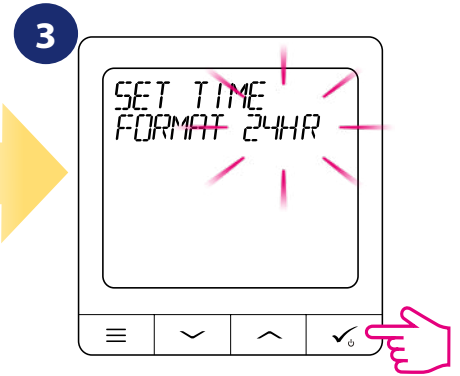

Using  or , choose parameter and then press .



Using  or , choose the time format. Press  to confirm.



Using  or , set the hour and then press .

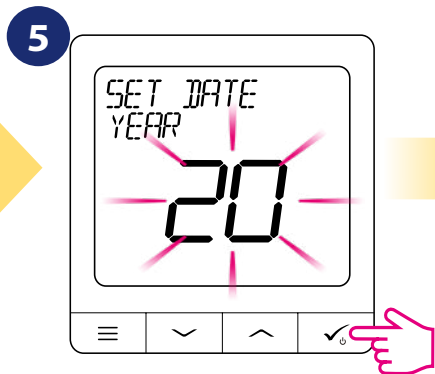

Using  or , set the year and then press .

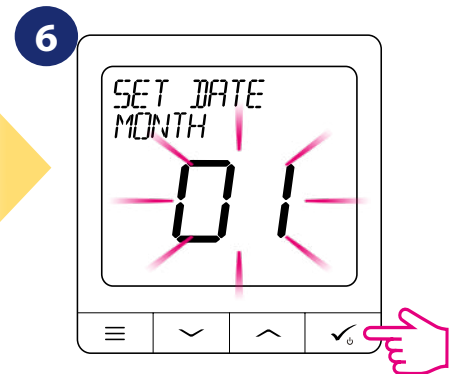

Using  or , set the month and then press .

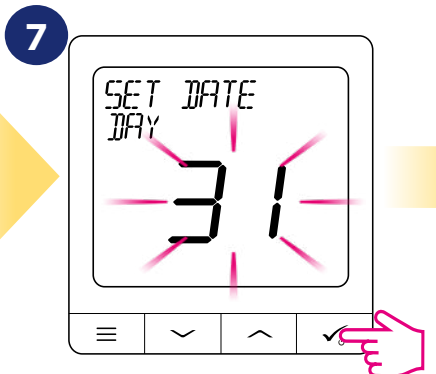

Using  or , set the day and then press .

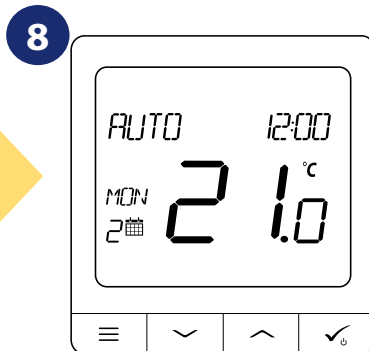

Thermostat will go to the main screen with saving all the settings.

4.9 BOOST hours - hourly temperature override

The function is available only in AUTO and OFF modes. Used to change the temperature to the desired value for a specified number of hours (up to 9 hours). After the elapsed time, the thermostat returns to the previous operating mode.

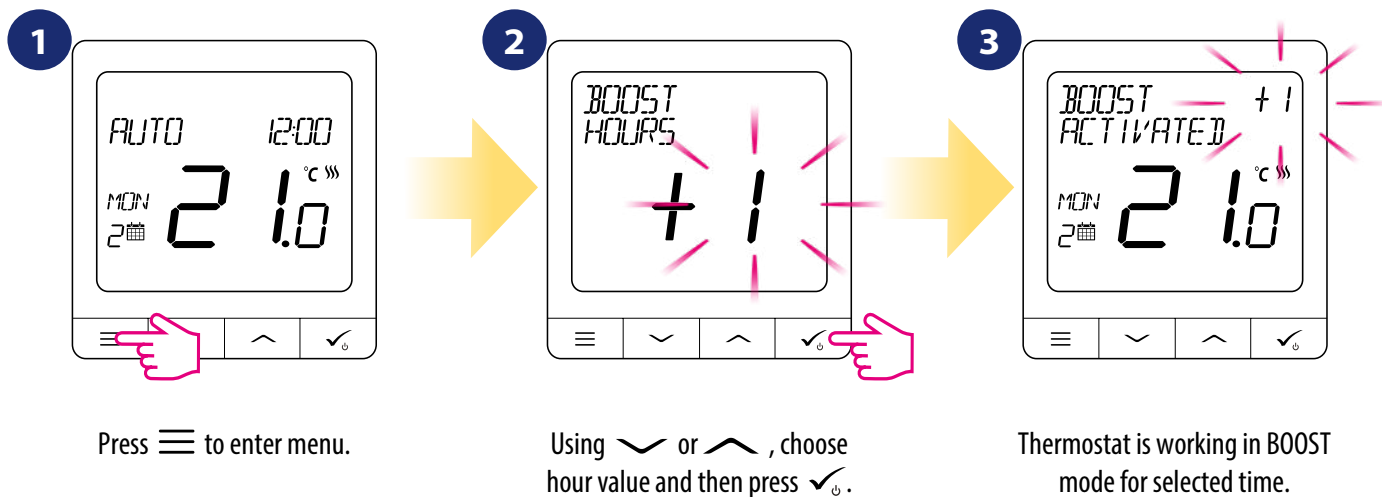

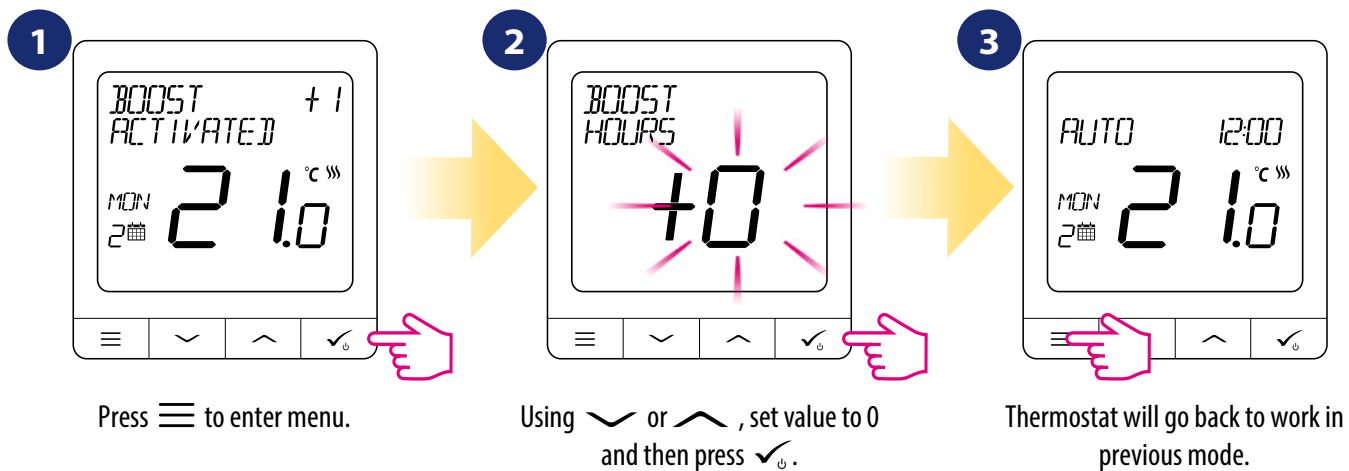

How to stop BOOST mode:





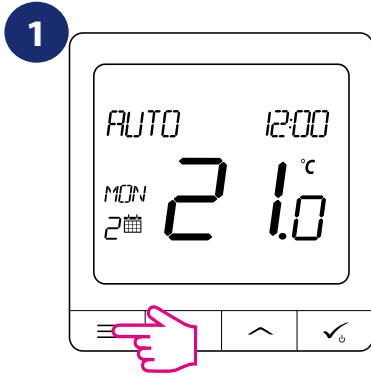

4.10 Operating mode

Select operating mode for thermostat: Manual mode, AUTO mode or OFF.

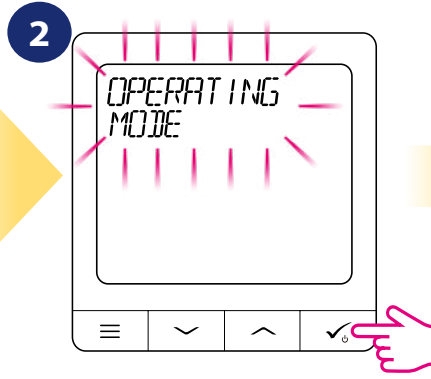



Press  to enter menu.

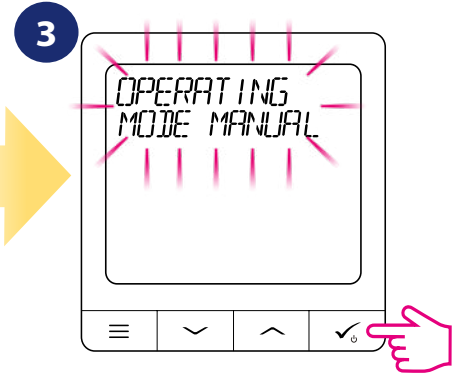

Using  or , choose parameter and then press .



Using  or , choose selected mode and then press .

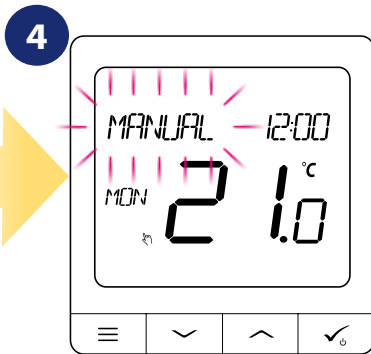

Thermostat will work in selected mode (AUTO, Manual or OFF).

5. Factory Reset

To RESET WQ610 thermostat to it's factory default settings please follow steps below:

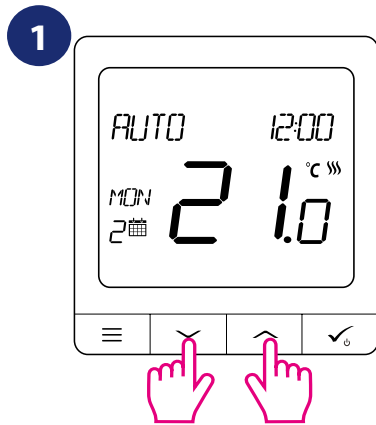

To reset the thermostat press and hold together + buttons for 5 seconds.

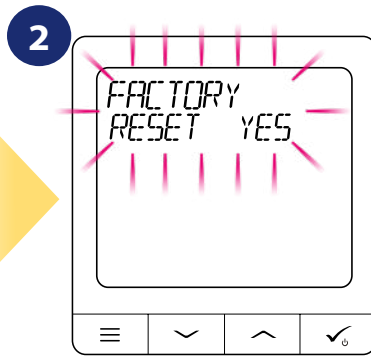

Using or , choose YES and then press .

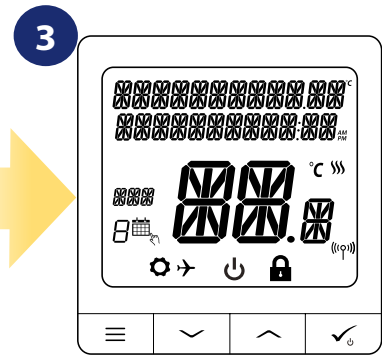

Thermostat has been reseted.

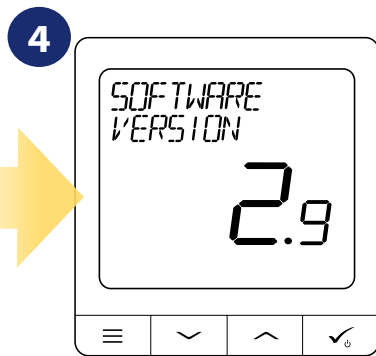

It will display firmware version...

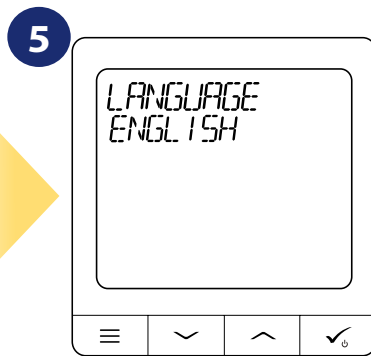

...and then it will go through all start settings.

6. Error codes



Thermostat will display errors only when it's connected to the boiler by OPENTHERM terminals (A / B). Please refer then to boiler manual. Each boiler can have different error codes.

ERRORS EXAMPLES:

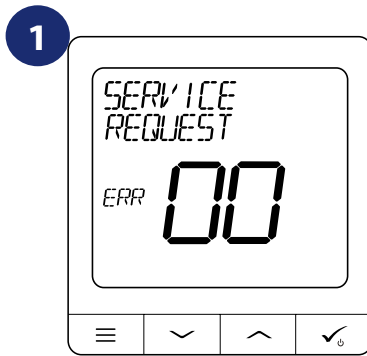

SERVICE REQUEST ERROR

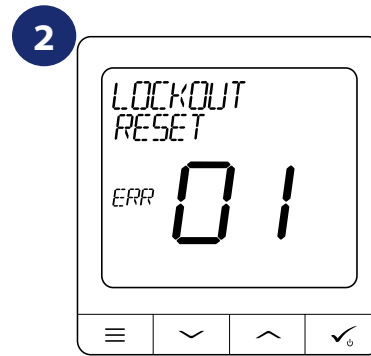

LOCKOUT RESET ERROR



LOW WATER PRESSURE ERROR

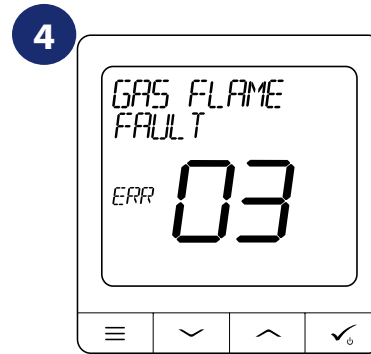

GAS FLAME FAULT ERROR

7. Cleaning and Maintenance

The **WQ610 thermostat** requires no special maintenance. Periodically, the outer casing can be wiped clean using a dry cloth (please DO NOT use solvents, polishes, detergents or abrasive cleaners, as these can damage the thermostat). There are no user serviceable parts within the unit; any servicing or repairs could only be carried out by **Salus Controls** or their appointed agents.

8. Technical Informations

Power supply	230V AC 50Hz
Rating max	3(1)A
Output signal	OpenTherm or COM/NO relay
Temperature range	5 - 35°C
Display temperature accuracy	0.1°C or 0.5°C
Control algorithm	ITLC or $\pm 0.25^\circ\text{C}$ or $\pm 0.5^\circ\text{C}$
Communication	Wired
Dimension [mm]	86 x 86 x 28

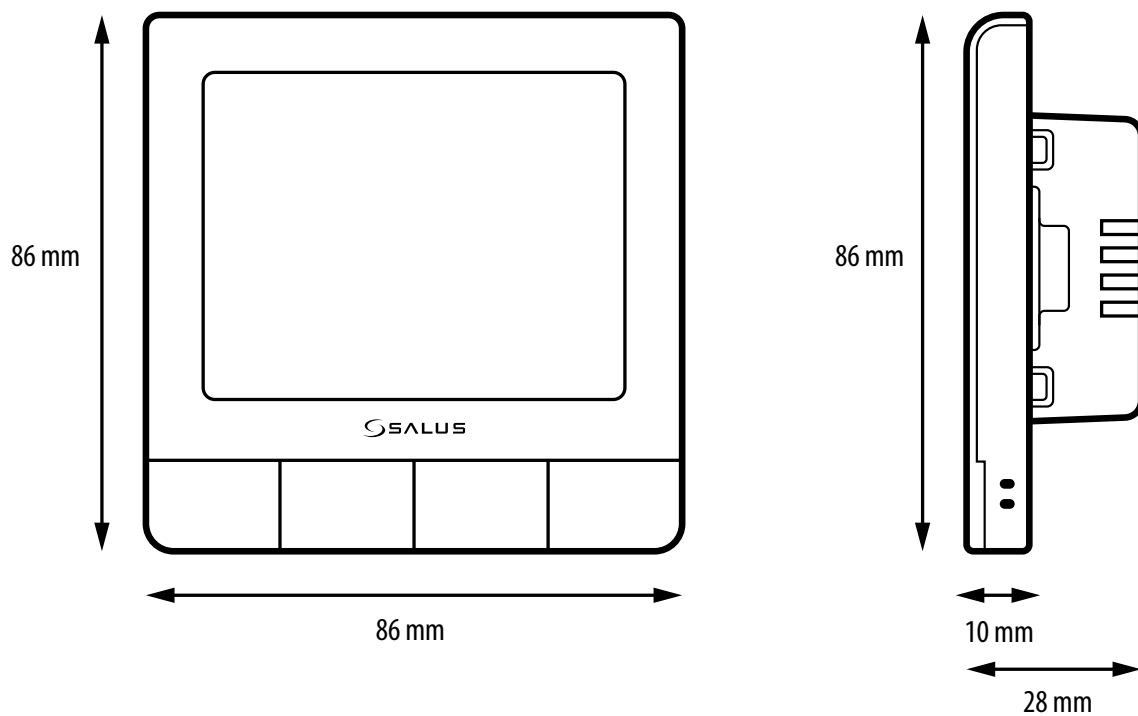

9. Warranty

SALUS CONTROLS warrants this product to be free from any defects in material or workmanship and to perform as specified for a period of five years from the date of installation. SALUS CONTROLS reserves the sole responsibility for breach of this warranty by repairing or replacing the defective product. This product includes software that matches the distributor's identification at the time of sale. The manufacturer / distributor provides a guarantee covering all functions and specifics of the product in accordance with this marking. The distributor's warranty does not cover the correct operation of the functions and features available as a result of a product software update.

The full warranty conditions are available at www.salus-controls.eu

Customer Name:

Customer Address:

..... Post Code:

Tel No: Email:

Company Name:

Tel No: Email:

Installation Date:

Installer Name:

Installer Signature:

PRODUCER:

Salus Limited

6/F, Building 20E, Phase 3, Hong Kong

Science Park, 20 Science Park East Avenue,

Shatin, New Territories, Hong Kong



www.saluscontrols.com

SALUS Controls is a member of the Computime Group.

Maintaining a policy of continuous product development SALUS Controls plc reserve the right to change specification, design and materials of products listed in this brochure without prior notice.

Ver. 5

Issued: 04 V 2021

Soft version: 2.9

