

VS20BRF- SCHEME VEZAVE

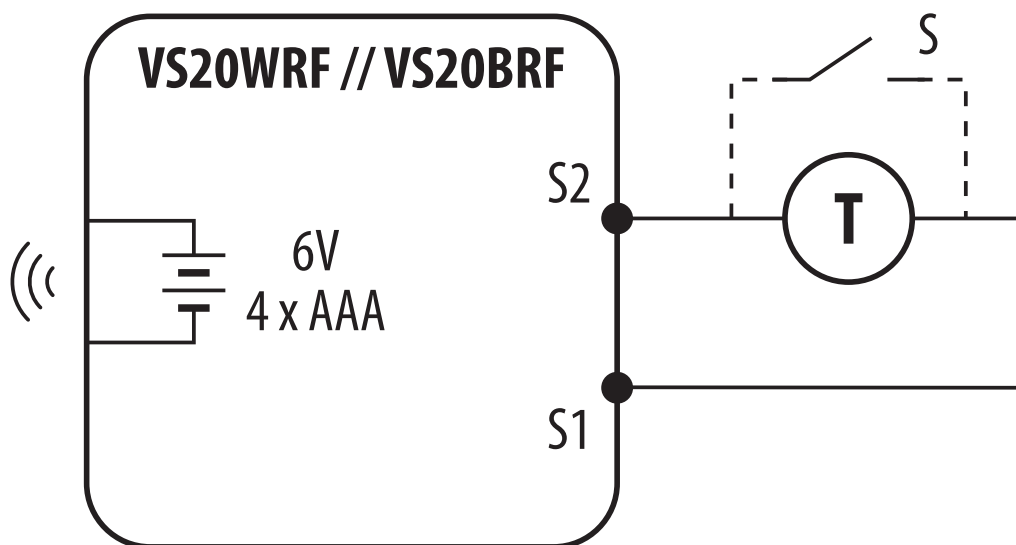

LEGENDA (Ikone)

	Baterijsko napajanje		Brezžična komunikacija
L, N	Napajalna napetost 230 V AC		Črpalka
	Varovalka		Pogon ventila
COM, NO, NC	Breznepetostni izhodni kontakti		Temperaturno tipalo
S, S1, S2	Oznaka vhoda		3-stopenjski ventilator 230 V AC
SL	Napetostni izhog 230 V AC		Žarnica ali druga obremenitev
	Navadno odprti kontakt		Termoelektrični pogon
	Navadno zaprti kontakt		Programabilni časovnik
	Preklopni kontakt NC/COM/NO		Zunanji kontakt za zapiranje
	Kotel - Priklop kotla* - Kontakti v kotlu za priklop termostata ON/OFF (sladno z navodili za uporabo kotla)		Transformator