



VS10WRF/VS10BRF THERMOSTAT - FULL USER MANUAL

SALUS[®]
CONTROLS

TABLE OF CONTENTS

1. Introduction	5
1.1 Product Compliance	5
1.2 Safety Informations	5
2. Product Overview	6
2.1 Montage	6
2.2 Package content	6
2.3 Proper thermostat location	6
2.4 Connection Description (VS10WRF/VS10BRF thermostat)	6
3. About ZigBee network	7
3.1 ZigBee network - creation and work	7
3.2 Compatibility with SALUS devices (ONLINE AND OFFLINE)	8
4. Before you start (first power up)	9
4.1 LCD icon description	9
4.2 Button description	9
4.3 First power up sequence, language choice and preparing to the pair process	10
5. Installation by SALUS Smart Home application (ONLINE MODE)	11
5.1 General informations about SALUS Smart Home application	11
5.2 Configuration as a programmable thermostat	12
5.2.1 Pairing with underfloor heating wiring centre (KL08RF/Control Box)	12
5.2.2 Pairing with wireless TRV radiator head	15
5.2.3 Pairing with Smart Plug SPE600	17
5.2.4 Pairing with Smart Relay SR600	19
5.2.5 Pairing with RX10RF receiver	21
5.3 Configuration as a hot water timer	23
5.3.1 Pairing with Room Extension Receiver (RX2)	23
6. OPERATING in ONLINE MODE (by app)	25
6.1 General informations	25
6.2 App icons description	25
6.2.1 Programmable thermostat	25
6.2.2 Hot Water Timer	26
6.3 Change thermostat name (pencil icon)	27
6.4 Work as a programmable thermostat	28
6.4.1 Setpoint temperature change	28
6.4.2 Heat/Cool mode change (KL08RF connection)	29
6.4.3 Thermostat modes	30
6.4.3.1 Schedule mode	30
6.4.3.2 Temporary override mode	34
6.4.3.3 Manual mode	34
6.4.3.4 Frost protection	35
6.4.4 Key lock function	36
6.4.5 Compatibility with window/door sensor OS600 / SW600	37
6.4.6 Compatibility with Smart Plug SPE600	38
6.4.7 Compatibility with Smart Relay SR600	39
6.5 Work as a hot water timer (work modes)	40
6.5.1 Turned ON mode - I	40
6.5.2 AUTO mode - A	41
6.5.3 Turned OFF mode - O	42
6.5.4 Temporarily ON mode - B	43

6.6 Identification mode.....	44
6.7 Pinning/unpinning thermostat to/from application dashboard	45
6.8 User settings (basic settings).....	46
6.9 Admin settings (installer parameters).....	47
6.10 OneTouch rules (add/edit)	48
6.11 Error codes (exclamation mark in app)	52
6.12 Wireless signal strength test.....	53
6.13 Factory reset (removing thermostat from the app and ZigBee network)	54
7. Installation in OFFLINE MODE without SALUS SmartHome application	56
7.1 General informations	56
7.2 Pairing with underfloor heating wiring centre (KL08RF/Control Box).....	57
7.2.1 Available operation modes.....	57
7.2.2 Grouping - installation of the thermostat as a group controller - MASTER - or as a group thermostat (SLAVE).....	60
7.2.3 Installation as a programmable thermostat.....	62
7.2.4 Replace the zone assigned to another thermostat	63
7.3 Pairing with wireless TRV radiator head	64
7.4 Pairing with RX10RF receiver.....	66
7.5 Configuration as a Hot Water timer	67
7.5.1 Pairing with Room Extension Receiver (RX2)	67
8. OPERATING in OFFLINE MODE.....	69
8.1 Work as a programmable thermostat.....	69
8.1.1 Work modes	69
8.1.2 Heat/cool mode change (KL08RF connection).....	70
8.2 Work as a hot water timer with RX10RF receiver	71
8.2.1 Work modes	71
8.3 User settings (basic settings).....	72
8.3.1 Schedule mode - programming schedule.....	72
8.3.2 Time/Date	74
8.3.3 Thermostat calibration	75
8.3.4 Key lock function.....	76
9. Installer parameters	77
10. Factory Reset	79
11. Error codes (error codes description with possible solutions)	80
12. Cleaning and Maintenance	83
13. Technical Informations	83
14. Warranty	84

1. Introduction

1.1 Product Compliance

This product complies with the essential requirements and other relevant provisions of Directives 2014/53/EU and 2011/65/EU. The full text of the EU Declaration of Conformity is available at the following internet address: www.saluslegal.com.

1.2 Safety Informations

- Before starting installation work and before using the product, read the entire manual.
- The information contained in the instructions is essential for proper functioning.
- To avoid accidents resulting in personal injury and material damage, please follow all safety precautions, specified in this manual.
- The device should not be used by people with limited mental, sensory or mental abilities, without experience, of insufficient knowledge as well as children.
- Do not use an unassembled device (eg without a cover).
- The device may only be opened by a qualified person.
- Keep electrical devices out of the reach of children and ensure that they do not play with it. Children should not be left unattended. If necessary, disconnect the control system for the entire room.
- Do not leave the packaging, cabinet, or any loose parts of the device unattended, as they pose a risk to children.

WARNING!

- Installation must be carried out by a qualified person with appropriate electrical qualifications in accordance with standards and regulations in force in the given country and in the EU.
- Never try to connect the device other than as described in the manual.
- Before assembly, repair or maintenance as well as during any connection works it is absolutely necessary disconnect the mains supply and make sure that the terminals and electric wires are not live.
- The device may not be exposed to extreme temperatures, strong vibrations or subjected to mechanical shock.
- The device should not be used in unfavorable environmental conditions or in rooms where there is a concentration of flammable gases, fumes or dust.

WARNING!

- There may be additional protection requirements for the entire installation that the installer is responsible for maintaining.



Care for the natural environment is of paramount importance to us. The awareness that we manufacture electronic devices obliges us to dispose of used electronic components and devices safely. Therefore the company has received a registration number issued by the Chief Inspector for Environmental Protection. The crossed out symbol the trash can on the product means that the product must not be disposed of with ordinary waste containers. Sorting waste for recycling helps to protect the environment. It is the user's responsibility to surrender used equipment to a designated collection point for recycling waste from electrical and electronic equipment.

2. Product Overview

VS10WRF / VS10BRF is a room temperature thermostat that is used for wireless control of iT600 series devices such as: KL08RF wiring centre, TRV radiator valve and RX10RF boiler receiver. In combination with Universal Gateway UGE600 this regulator can be controlled over the Internet using SALUS SmartHome app (Online mode). Without Internet connection (Offline mode) thermostat works locally, but its communication with other devices must be done through the coordinating unit - C010RF.

2.1 Montage

2.2 Package content

- 1) VS10WRF/VS10BRF thermostat
- 2) Short instructions
- 3) Mounting screws



2.3 Proper thermostat location

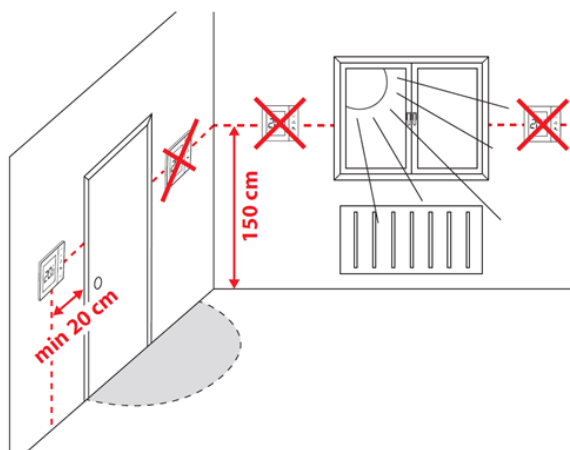

Please note:

The ideal position to thermostat mounting is about 1,5m under floor level far from heating or cooling sources. Thermostat can't be exposed to sunlight or any extreme conditions like for example draft.

Because of fire and explosion risk there is not allowed to use thermostat in atmosphere of explosive gases and flammable liquids (eg coal dust). In case if any of listed dangers occur you have to use additional protection measures – anti-dust and explosive gases (tight cover) or prevent their formation. Furthermore, thermostat can't be used in condensation of water vapor conditions and be exposed to water action.

Wall mounting

Mounting: to mount thermostat you can use accessories included with the set (mounting screws). Remove back cover to mount the plate to the wall. Now please insert the batteries inside the thermostat. After this just attach thermostat to the plate right into designed holes in the plate.

2.4 Connection Description (VS10WRF/VS10BRF thermostat)

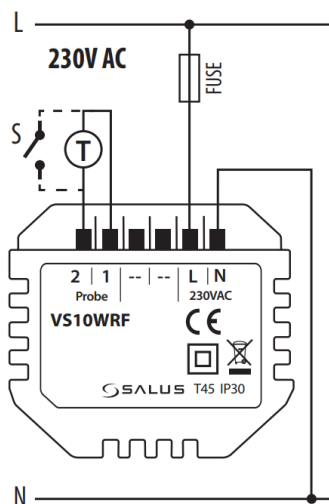

Symbols explanation:

- S – volt-free contact
- T – temperature sensor eg. FS300
- L, N – power supply 230V AC

1, 2 terminals:

- air or floor temperature sensor
- external volt-free contact to connect any ON/OFF switch or occupancy sensor (Hotel card)
- external hot water thermostat

3. About ZigBee network

3.1 ZigBee network - creation and work

ZigBee is a wireless network based on IEEE 802.15.4 standard and its communication takes place in the 2.4 GHz band. The network is based on a mesh topology, which allows for a very large range and high reliability. The maximum range of direct communication between two network nodes (devices) is about 100m in open space.

The devices included in the ZigBee network are divided into three types:

- **coordinator** - there can only be one such device in each network. It acts as a connection node for all devices;
- **router (repeater)** - this device is powered by 230VAC, with functionality similar to classic network routers, and its task is to forward data packets and increase the range of the network;
- **terminal device** - battery powered, sends data to the coordinator (also through the router) to which it is connected. It is usually put to sleep temporarily, which helps reduce energy consumption.

Built-in security in the ZigBee protocol (ISO-27001 and SSAE16 / ISAE 3402 Type II - SOC 2 certification) ensure high transmission reliability, detection and removal of transmission errors, as well as connectivity between established priority devices.

Security measures include:

- devices authenticated using a unique key pair;
- encrypted communication between the mobile application and the device;
- data encryption - HTTPS encrypted using TLS, UDP channel with AES-128 encryption;
- layered access control to prevent tampering with one device threatening the entire system.

The ability to work many devices at a short distance from each other was achieved through the use of radio transmission of the spread spectrum signal. The main advantages of devices working in the ZigBee system are two-way communication and minimization of energy consumption, which in many cases allows them to be powered from 230V AC.

Four Simple steps to create ZigBee network:

- 1.** **Coordinator Installation - Universal Gateway** for **ONLINE** and **OFFLINE** systems with internet application or **CO10RF** for only **OFFLINE** systems without application.



- 2.** **Now** - add any device you want **powered 230VAC**. **Note** to locate it as near coordinator as possible.

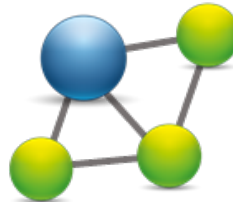

- 3.** Now you can increase range of ZigBee network by adding more devices **powered 230 VAC**.

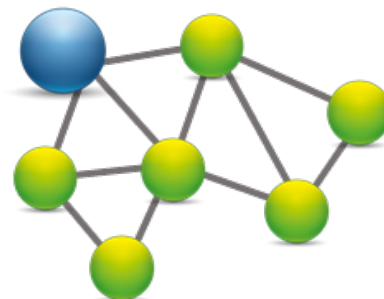

- 4.** To extend your network you can add more battery devices and accessories.

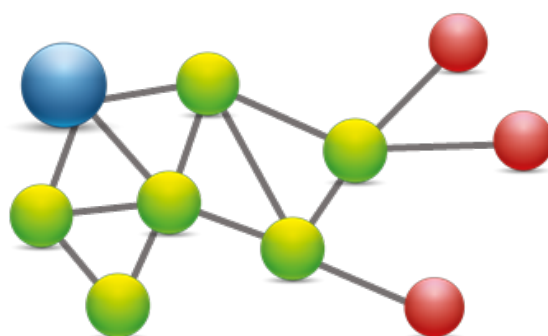

3.2 Compatibility with SALUS devices (ONLINE AND OFFLINE)

COMPATIBILITY WITH OTHER SALUS CONTROLS DEVICES

VS10 thermostat can work in **ONLINE** or **OFFLINE** mode.

At first step you need to decide in which mode your thermostat will work.

ONLINE MODE

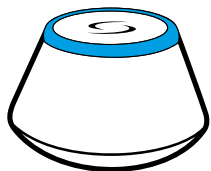

Universal Gateway is CONNECTED TO THE INTERNET

You can configure and use all your devices in the Smart Home App

Download the Smart Home App on your iOS or Android device for remote access to your SALUS equipment.



SALUS Smart Home



OFFLINE MODE

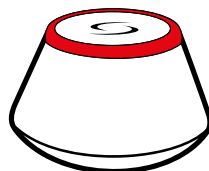

Universal Gateway is NOT CONNECTED TO THE INTERNET

You can use your devices locally without the SmartHome App. Gateway works in this mode as standard ZigBee coordinator.

OR

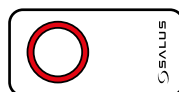

CO10RF Coordinator - You can use standard ZigBee network coordinator to install and use your devices.

Compatible devices:



SR600
Smart Relay



SPE600
Smart Plug



KL08RF wireless wiring centre for 8-zone underfloor heating.



KL04RF extension



TRV
(Thermostatic Radiator Valve) with wireless communication.



RX10RF
receiver

Only with Online Mode

Other SmartHome devices/accessories



Window/door Sensor
SW600 or **OS600**



Smoke detector
SD600



Double/single OneTouch button
SB600/CSB600



Water leak sensor
WLS600



RS600
Roller shutter



RE600
ZigBee network signal repeater
(only with UGE600)



RE10RF
ZigBee network signal repeater

4. Before you start (first power up)

4.1 LCD icon description

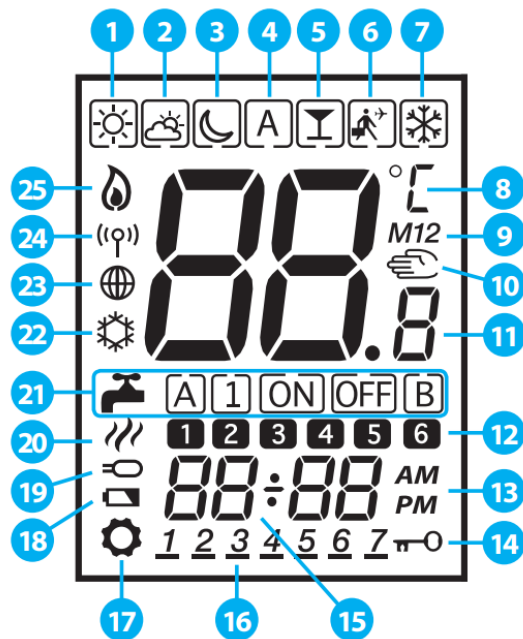

- | | |
|----------------------------------|-----------------------------------|
| 1. Comfort temperature | 13. AM / PM |
| 2. Standard temperature | 14. Lock function |
| 3. Economic temperature | 15. Clock |
| 4. Automatic mode | 16. Day indicator |
| 5. PARTY mode | 17. Settings |
| 6. Holiday mode | 18. Low battery indicator |
| 7. Frost protection mode | 19. External temperature sensor |
| 8. Temperature unit | 20. Hot water heating |
| 9. Group controller | 21. Modes for Hot Water |
| 10. Manual mode / override temp. | 22. Cooling mode ON |
| 11. Current / set temperature | 23. Internet connection indicator |
| 12. Program number | 24. Gateway wireless connection |
| | 25. Heating mode ON |

4.2 Button description

Button Description	
Button	Function
	1. Increase or decrease setpoint temperature. 2. Increase or decrease Day, Clock, Timer, Party, Holiday and Boost. 3. Select installer parameter value.
	1. Mode selection. 2. Moving between parameters.
	1. OK key: Short press to confirm selection. 2. Long press to save and exit. 3. Long press to enter the user settings.
	Hold down these buttons to lock or unlock the keyboard.
	Hold down these buttons to enter installer parameter settings.

4.3 First power up sequence, language choice and preparing to the pair process

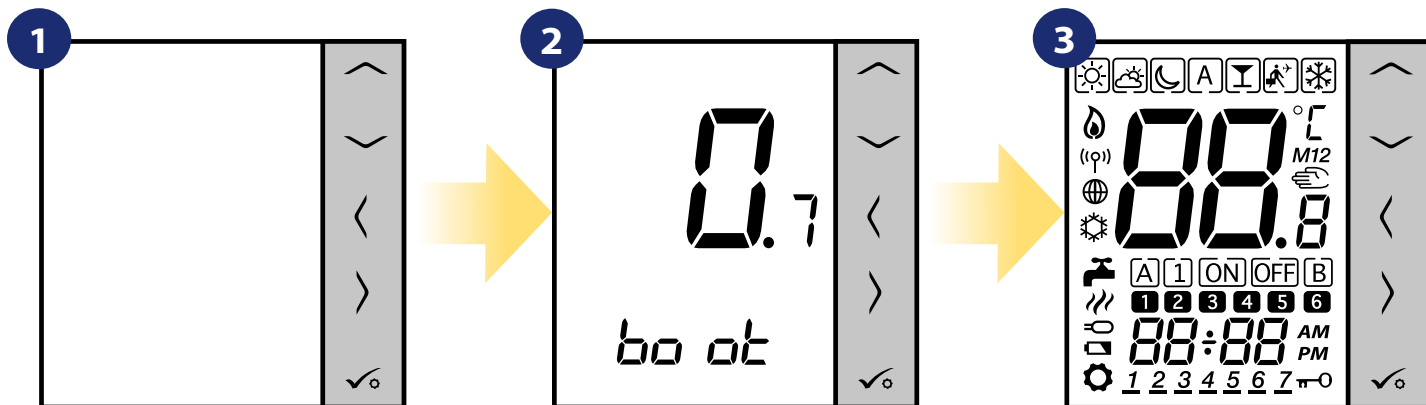



To power on the thermostat you have to connect it to the 230V power supply then...

After that, thermostat will automatically power up and start boot sequence...

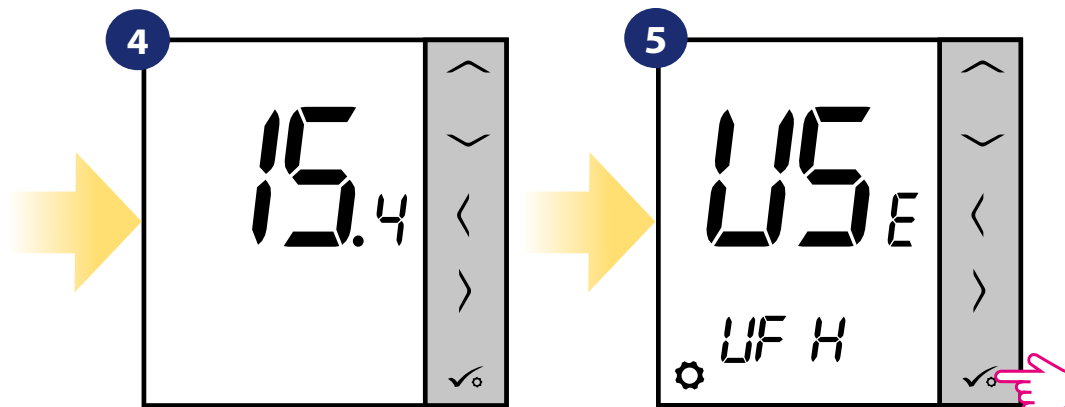
...it will display all icons...



...then thermostat will display the software version.

Set your thermostat for underfloor heating or radiator heating by „” or „” buttons. Then confirm by  button.

5. Installation by SALUS Smart Home application (ONLINE MODE)

5.1 General informations about SALUS Smart Home application

Thanks to UGE600 Universal Gateway and SALUS Smart Home app system allows you to remote control of your heating system in any place you are in the moment by smartphone, tablet or computer with Internet connection. Then you have also access to advanced functions of VS10WRF/VS10BRF thermostat. You can also create OneTouch rules to customize system to your needs.

- 1 First make sure that you have downloaded the Salus Smart Home App from the Google Play or App Store. You will need to follow a few easy steps to create an account and then link your thermostat to the Universal Gateway and to the App.

You can also access the web version on:
<http://eu.salusconnect.io/>



2



To begin the pairing process the Gateway should be plugged into the power supply and connected to the Internet. Also, make sure that the UGE600 is added to your Salus Smart Home App. For the installation of the Universal Gateway, please refer to the UGE600 manual on salus-manuals.com

3



Make sure that your UGE600 Universal Gateway is added to the App. The LED of the Gateway should be steady blue. Then go to VS10WRF/VS10BRF thermostat and begin pairing process with the UGE600 and add it to the App.

5.2 Configuration as a programmable thermostat

5.2.1 Pairing with underfloor heating wiring centre (KL08RF/Control Box)



Please note:

For easier installation, please make sure you have already added underfloor heating wiring centre (KL08RF/Control Box) to your ZigBee network (please refer to the underfloor heating wiring centre manual instruction).

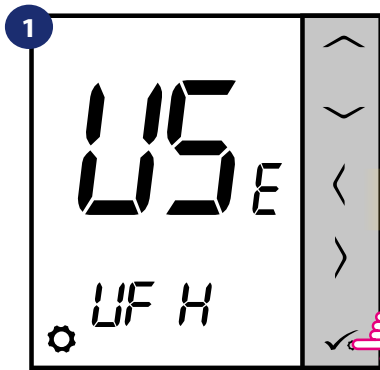

1 Set your thermostat for underfloor heating by „” or „” buttons. Then confirm by button.

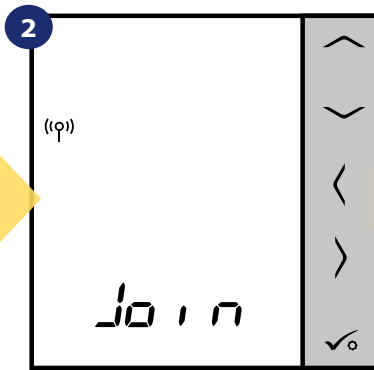

2 Now thermostat is looking for the signal from the coordinator...



3 Go to SALUS Smart Home app.

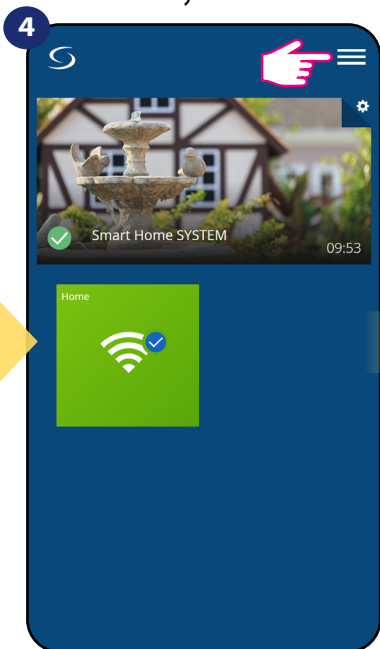

4 Open main menu.

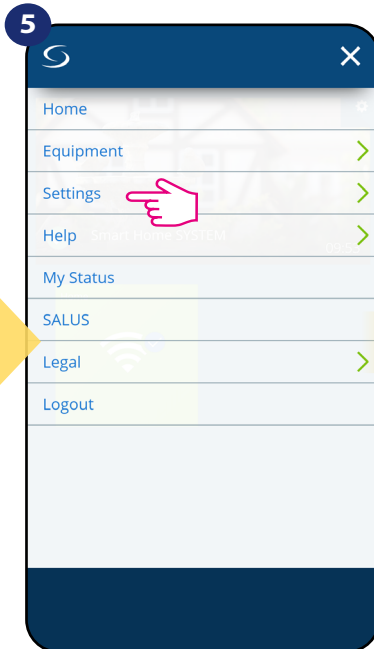

5 Select „Settings”.

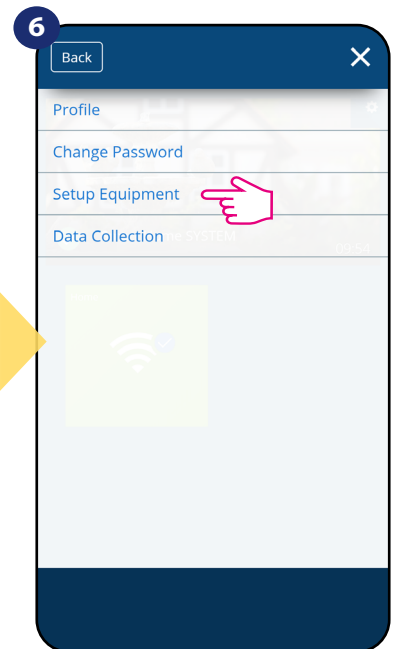

6 Now enter to the „Setup Equipment”.

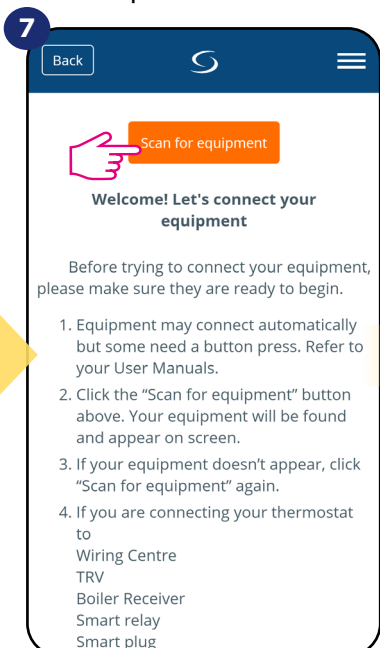

7 Press „Scan for equipment” button.

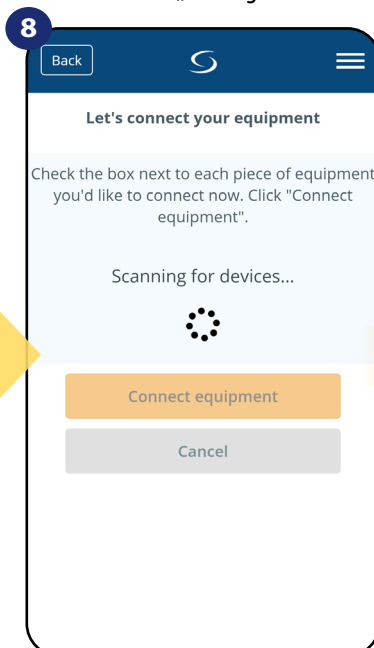

8 App has started scanning...

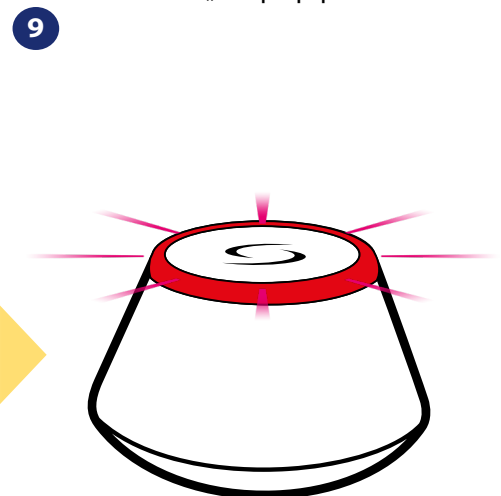

9 ...Gateway has started flashing red and searching for the thermostat...

10

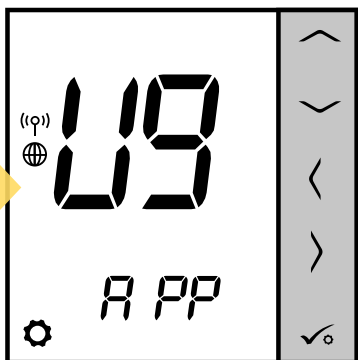

Thermostat is connected. Go to the Smart Home app to configure it.

11

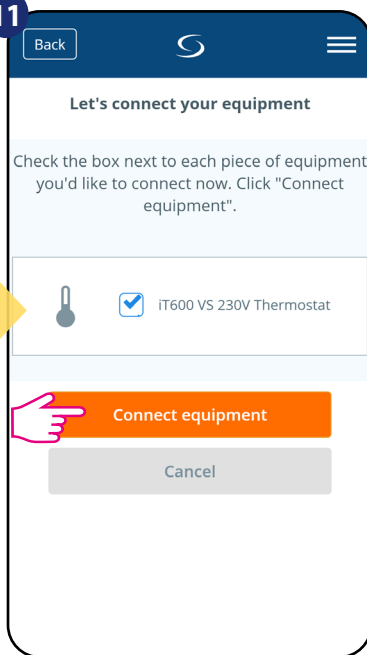

Select your thermostat and press „Connect equipment” button.

12

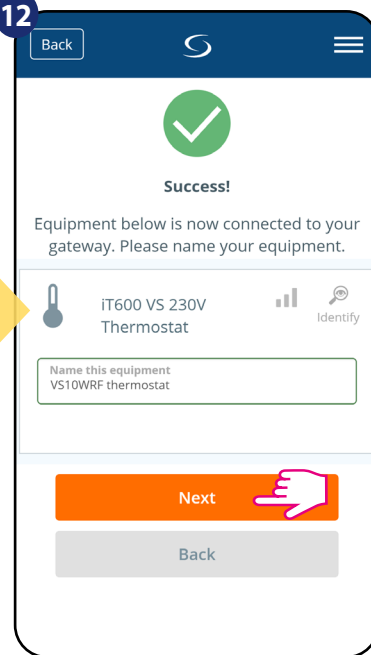

Name your thermostat and go „Next”...

13

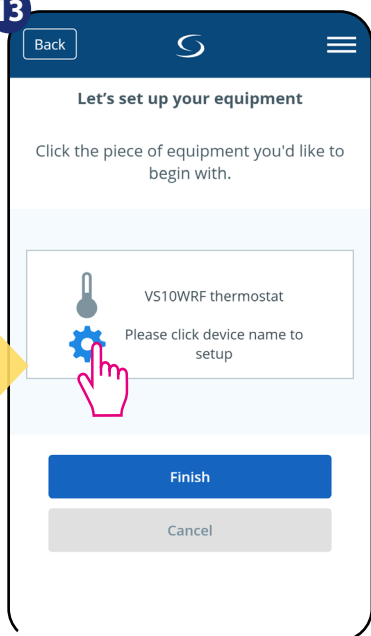

Press gear icon.

14

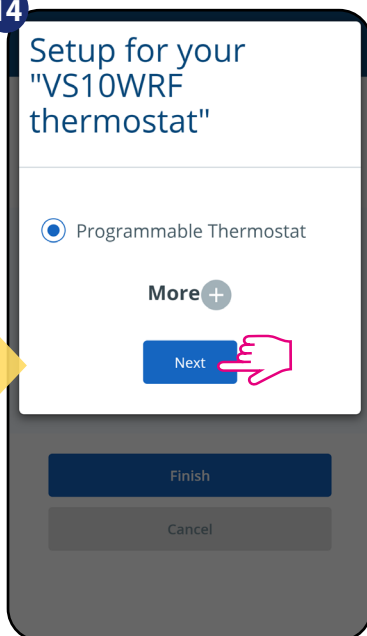

Select option „Programmable Thermostat”.

15

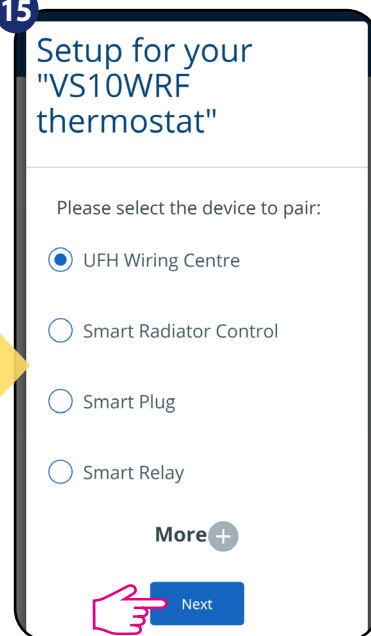

Now choose „UFH Wiring Centre” option.

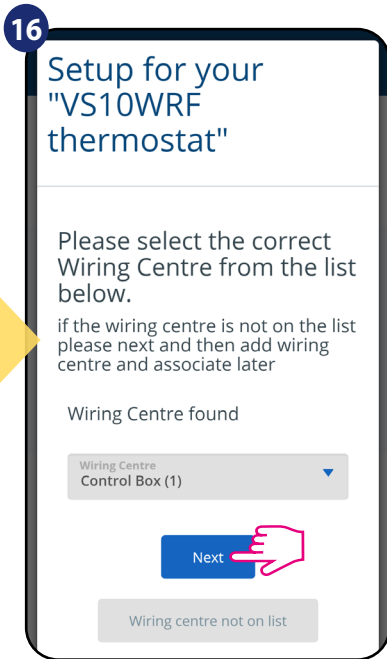

Select your KL08RF/Control Box added before.

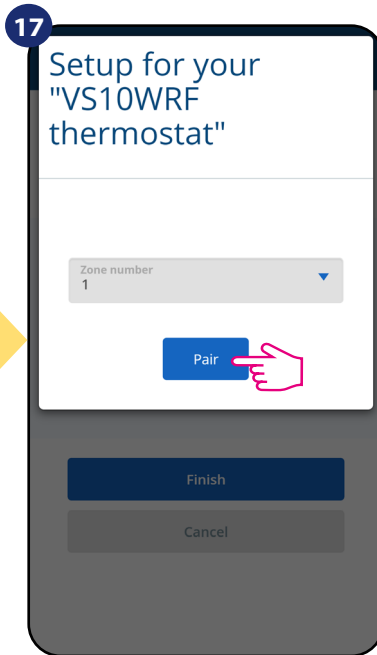

Select the zone which you want attribute to your thermostat.

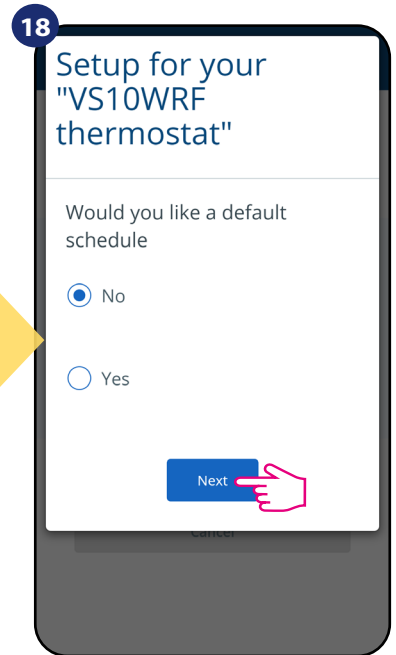

Choose „No” if you want to set your own schedule later or „Yes” if default now.

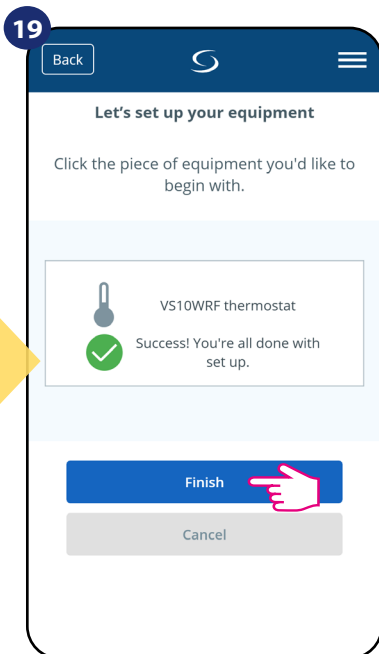

Press „Finish” button to end the set up process in the app.

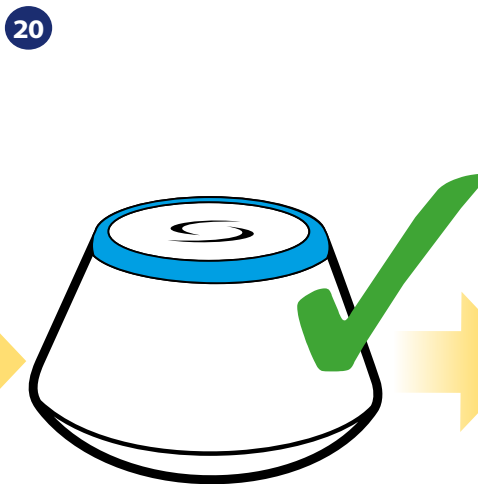

Gateway stop flashing and turn to steady blue color which means pair process has been finished.

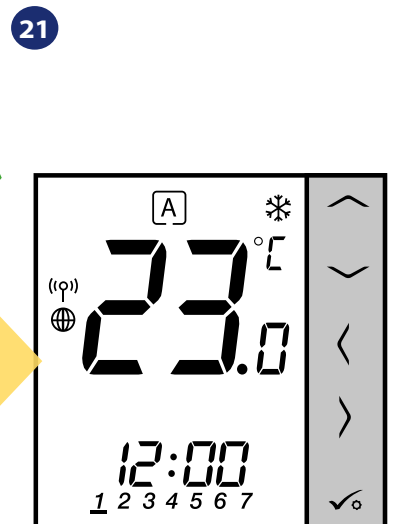

After that thermostat will display main screen. You successfully configured VS10WRF/VS10BRF thermostat with KL08RF Control Box.



5.2.2 Pairing with wireless TRV radiator head

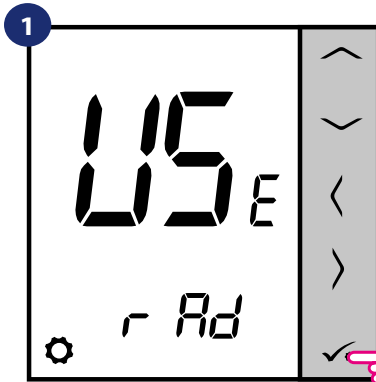

Please note:

For easier installation, please make sure you have already added wireless TRV radiator heads to your ZigBee network (please refer to the wireless TRV radiator head manual instruction).



Set your thermostat for radiators by „” or „” buttons. Then confirm by  button.

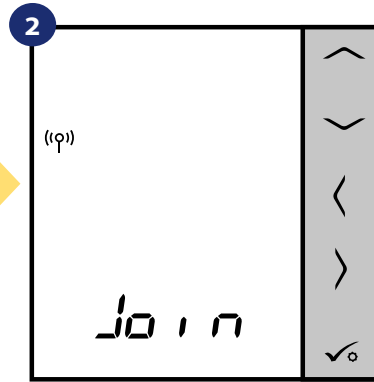

Now thermostat is looking for the signal from the coordinator...



Go to SALUS Smart Home app.

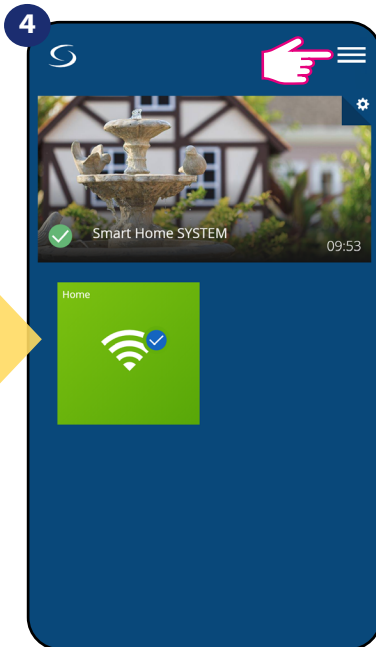

Open main menu.

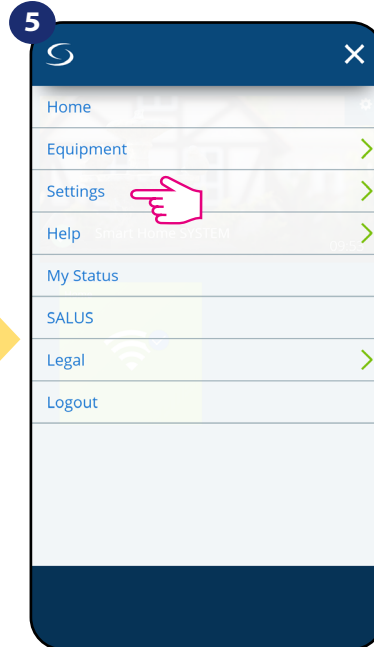

Select „Settings”.

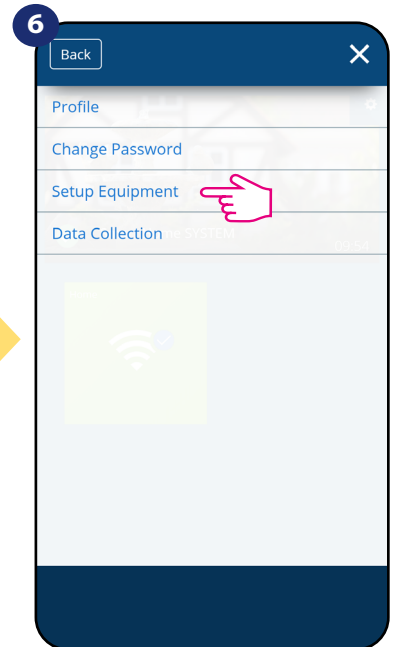

Now enter to the „Setup Equipment”.

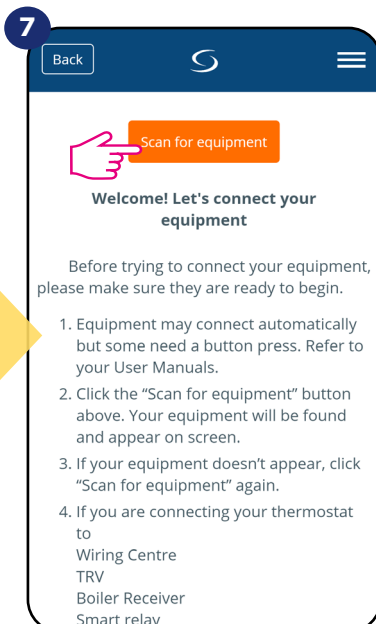

Press „Scan for equipment” button.

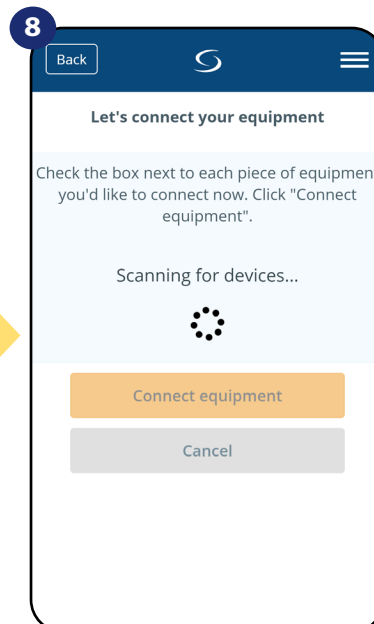

App has started scanning...

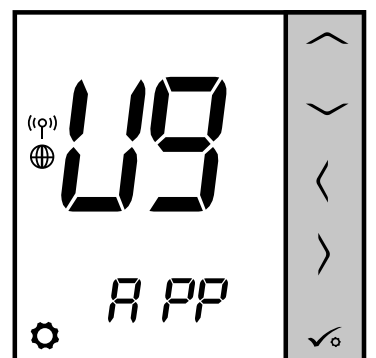
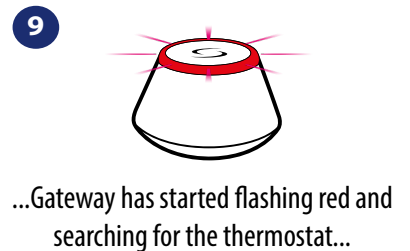

Thermostat is connected. Go to the Smart Home app to configure it. 15

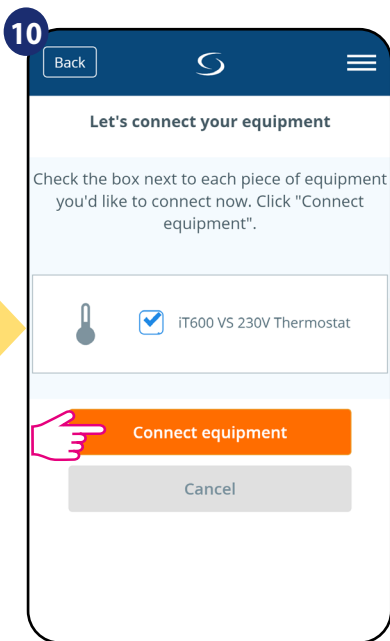

Select your thermostat and press „Connect equipment” button.

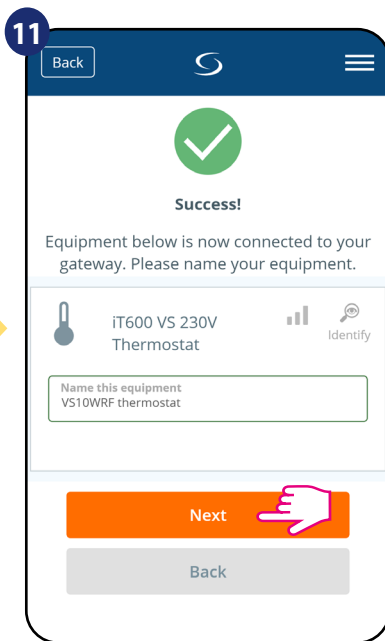

Name your thermostat and go „Next”...

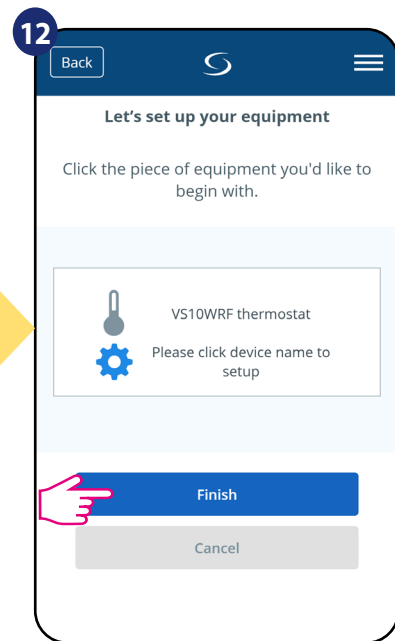

Press gear icon.

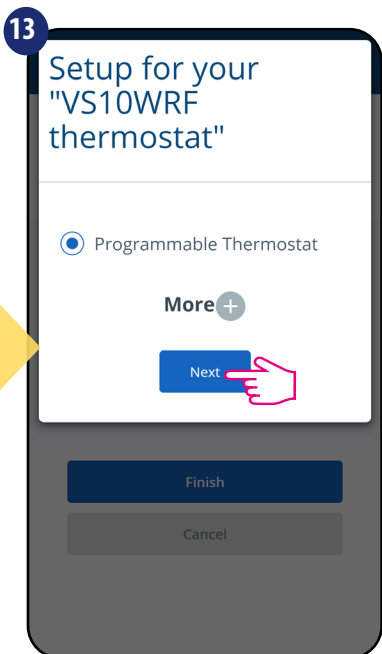

Select option „Programmable Thermostat”.

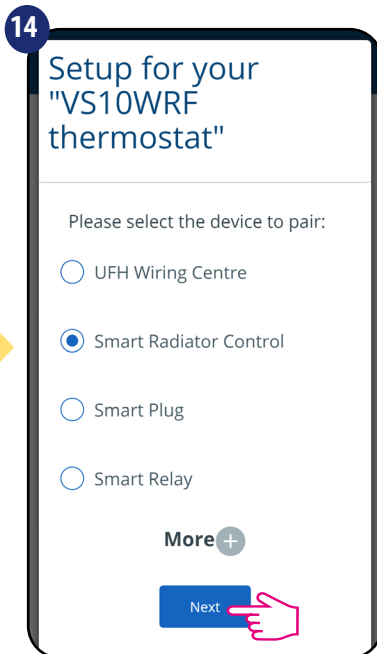

Now choose Smart Radiator Control.

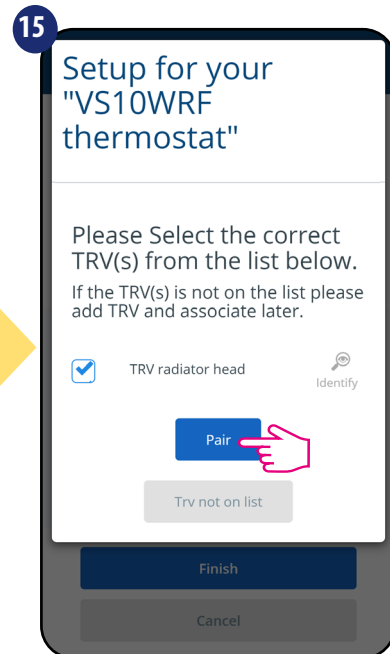

Select your TRV radiator head from the list.

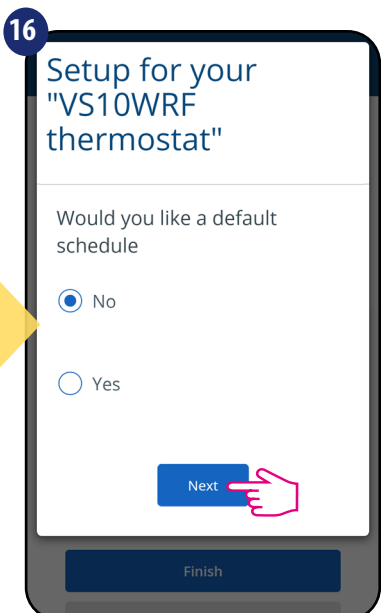

Choose „No” if you want to set your own schedule later or „Yes” if default now.

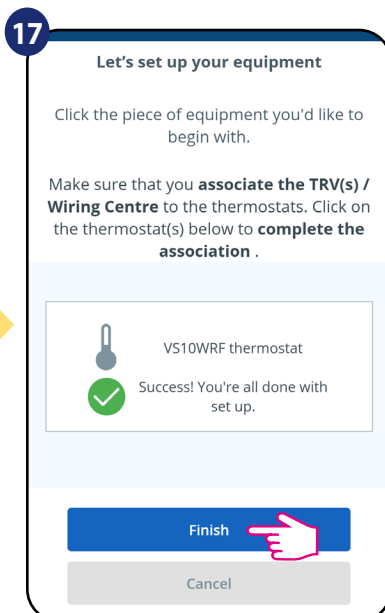

Press „Finish” button to end the set up process in the app.

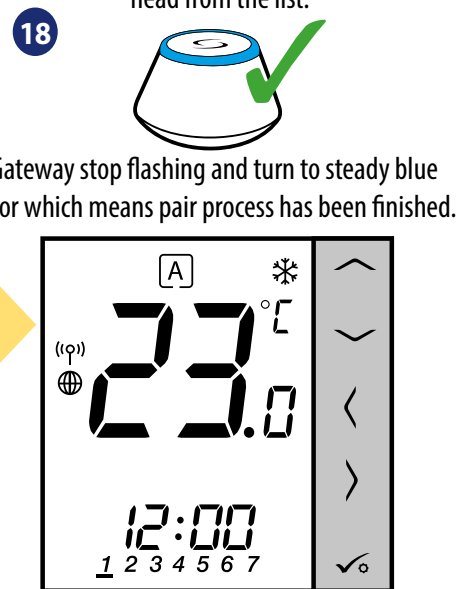

Gateway stop flashing and turn to steady blue color which means pair process has been finished.

After that thermostat will display main screen. You successfully configured VS10WRF/VS10BRF thermostat with Wireless TRV radiator head.

5.2.3 Pairing with Smart Plug SPE600



Please note:

For easier installation, please make sure you have already added Smart Plug SPE600 to your ZigBee network (please refer to the Smart Plug SPE600 manual instruction).

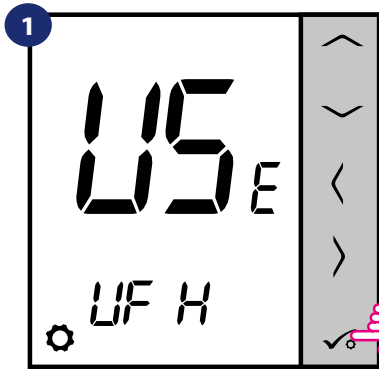

1 Set your thermostat for underfloor heating by „” or „” buttons. Then confirm by button.

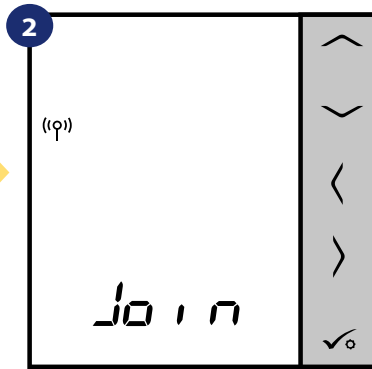

2 Now thermostat is looking for the signal from the coordinator...



3 Go to SALUS Smart Home app.

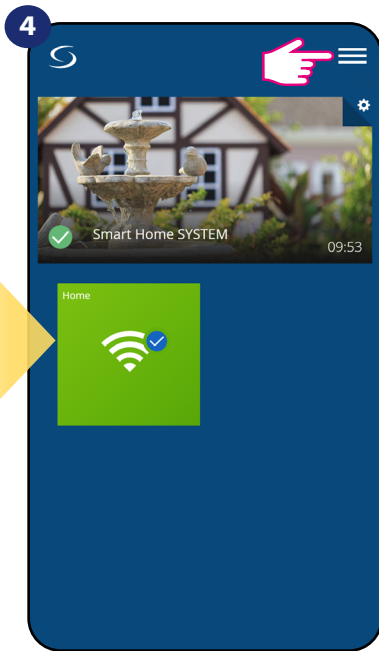

4 Open main menu.

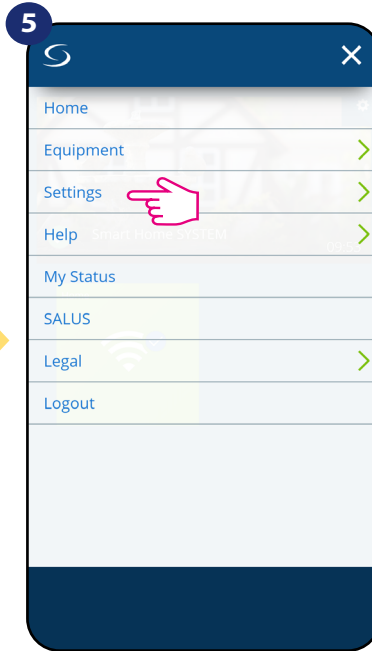

5 Select „Settings”.

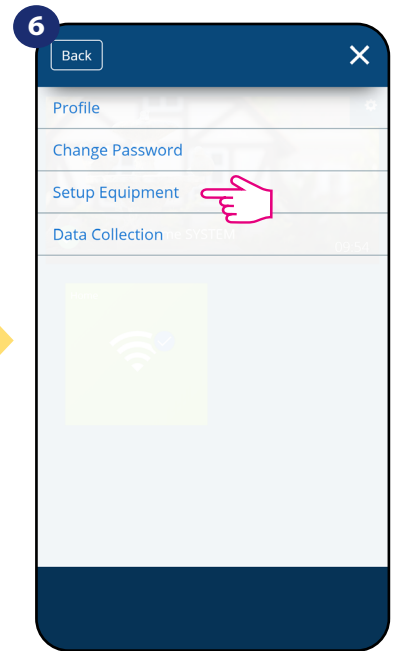

6 Now enter to the „Setup Equipment”.

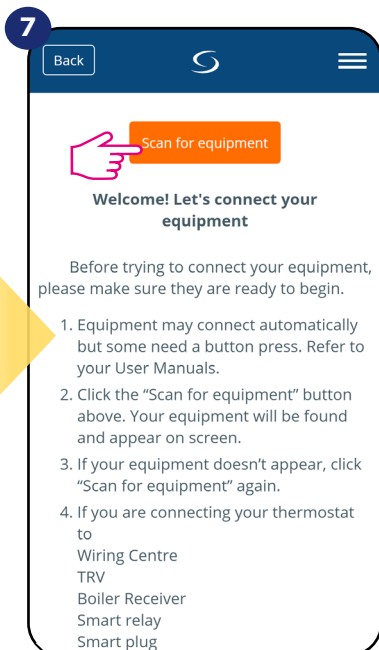

7 Press „Scan for equipment” button.

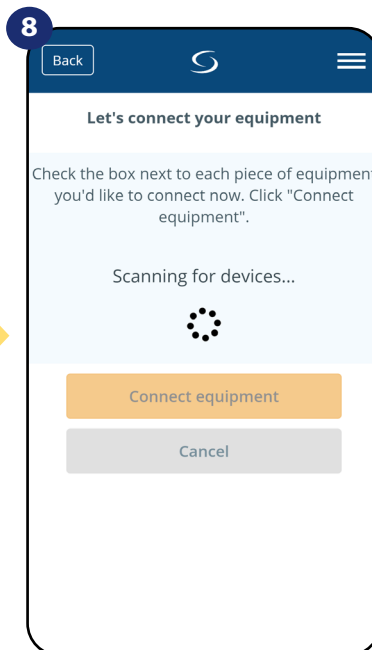

8 App has started scanning...

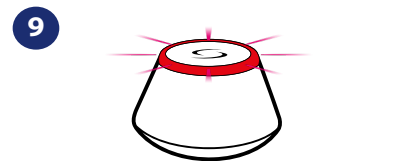

9 ...Gateway has started flashing red and searching for the thermostat...



10 Thermostat is connected. Go to the Smart Home app to configure it.

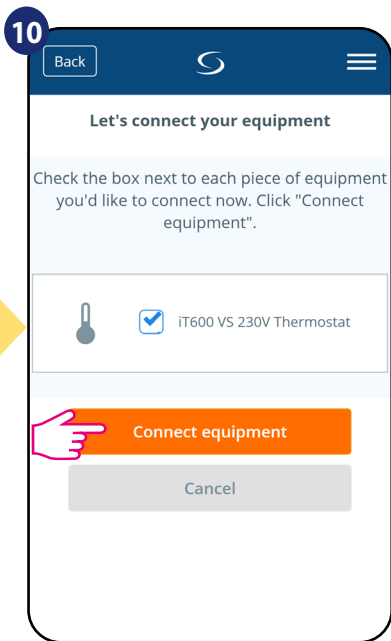

Select your thermostat and press „Connect equipment” button.

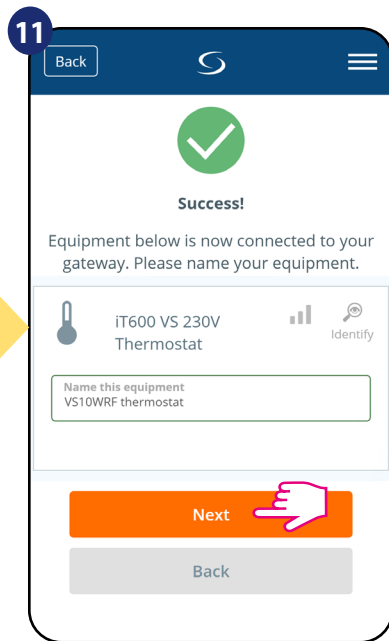

Name your thermostat and go „Next”...

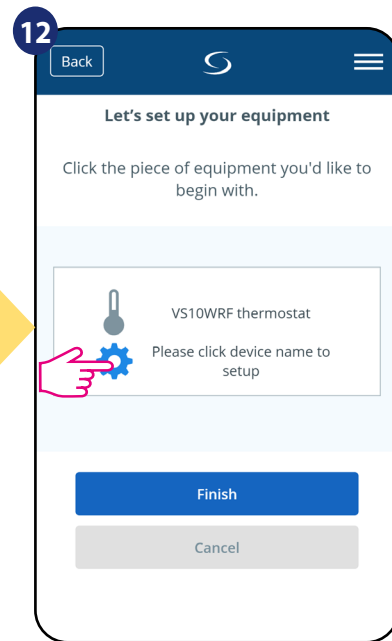

Press gear icon.

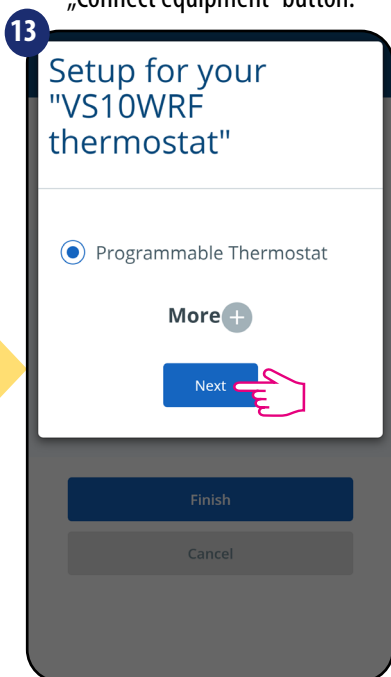

Select option „Programmable Thermostat”.

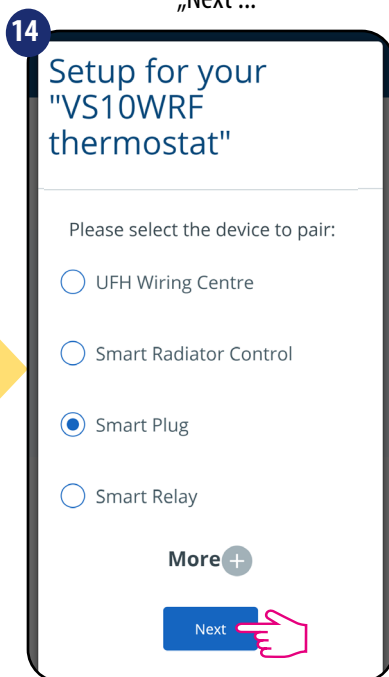

Now choose Smart Plug.

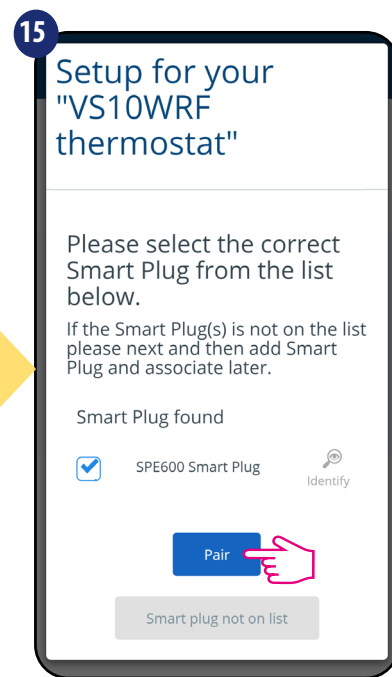

Select your Smart Plug from the list.

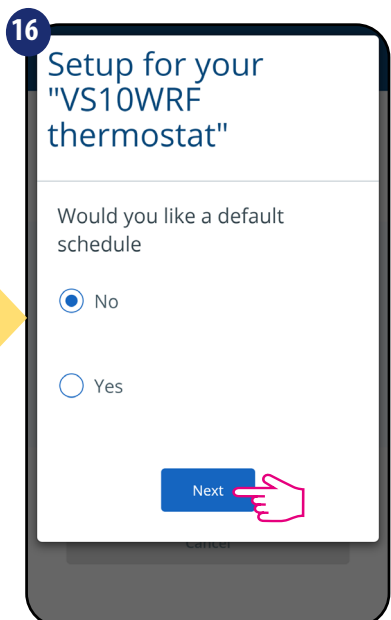

Choose „No” if you want to set your own schedule later or „Yes” if default now.

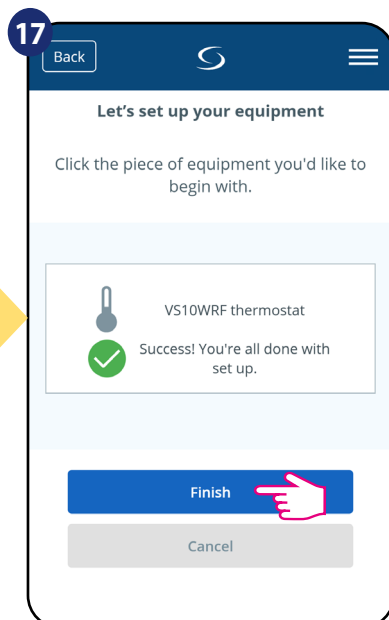

Press „Finish” button to end the set up process in the app.

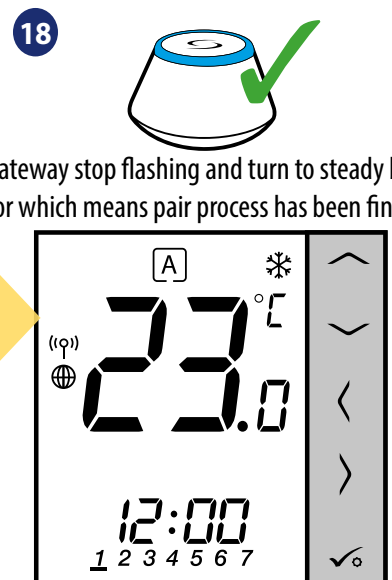

Gateway stop flashing and turn to steady blue color which means pair process has been finished.

After that thermostat will display main screen. You successfully configured VS10WRF/VS10BRF thermostat with Smart Plug SPE600.

5.2.4 Pairing with Smart Relay SR600



Please note:

For easier installation, please make sure you have already added Smart Relay SR600 to your ZigBee network (please refer to the Smart Relay SR600 manual instruction).

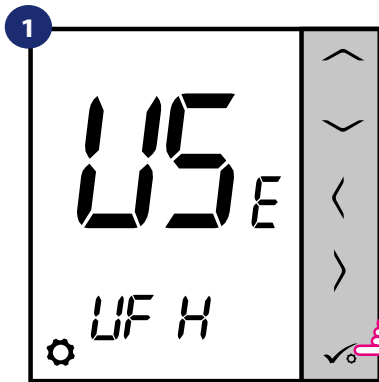

1 Set your thermostat for underfloor heating by „” or „” buttons. Then confirm by button.

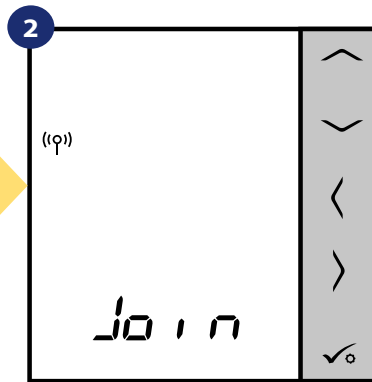

2 Now thermostat is looking for the signal from the coordinator...



3 Go to SALUS Smart Home app.

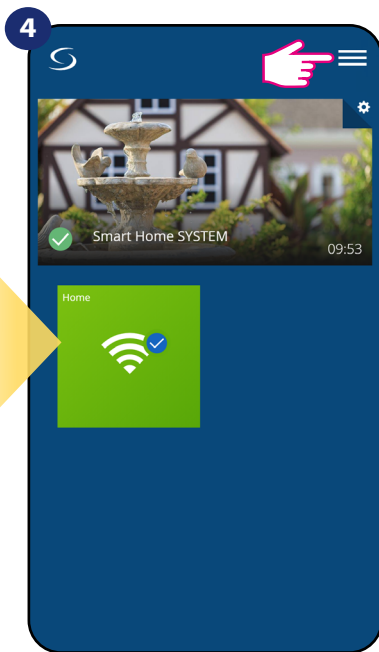

4 Open main menu.

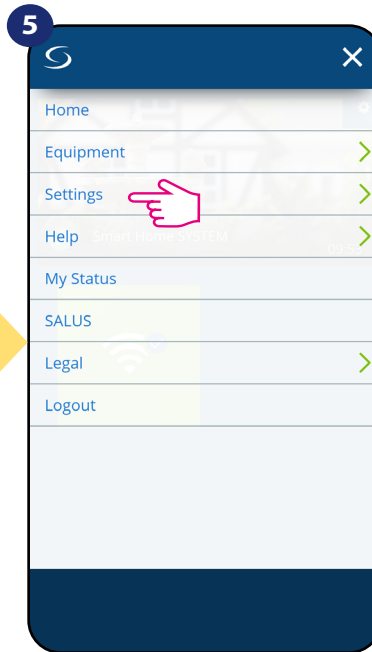

5 Select „Settings”.

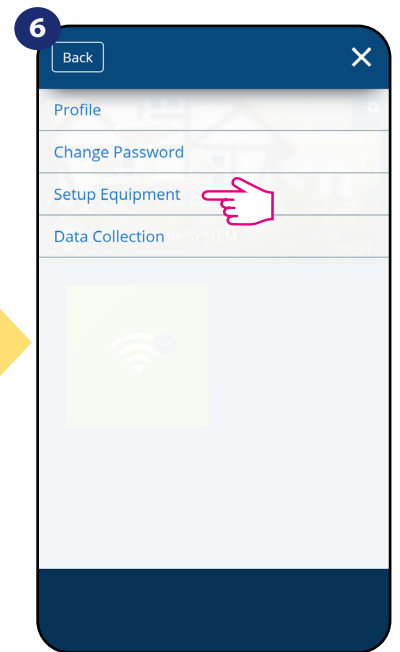

6 Now enter to the „Setup Equipment”.

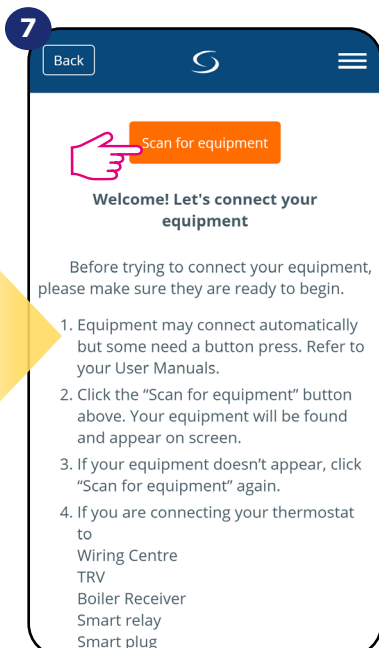

7 Press „Scan for equipment” button.

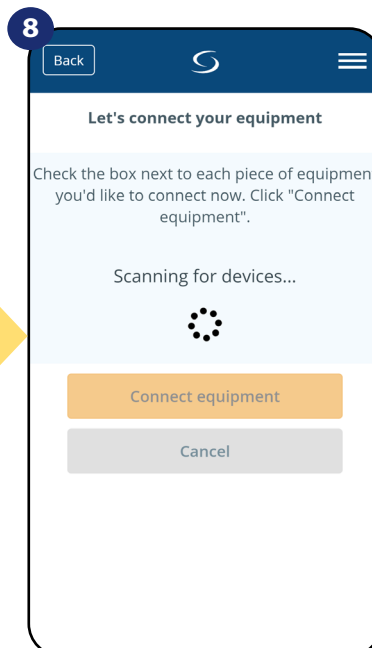

8 App has started scanning...

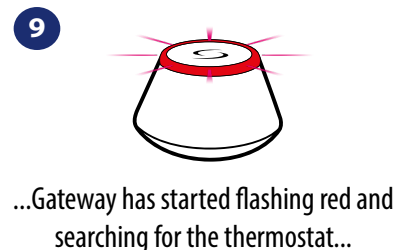

9 ...Gateway has started flashing red and searching for the thermostat...

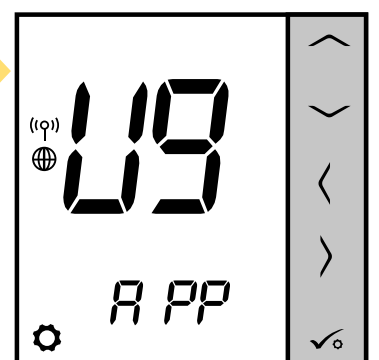

10 Thermostat is connected. Go to the Smart Home app to configure it.

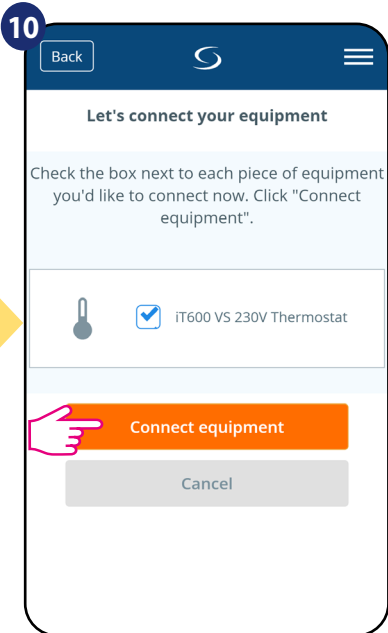

Select your thermostat and press „Connect equipment” button.

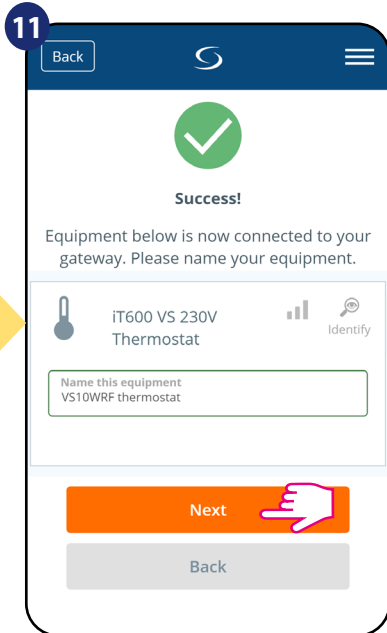

Name your thermostat and go „Next”...

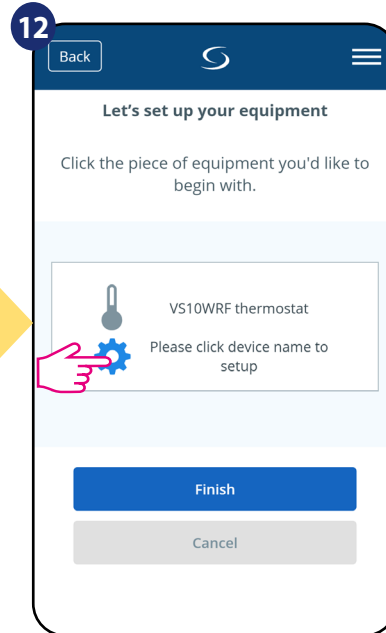

Press gear icon.

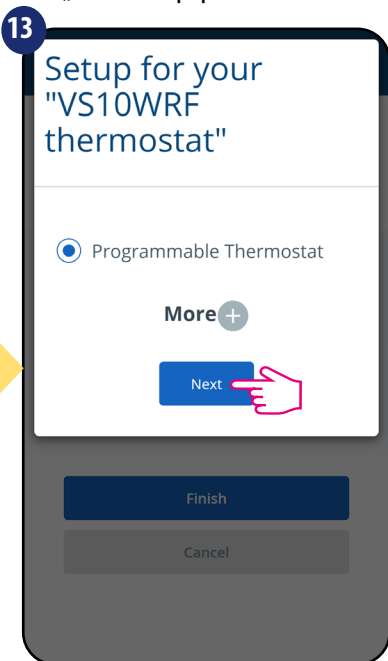

Select option „Programmable Thermostat”.

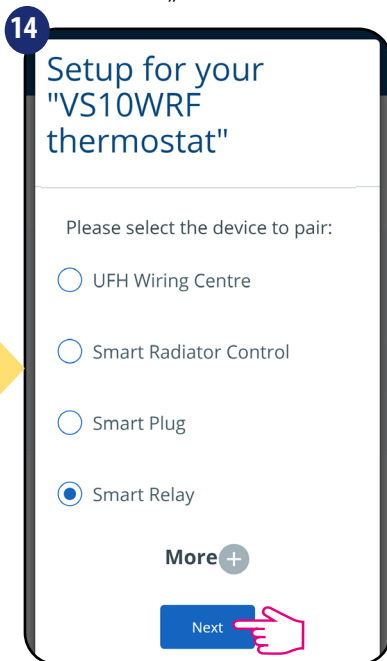

Now choose Smart Relay.

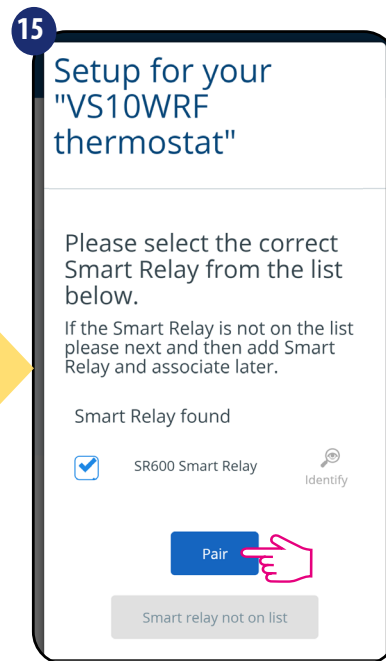

Select your Smart Relay from the list.

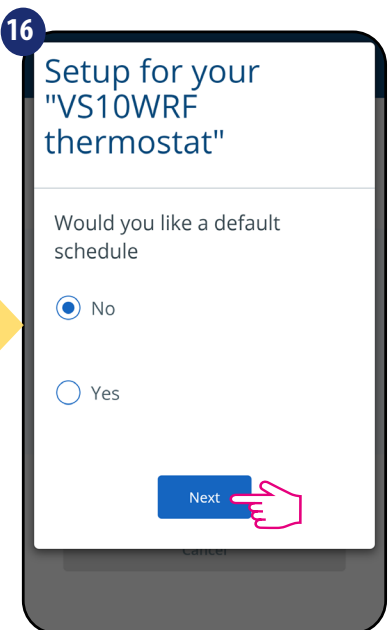

Choose „No” if you want to set your own schedule later or „Yes” if default now.

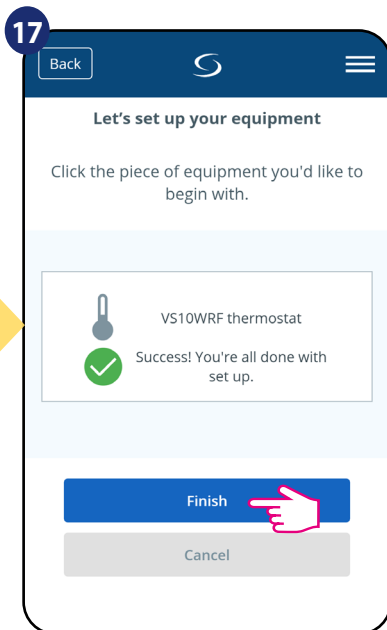

Press „Finish” button to end the set up process in the app.

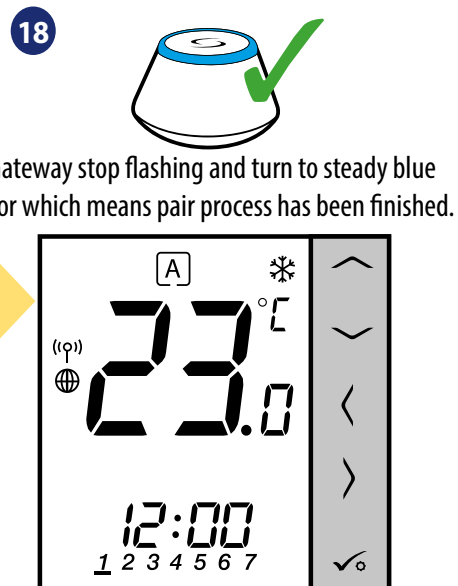

Gateway stop flashing and turn to steady blue color which means pair process has been finished.

After that thermostat will display main screen. You successfully configured VS10WRF/VS10BRF thermostat with Smart Relay SR600.

5.2.5 Pairing with RX10RF receiver



Please note:

For easier installation, please make sure you have already added RX10RF receiver to your ZigBee network (please refer to the RX10RF receiver manual instruction).

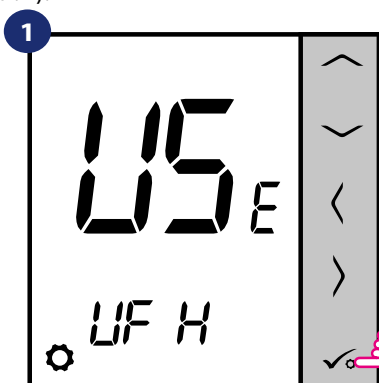

1 Set your thermostat for underfloor heating by „” or „” buttons. Confirm by button.

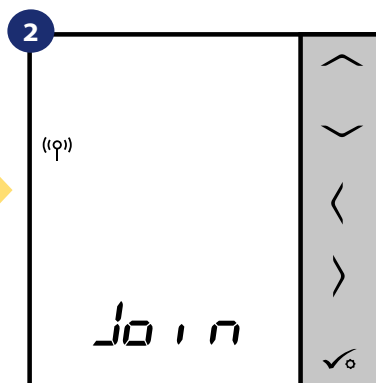

2 Now thermostat is looking for the signal from the coordinator...



3 Go to SALUS Smart Home app

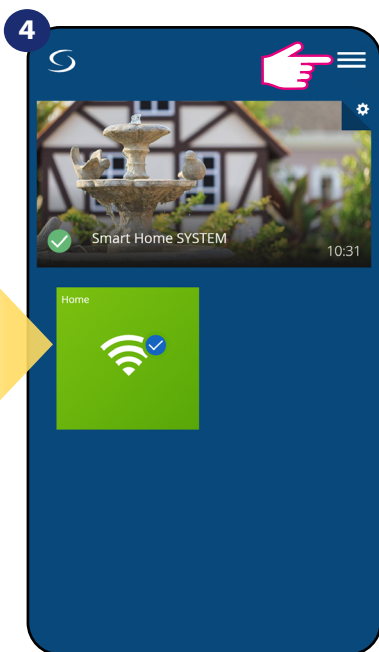

4 Open main menu.

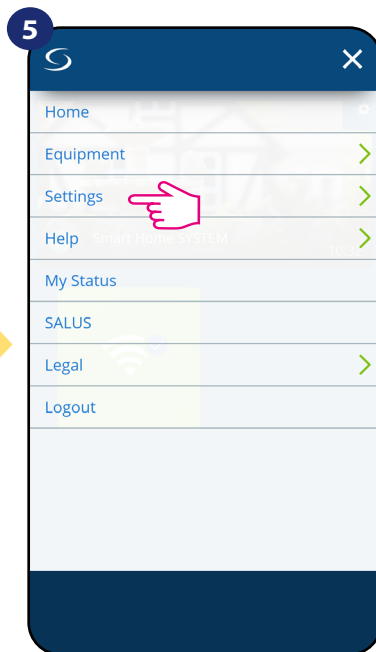

5 Select „Settings”.

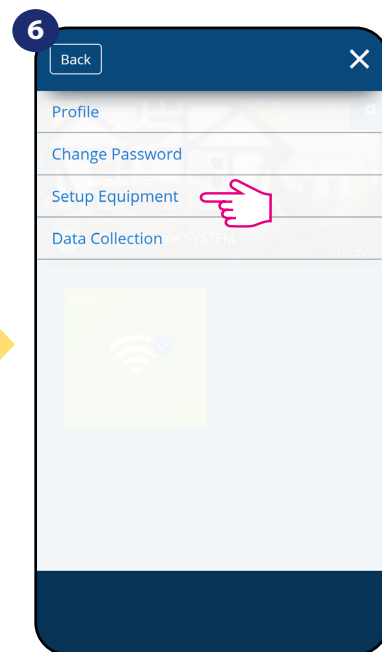

6 Now enter to the „Setup Equipment”.

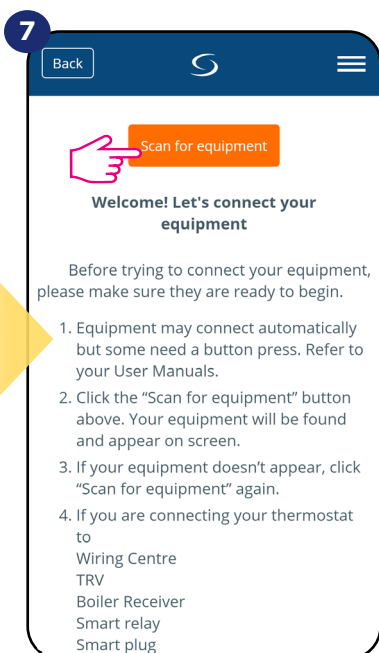

7 Press „Scan for equipment” button.

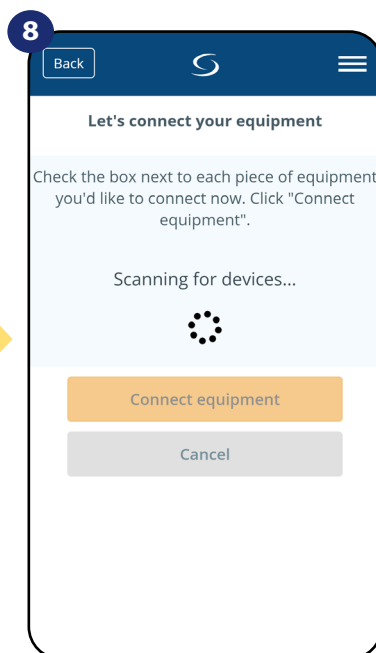

8 App has started scanning...



9 ...Gateway has started flashing red and searching for the thermostat...



10 Thermostat is connected. Go to the Smart Home app to configure it.

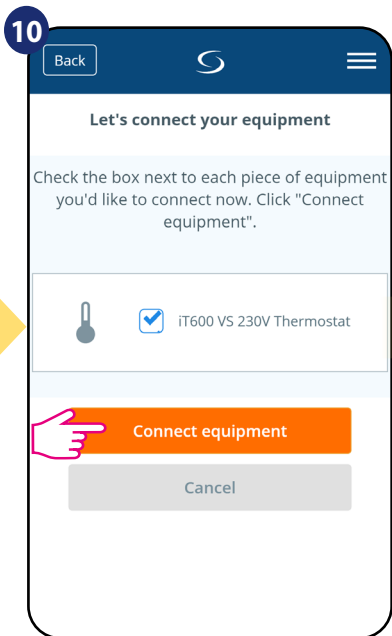

Select your thermostat and press „Connect equipment” button.

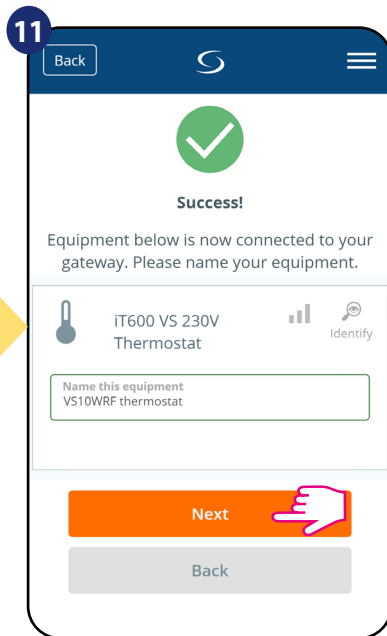

Name your thermostat and go „Next”...

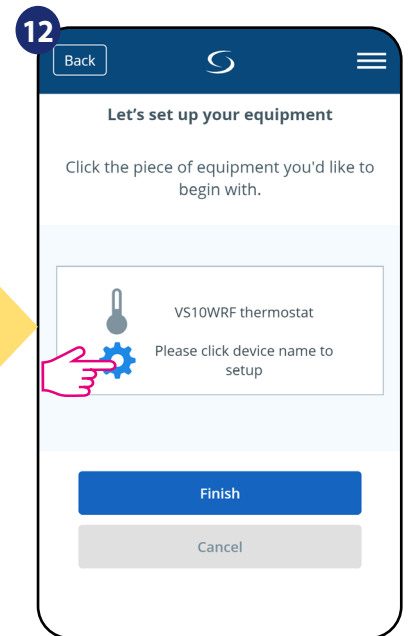

Press gear icon.

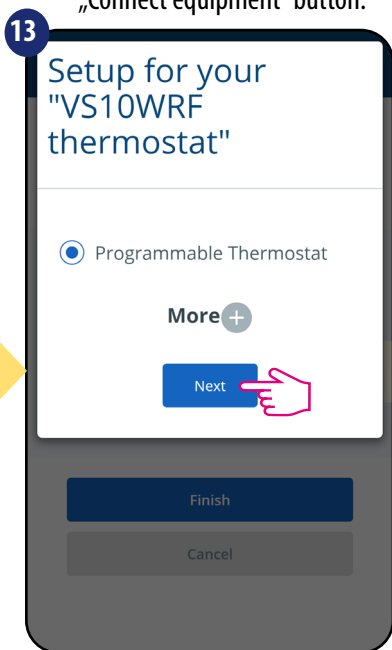

Select option „Programmable Thermostat”.

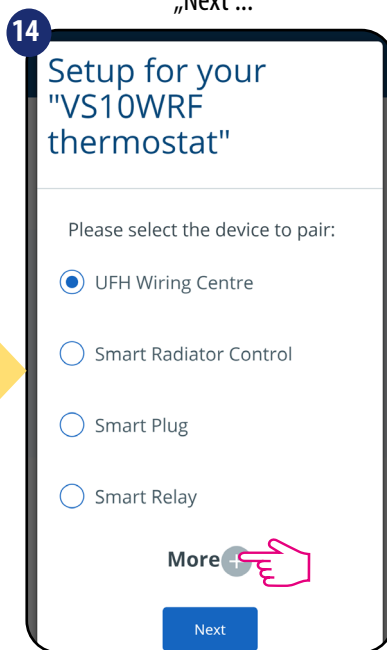

Choose „More” to expand the menu.

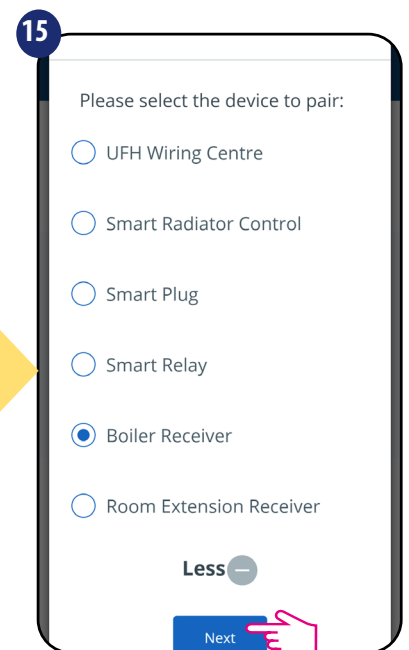

Now choose Boiler Receiver. If RX10RF is set as „RX1” then choose option „Boiler Receiver”. If as a „RX2” then select „Room Extension Receiver”.

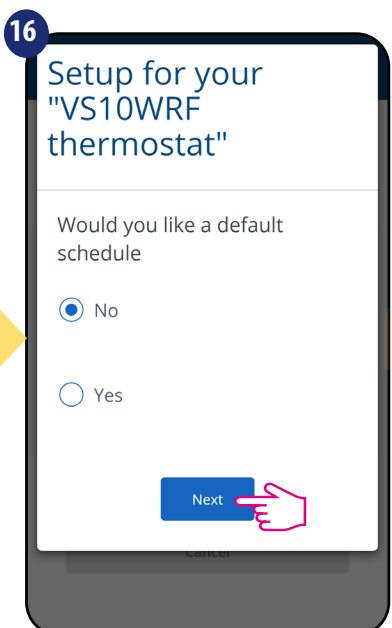

Choose „No” if you want to set your own schedule later or „Yes” if default now.

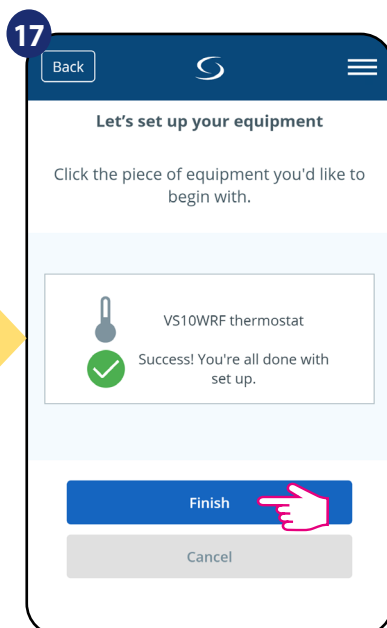

Press „Finish” button to end the set up process in the app.

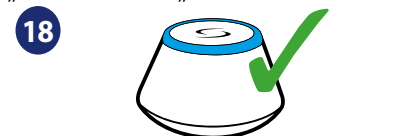

Gateway stop flashing and turn to steady blue color which means pair process has been finished.

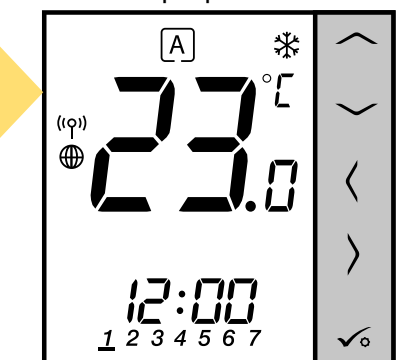

After that thermostat will display main screen. You successfully configured VS10WRF/VS10BRF thermostat with RX10RF receiver.

5.3 Configuration as a hot water timer

5.3.1 Pairing with Room Extension Receiver (RX2)



PLEASE NOTE!

For easier installation, please make sure you have already added other devices to your ZigBee network, such as Underfloor Heating Control Box (KL08RF) or RX10RF.

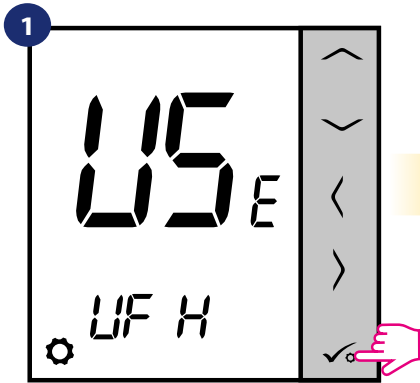

1 Set your thermostat for underfloor heating by „” or „” buttons. Confirm by button.

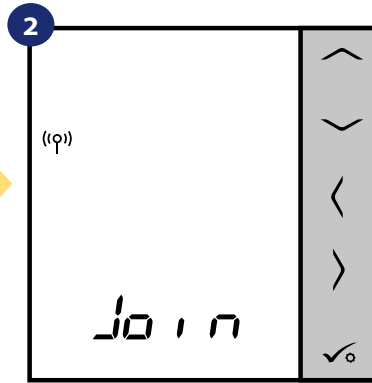

2 Now thermostat is looking for the signal from the coordinator...



3 Go to SALUS Smart Home app.

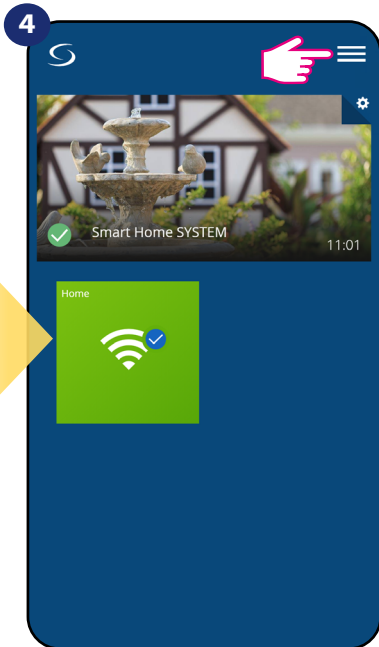

4 Open main menu.

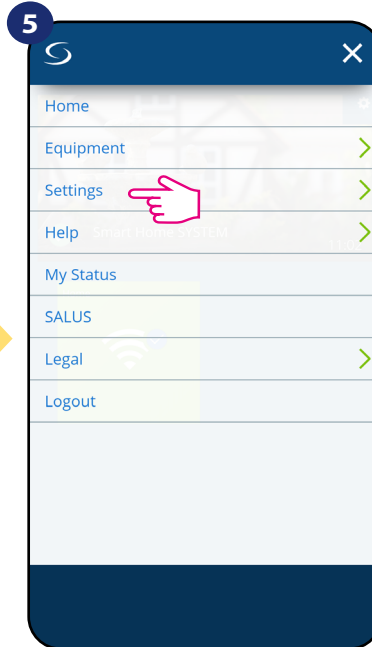

5 Select „Settings”.

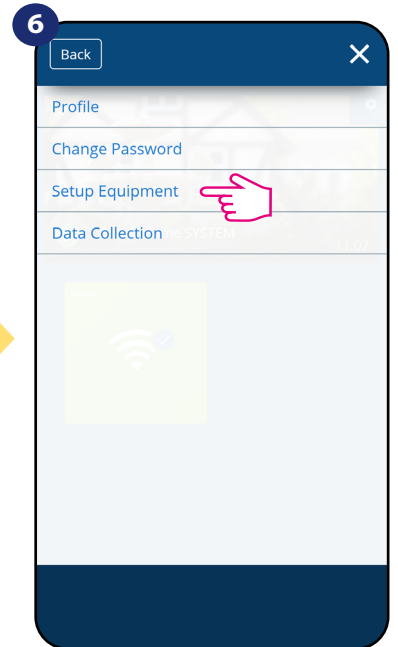

6 Now enter to the „Setup Equipment”.

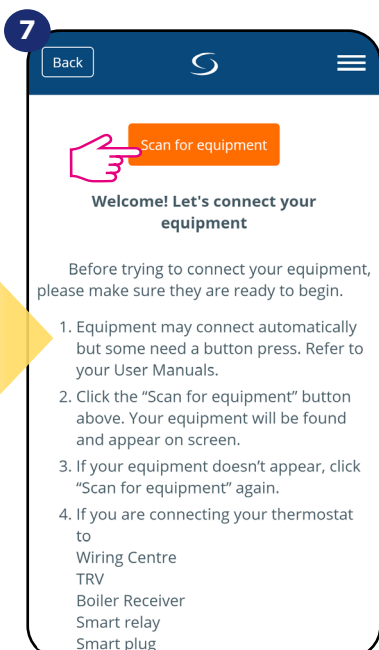

7 Press „Scan for equipment” button.

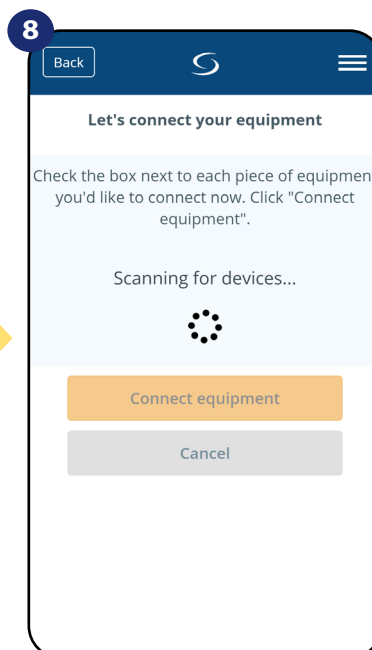

8 App has started scanning...

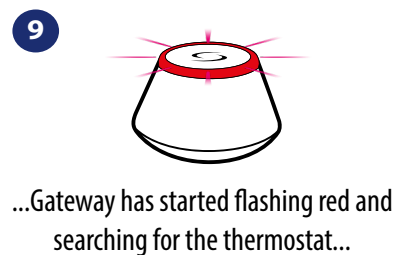

9 ...Gateway has started flashing red and searching for the thermostat...

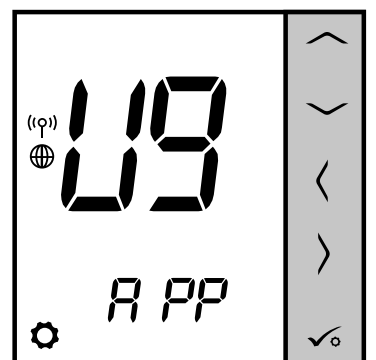

10 Thermostat is connected. Go to the Smart Home app to configure it.

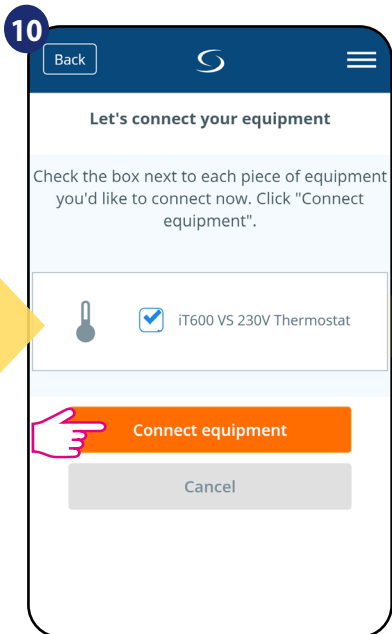

Select your thermostat and press „Connect equipment” button.

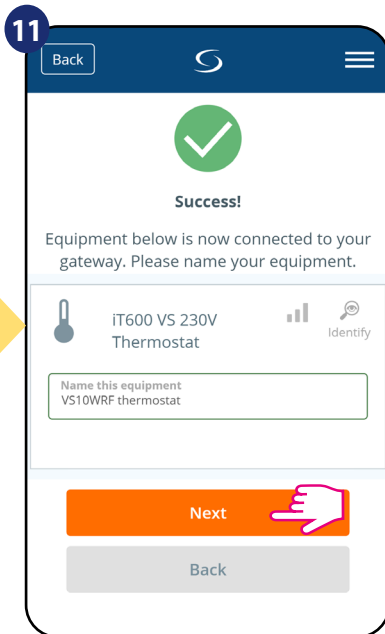

Name your thermostat and go „Next”...

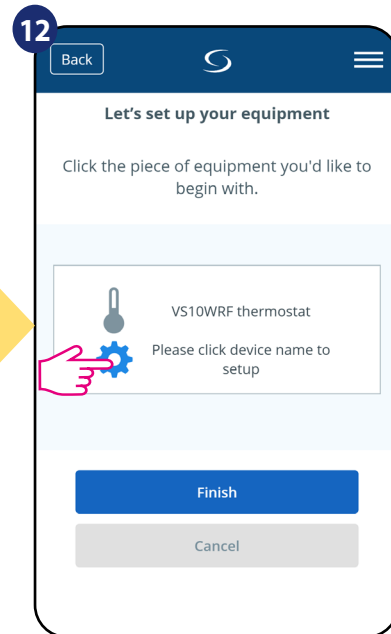

Press gear icon.

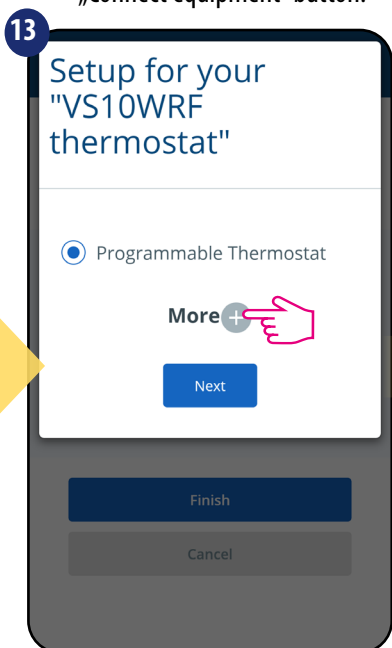

Press „More” to expand the menu.

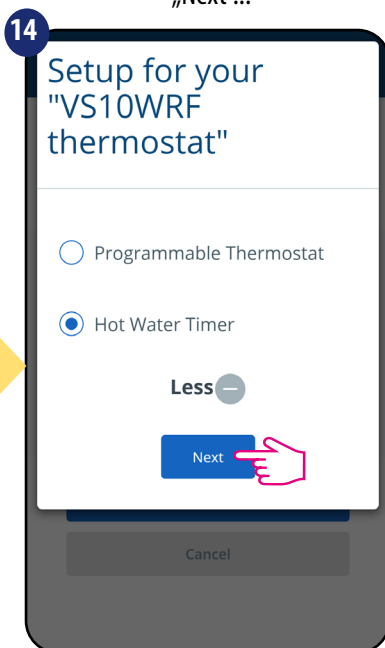

Select option „Hot Water Timer”.

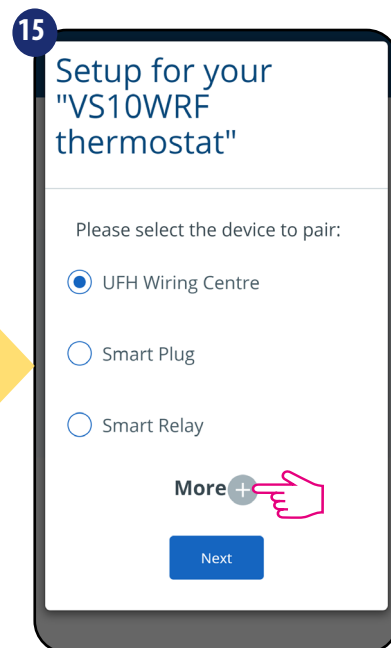

Choose „More” to expand the menu.

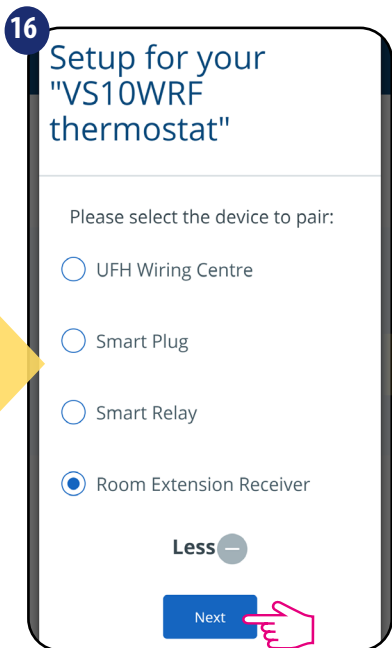

Choose Room Extension Receiver.

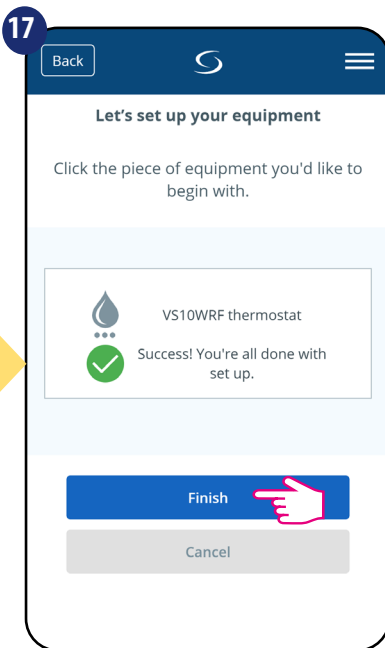

Press „Finish” button to end the set up process in the app.

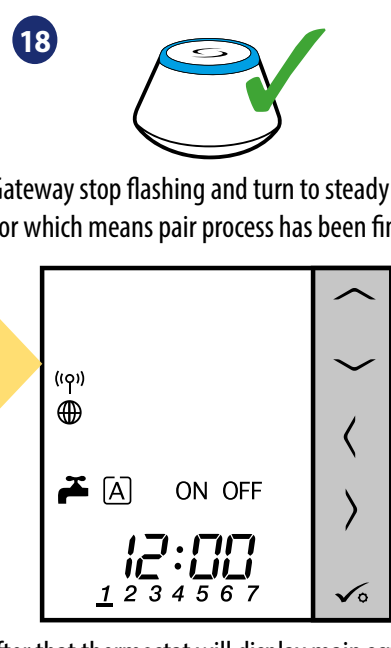

After that thermostat will display main screen. You successfully configured VS10WRF/VS10BRF thermostat as a hot water timer with RX10RF receiver.

6. OPERATING in ONLINE MODE (by app)

6.1 General informations

This section will show how to use your **VS10WRF/VS10BRF thermostat** with the **UGE600 Universal Gateway** and the **Salus Smart Home App**. In order to do that, you will need a **Salus UG600/UGE600 Universal Gateway**, the **Salus Smart Home App** and **Internet connection**. Controlling your thermostat via the App gives you a lot of freedom and the possibilities to manage the temperature in your house/office remotely (Smart Home app is available for Android/iOS mobile devices or Internet browser).

6.2 App icons description

6.2.1 Programmable thermostat

Menu view of VS10WRF/VS10BRF thermostat set as a programmable thermostat in **SALUS SmartHome** application:

The screenshot displays the app's interface for a VS10WRF thermostat. At the top, there is a 'Back' button, a logo, and a menu icon. The main area features a large circular temperature slider with a white knob, showing a setpoint of 21°C and a room temperature of 21.5°C. To the right of the slider is a heat/cool mode indicator with three wavy lines and a hand icon. Below the slider is a 'Thermostat Unlocked' status indicator and a row of icons for identification and settings. At the bottom, there is an 'Information' section showing 'Connected' and 'Online' status, and the model name 'iT600 VS 230V Thermostat'. A mode selection panel on the right shows three options: 'Follow Schedule' (green), 'Permanent Hold' (blue), and 'Off' (yellow).

Thermostat name VS10WRF thermostat

Thermostat name change tool

Setpoint temperature 21°

Setpoint temperature slider

Room temperature 21.5°

Thermostat Heat/Cool mode indicator

Thermostat mode selection

Thermostat locking/unlocking function

Pin/Unpin thermostat to/from main application dashboard

Additional thermostat settings (including advanced installer parameters)

Information

Connected Online

Model iT600 VS 230V Thermostat

Icons of devices like window / door sensors (OS600/SW600), Smart Plug (SPE600) and SR600 smart relay. You can see them only when these devices are paired with system. Through these icons you can pair VS10WRF/VS10BRF thermostat fast with selected device.

6.2.2 Hot Water Timer

Menu view of VS10WRF/VS10BRF thermostat set as a Hot Water Timer in **SALUS SmartHome** application:

Thermostat name

Thermostat name change tool

Hot Water Timer work mode selection tool.

- I - Turned ON
- A - AUTO mode (schedule)
- O - Turned OFF
- B - Temporarily ON mode

Hot Water Timer Unlocked

Thermostat locking/unlocking function

Identification tool

Pin/Unpin thermostat to/from main application dashboard

Additional thermostat settings (including advanced installer parameters)

Information

Connected	Online
Model	iT600 VS Battery Hot Water Timer

Icons of devices like window / door sensors (OS600/SW600), Smart Plug (SPE600) and SR600 smart relay. You can see them only when these devices are paired with system. Through these icons you can pair VS10WRF/VS10BRF thermostat fast with selected device.

6.3 Change thermostat name (pencil icon)

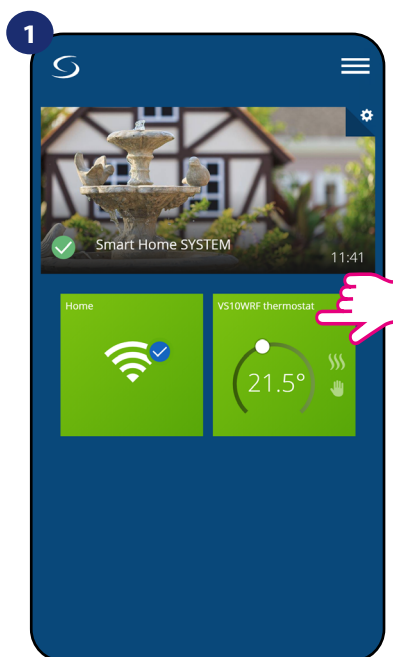

Select the thermostat in the main app menu.

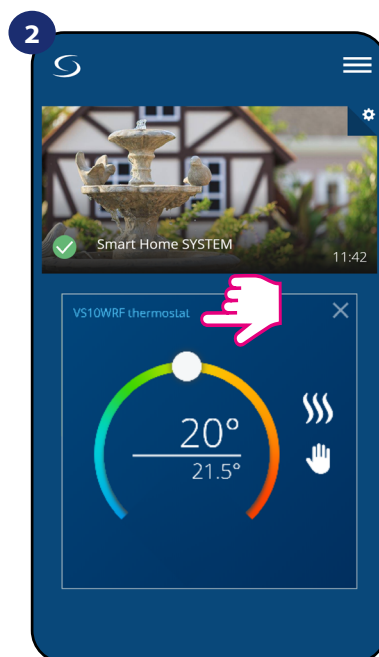

Press the thermostat's name.

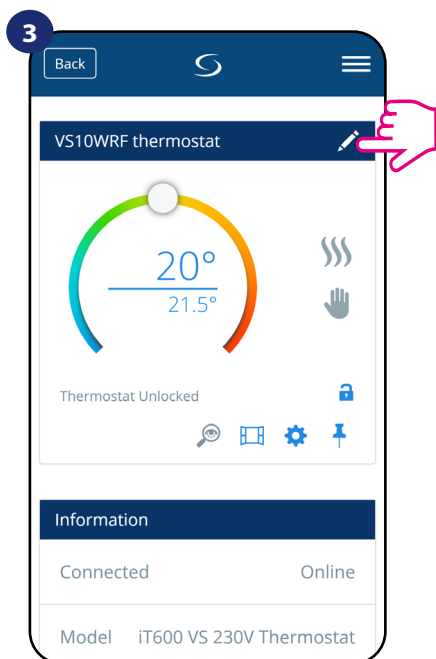

Click on the pencil icon.

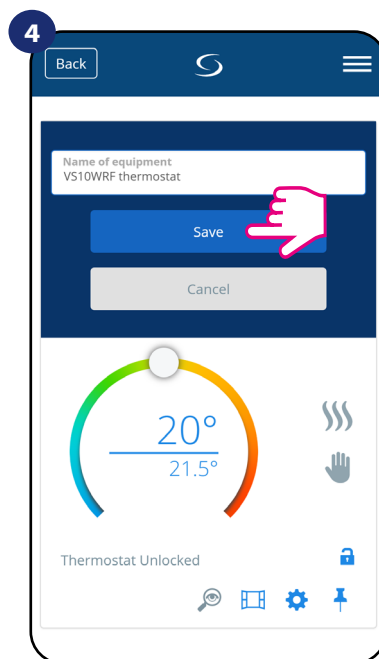

Name your thermostat and confirm it by „Save” button.

6.4 Work as a programmable thermostat

6.4.1 Setpoint temperature change

You can change the setpoint by sliding the cursor to left/right on your App. On your App screen, the setpoint temperature is the number displayed in a larger font.

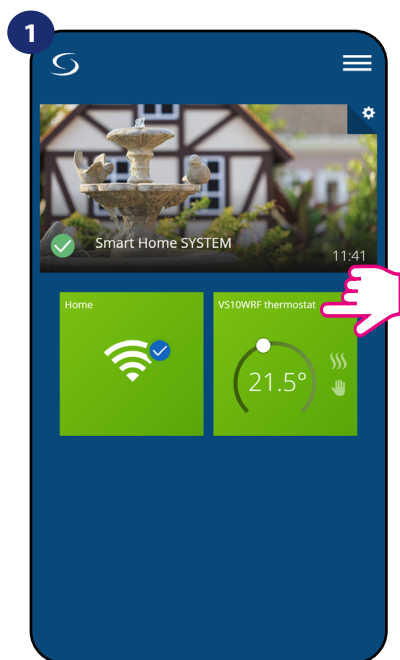

Select the thermostat in the main app menu.

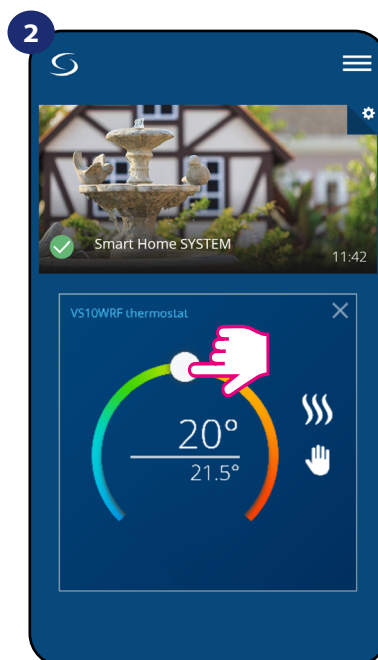

Old setpoint value.

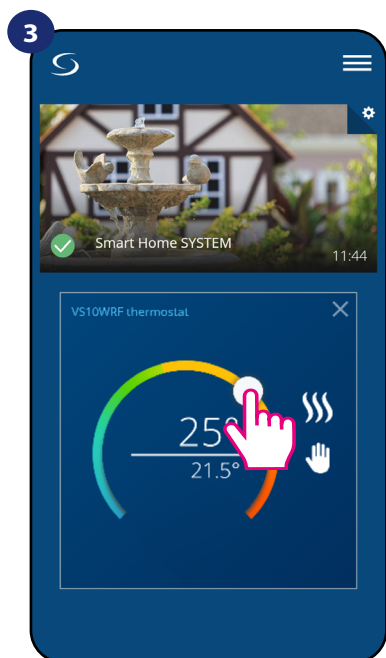

New setpoint value.

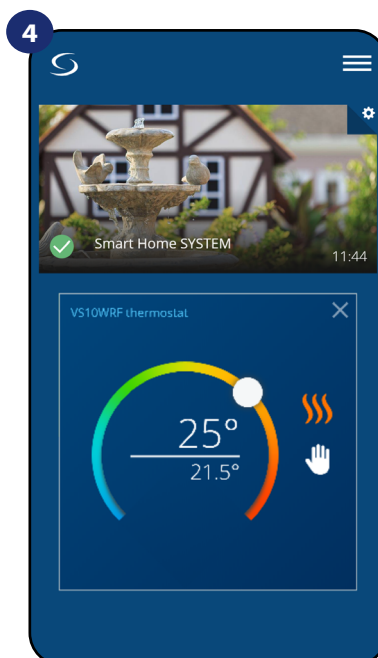

Thermostat has started heating (flame icon changed colour from white to orange).

6.4.2 Heat/Cool mode change (KL08RF connection)

VS10WRF/VS10BRF thermostat could be a heating device or cooling device. **Default thermostat is set for heating.** To set cool mode you have to insert the jumper into „CO” terminal on KL08RF side. Look at the instructions below:

HEATING MODE:



When there is no jumper at „CO” terminal KL08RF is automatically working in heating mode.

In the application you will see orange thermostat tile with „Flame” icon when heating mode is on.

When thermostat is calling for heating then flame icon is displayed.

COOLING MODE:



When there is jumper at „CO” terminal KL08RF is automatically working in cooling mode.

In the application you will see blue thermostat tile with „snowflake” icon when cooling mode is on.

On the thermostat display you will see „snowflake” icon.

6.4.3 Thermostat modes

6.4.3.1 Schedule mode

The **VS10WRF/VS10BRF thermostat** gives you the possibility to programm schedule. You can add up to 6 programs during one day by selecting the program's start time and temperature. You can choose from 3 different schedule configurations:

- Separate schedule for working days (Mo-Fri) and weekend (Sat-Sun)
- Individual schedules for each day at the week
- One schedule for whole week

To activate schedule mode:

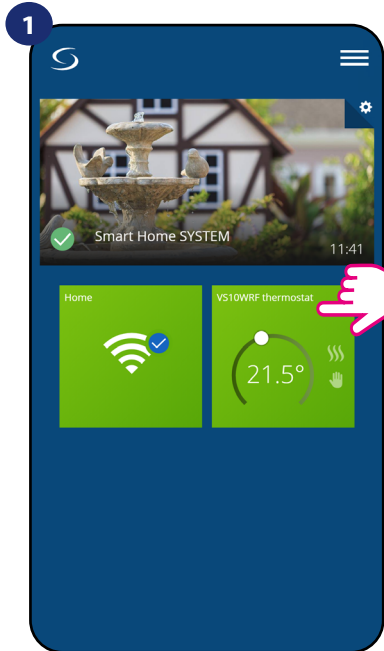

Select thermostat in the main app menu.

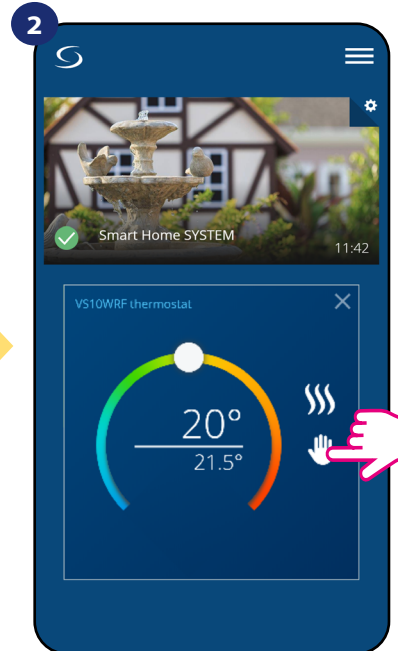

Click on the work mode icon.

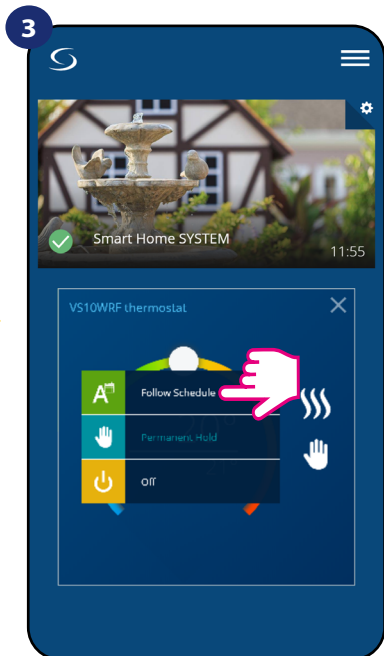

Choose „Follow Schedule” work mode.

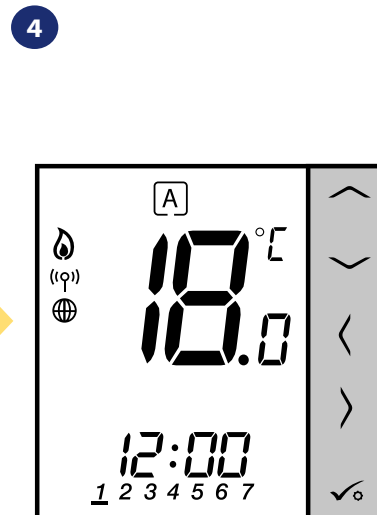

When Schedule Mode is activated then frame will move on the „A” letter.

Additionally, you can choose to set the Default schedule that already exist in the App, or to modify it according to your preferences. The schedule is displayed at the bottom of screen of your App on the selected thermostat. You can activate the schedule by pressing the Follow Schedule icon on your App. Once activated, the calendar icon will appear on your screen.

TO SET THE SCHEDULE IN THE APP:

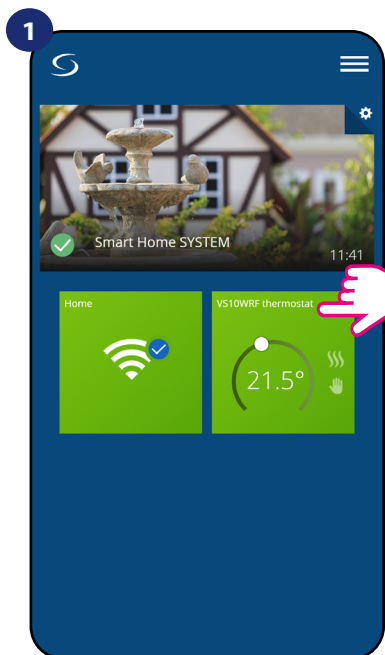

1 Select thermostat in the main app menu.

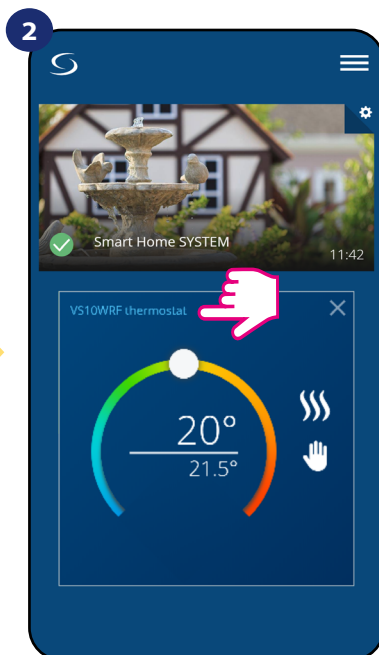

2 Press thermostat's name.

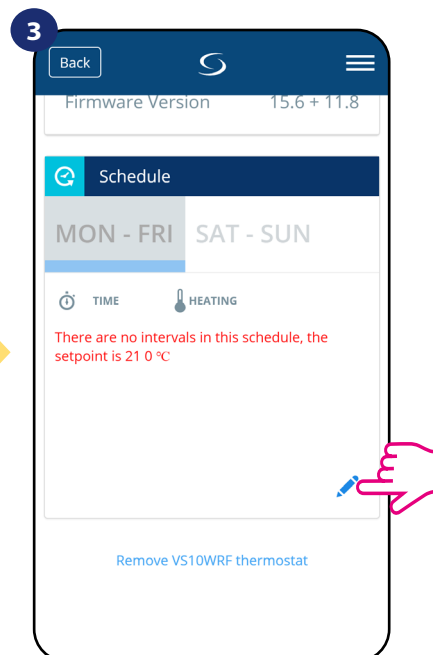

3 Scroll down and press pencil button. As you can see there is default schedule. You can delete all default intervals by button.

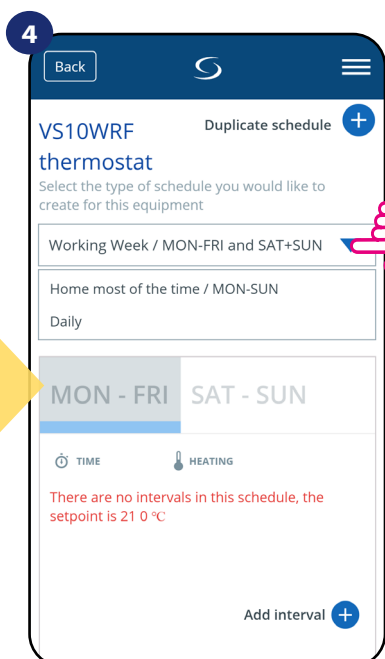

4 Choose for which days you want to program your schedule:

- Working Week / MON - FRI and SAT + SUN
- Home most of the time / MON - SUN
- Daily

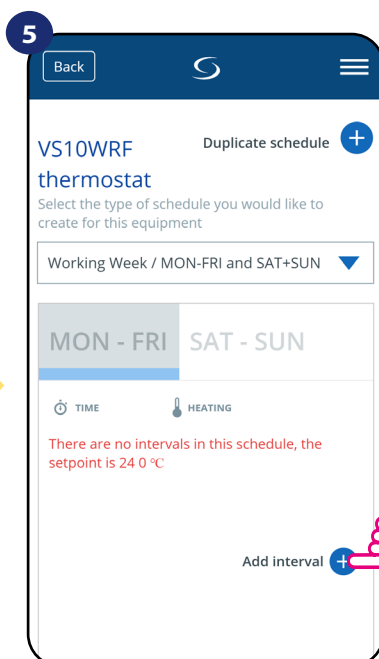

5 After days period selection use „Add interval” option to add your intervals to the schedule.

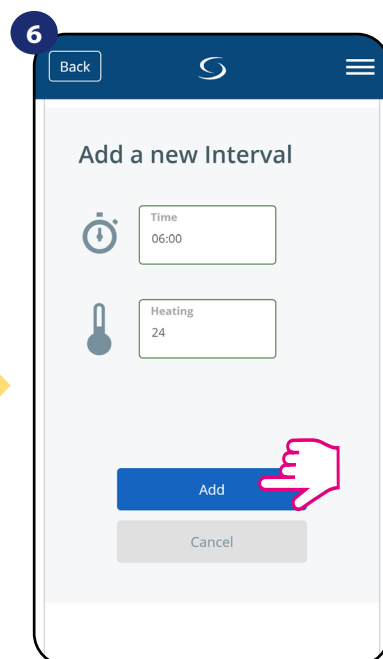

6 Then add a start time and temperature setpoint, after all - confirm by pressing „Add” button.



Please note:

You can add **as many intervals as you wish** by repeating the procedure described from **steps 3 to 6**. The procedure is the same for all 3 schedule configurations. You can customize the programs on the thermostat in any way you want.

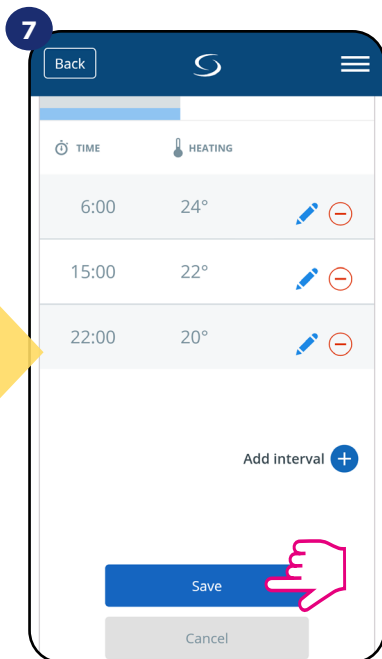

After you've added all the intervals, tap „Save” to save it. Your schedule has been saved and set.

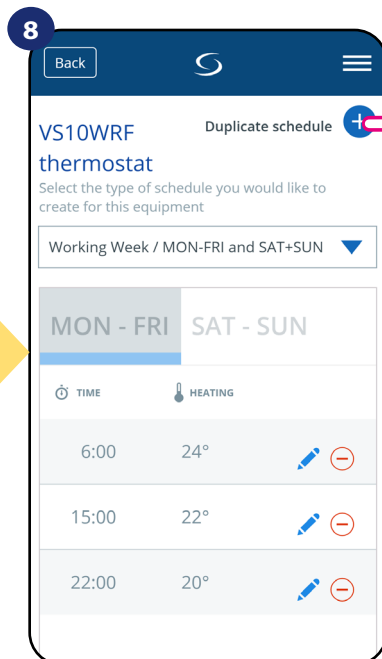

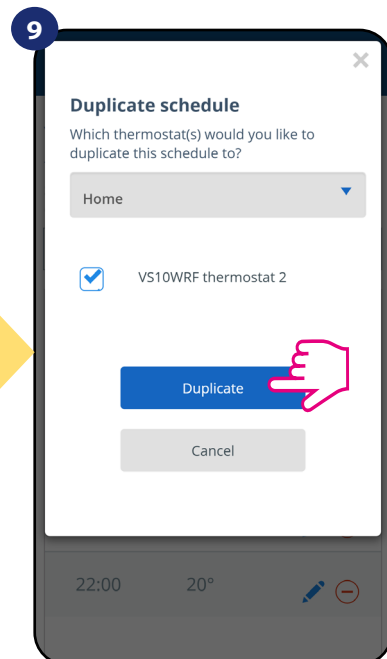

ADDITIONALLY: You can duplicate the same schedule for other thermostat's. Click on the „Duplicate schedule” option.

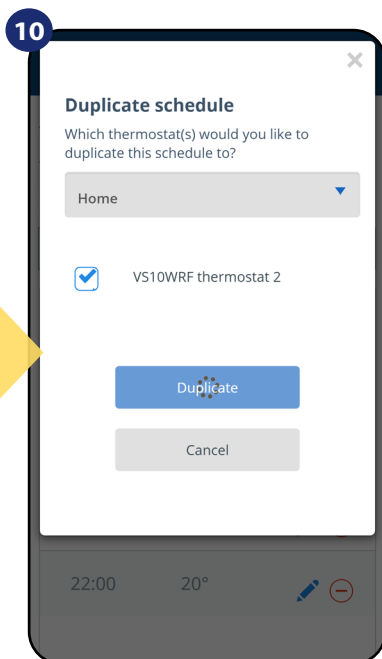

Select thermostat for which you want to duplicate the schedule.



Now app is saving your choice and after it you will have the same schedule for thermostat's you've selected.

 **PLEASE NOTE:** To delete any interval in the schedule just use  button next to selected interval.

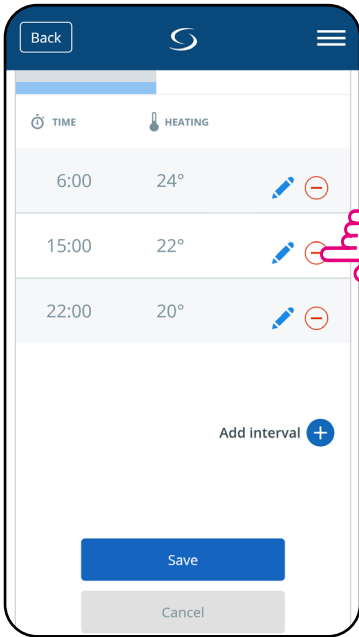

 **Please note:**

When thermostat has no schedule (or it has been deleted) then it maintains a constant temperature 21 °C (in „Follow Schedule” mode).

TO SET DEFAULT SCHEDULE:

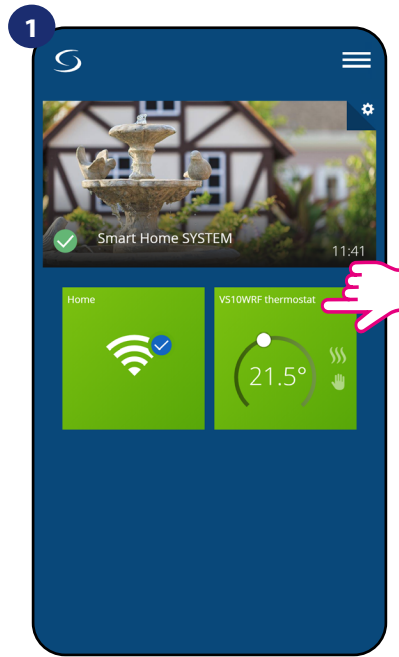

Select thermostat in the main app menu.

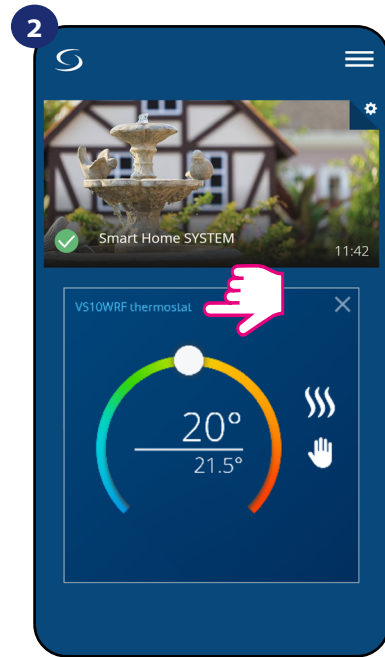

Press thermostat's name.

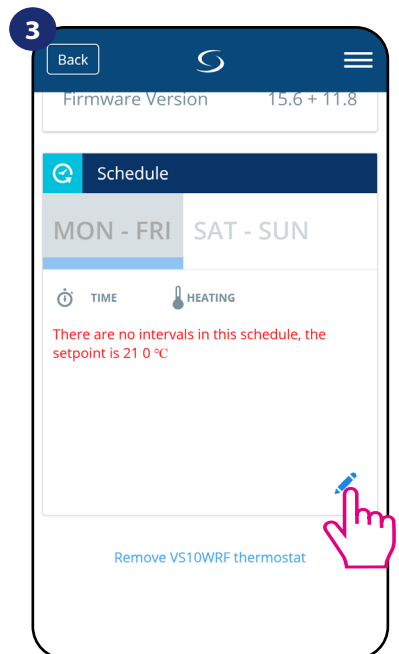

Scroll down and press pencil icon.

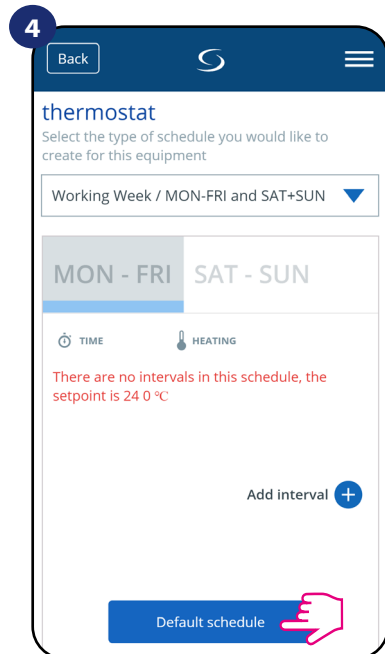

To set default schedule use „Default schedule” button. It will remove all current intervals and it will set default schedule.

6.4.3.2 Temporary override mode

Temporary override mode means manual temperature change during active schedule mode:

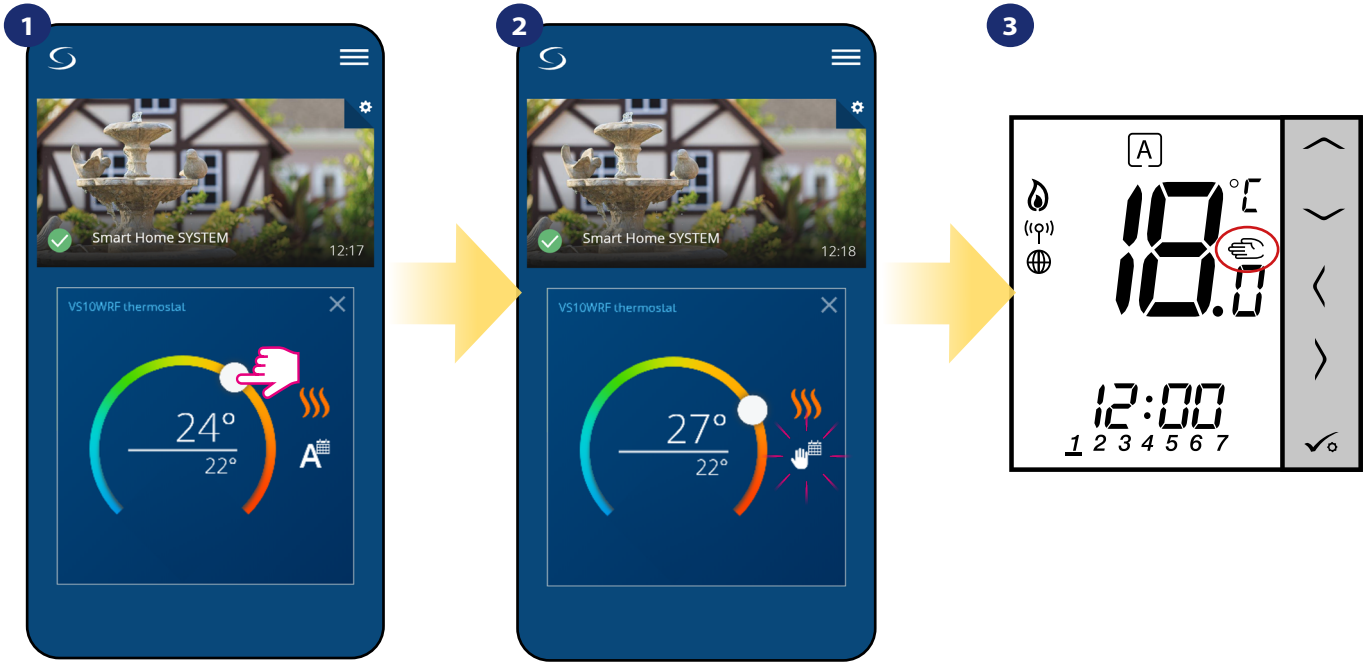

When „Follow schedule” mode is active, use slider to set new setpoint temperature.

When you have overwritten the temperature then hand icon will appear next to calendar which means that temporary override mode is working until next schedule program.

When you overwrote schedule’s setpoint temperature then on the thermostat’s display you will see the hand icon.



NOTE: Temporary override mode will be maintained until next program will come, as it has been set in the schedule.

6.4.3.3 Manual mode

If the thermostat follows a schedule or is in frost protection mode, user can change the operating mode to the **manual mode**. In **manual mode** thermostat will maintain setpoint temperature until user will manually change it to a new value or select a new operating mode. When thermostat works in **manual mode**, the hand icon 🖐 will be displayed in the app screen.

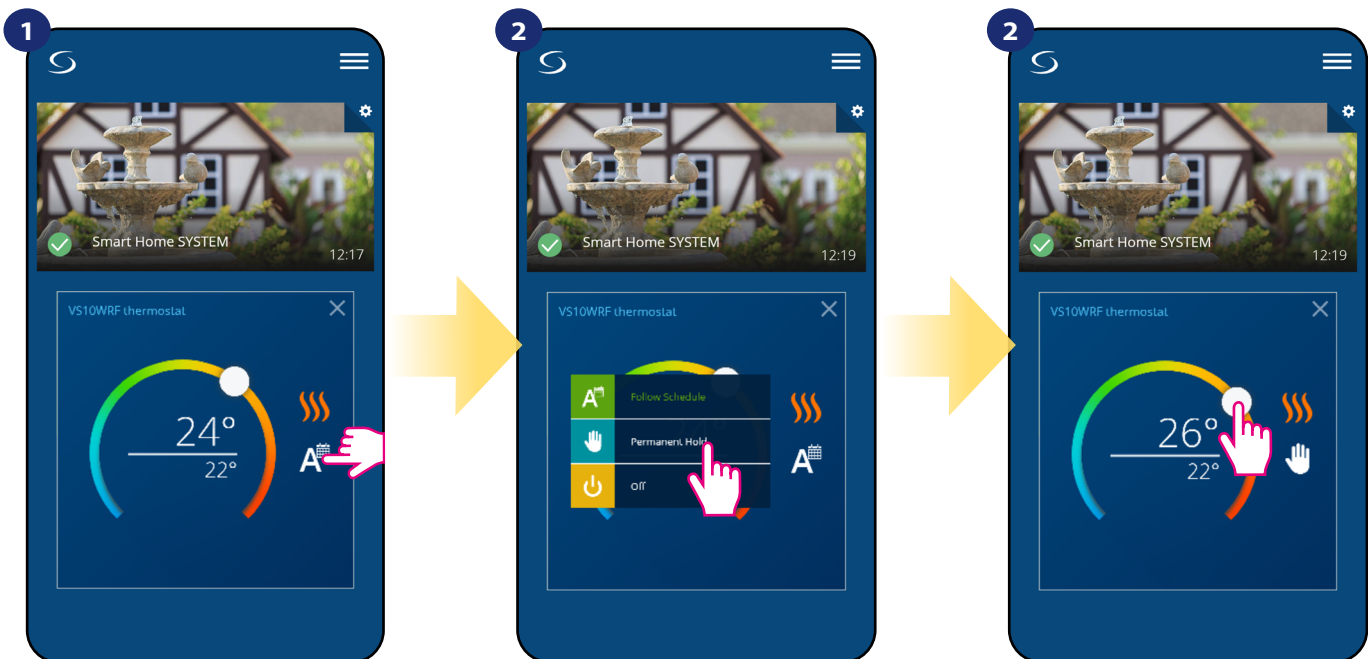

Click thermostat’s work modes icon.

Select „Permanent Hold” mode.

Hand icon confirms that thermostat is in manual mode.

6.4.3.4 Frost protection

In **Frost protection mode** the thermostat is displaying actual room temperature and maintain „frost protection” setpoint temperature specified in thermostat settings (please refer to chapter 8.3). When thermostat works in **Frost protection mode** then you have no possibilities to change temperature setpoint. To activate **Frost protection mode** online please follow steps below:

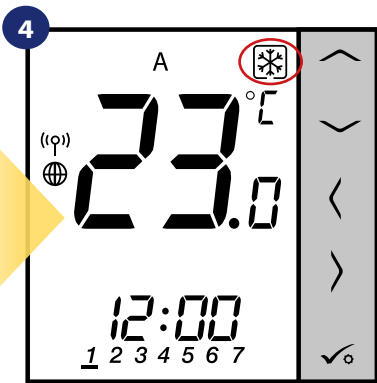
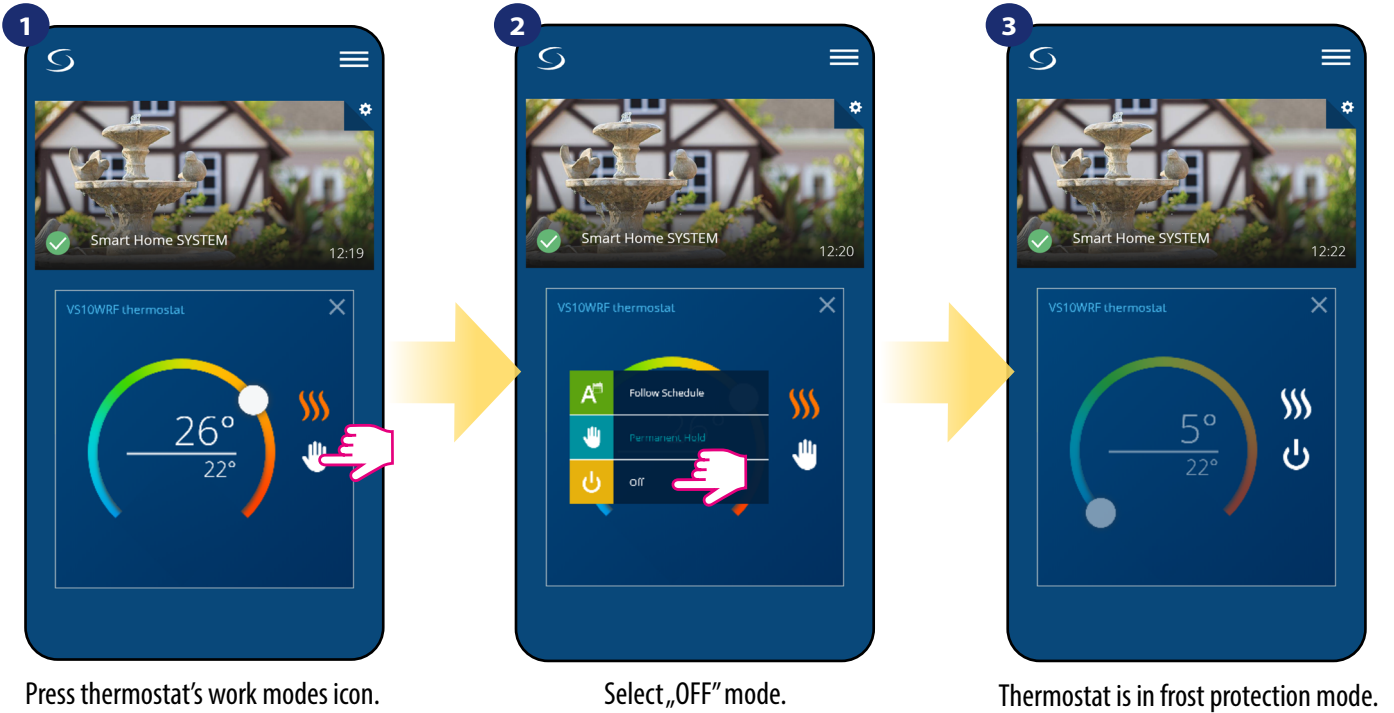

Also on the thermostat's display you can see that frost protection mode is activated by „Snow” icon.



Note: When the thermostat exits frost protection mode, previous mode will be restored.

PLEASE NOTE: You can change frost protection mode temperature setpoint from the application level (D08 parameter). Follow steps below:

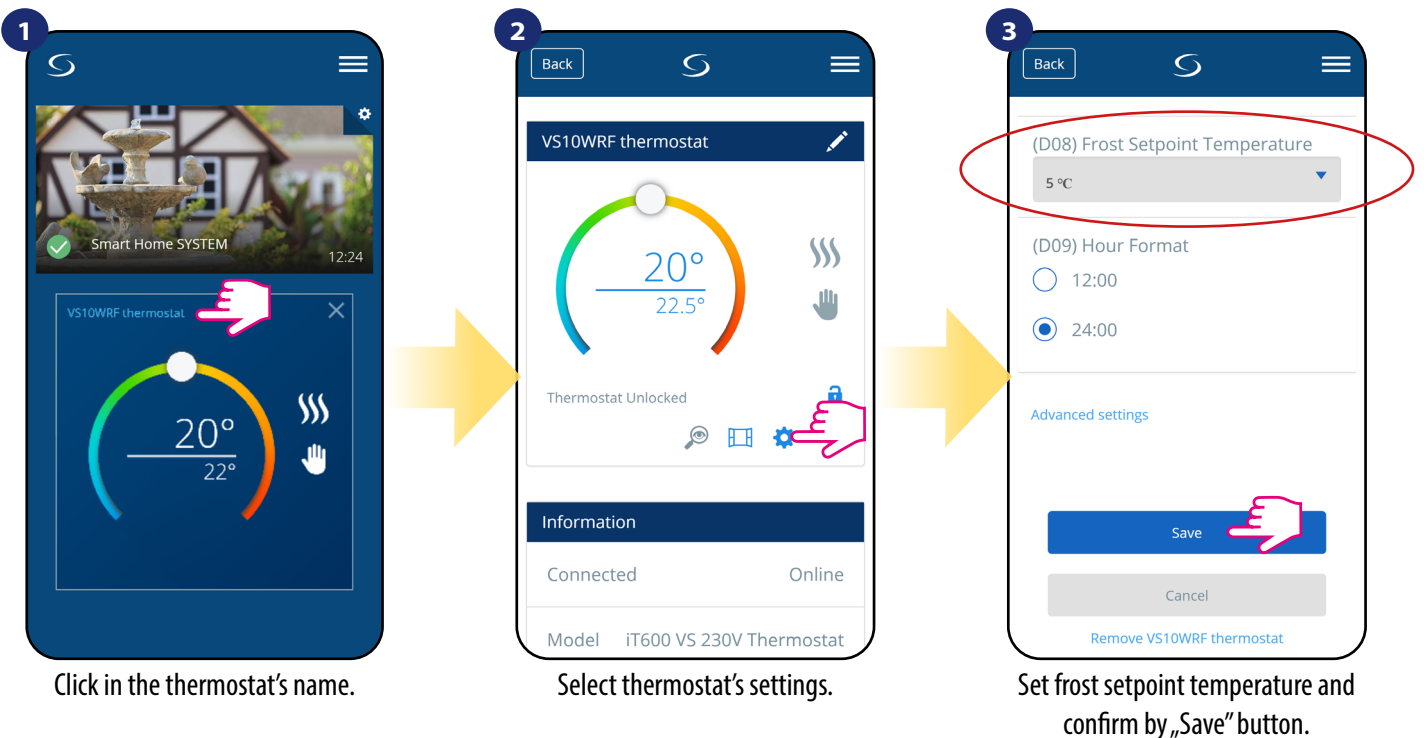

6.4.4 Key lock function

You can lock/unlock buttons in your thermostat by application.



Click in the thermostat's name.

Click on the „padlock” icon to lock/unlock thermostat buttons.

When buttons are locked then also you can see on the thermostat display „key” icon.

6.4.5 Compatibility with window/door sensor OS600 / SW600

VS10WRF/VS10BRF thermostat paired with window/door sensor **OS600/SW600** allows to create OneTouch rules when window/door is **opened** or **closed**. If thermostat will receive information from window/door sensor (that window has been opened for example) then OneTouch rule will turn off heating until window close. If you want to have access to this function then first you have to add window/door sensor **OS600** or **SW600** (please refer to the **OS600** or **SW600** manual instruction).



To pair window/door sensor OS600/SW600 with VS10WRF/VS10BRF thermostat please follow steps below:

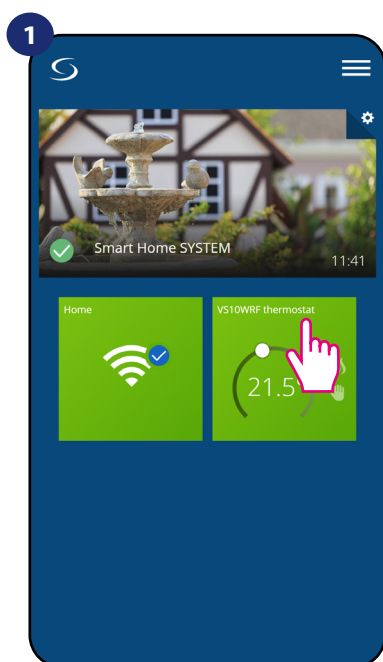

Select the thermostat in the main app menu.

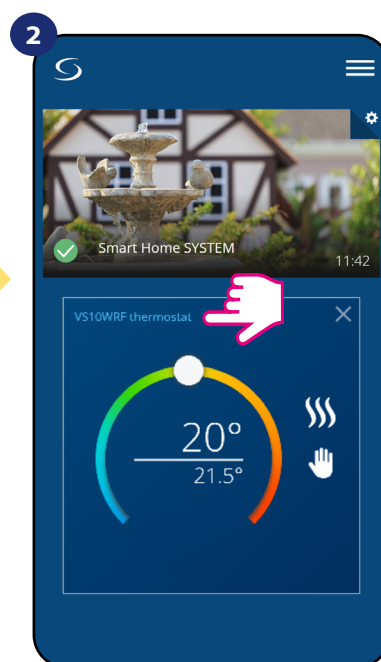

Press thermostat's name.

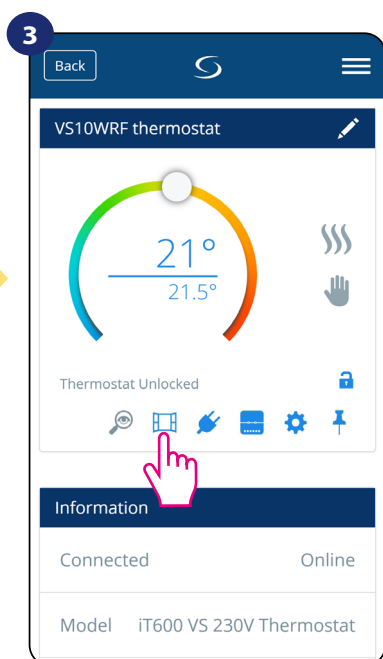

Choose the window icon.

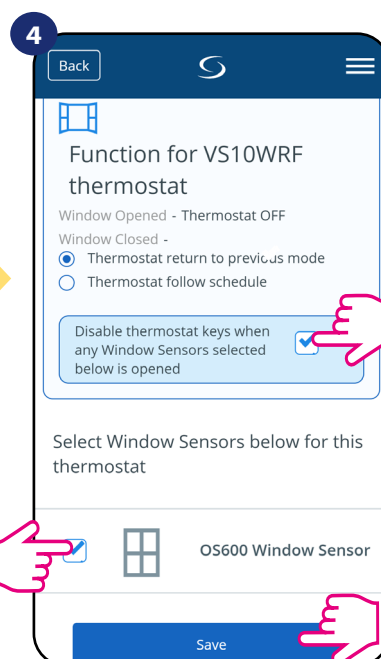

Mark sensors which you want to link together with the thermostat. You can additionally lock buttons on thermostat when window is opened by marking option above. Press „Save” button to finish pair process...

6.4.6 Compatibility with Smart Plug SPE600

VS10WRF/VS10BRF thermostat paired with **SPE600 Smart Plug** allows to turn on/off any electric device eg. pump, radiator or valve with actuator. When thermostat starts heating then plug will **turn on** device (or **turn off** when there is no need to heat). If you want to have access to this function then first you have to add **SPE600 Smart Plug** to the **SALUS SmartHome system** (please refer to the **SPE600 manual instruction**).



To pair SPE600 Smart Plug with VS10WRF/VS10BRF thermostat please follow steps below:

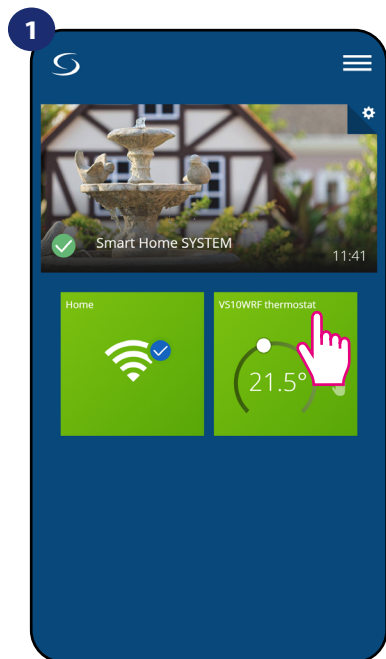

Select the thermostat in the main app menu.

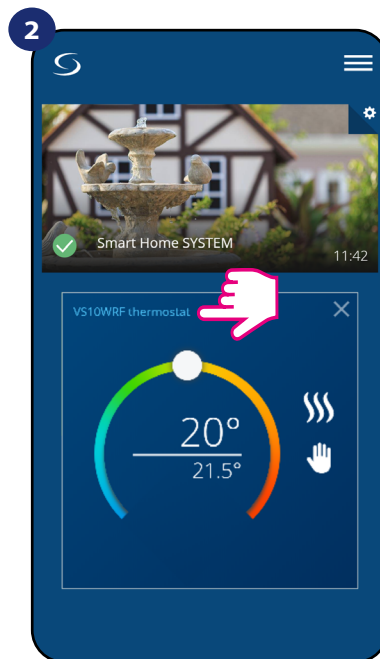

Press thermostat's name.

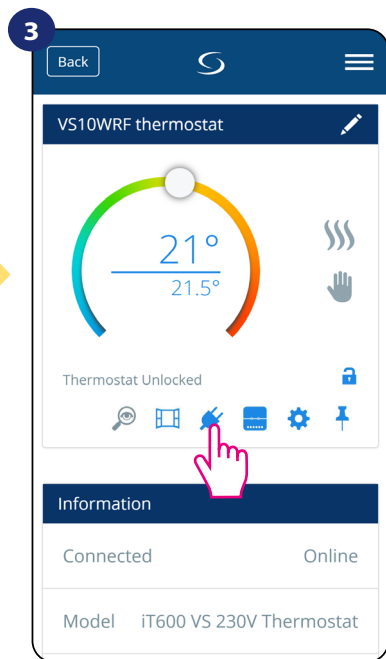

Choose the plug icon.

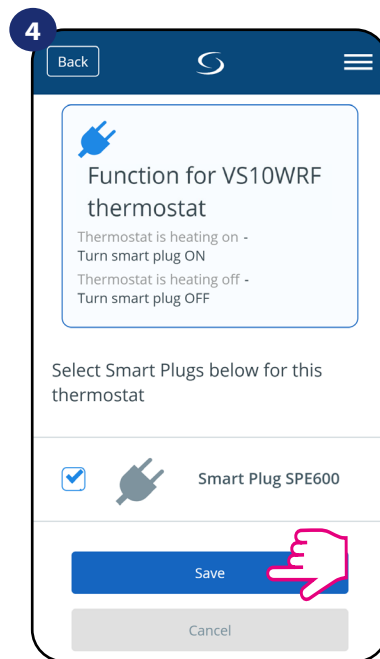

Choose plugs which you want to add to the thermostat. Press „Save” button to finish pair process...

6.4.7 Compatibility with Smart Relay SR600

VS10WRF/VS10BRF thermostat paired with **Smart Relay SR600** allows to wireless control of eg. radiator, pump, boiler. When thermostat start heating then **SR600 Smart Relay** will **turn on** device (or **turn off** when there is no need to heat). If you want to have acces to this function then first you have to add **SR600 Smart Relay** to the **SALUS SmartHome** system (**please refer to the SR600 manual instruction**).



To pair SR600 Smart Relay with VS10WRF/VS10BRF thermostat please follow steps below:

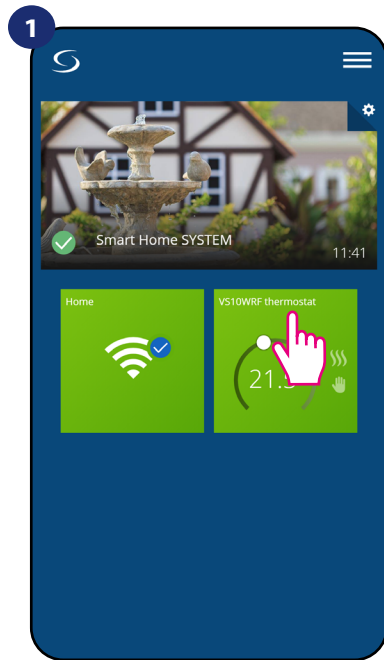

Select the thermostat in the main app menu.

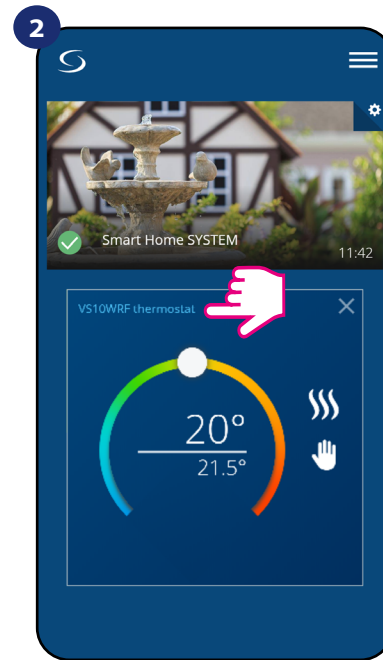

Press thermostat's name.

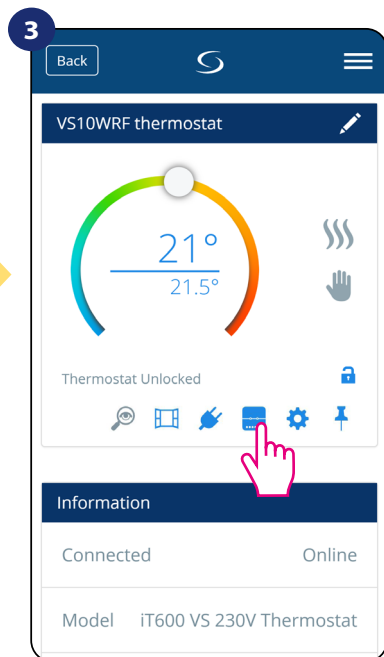

Press the relay icon.

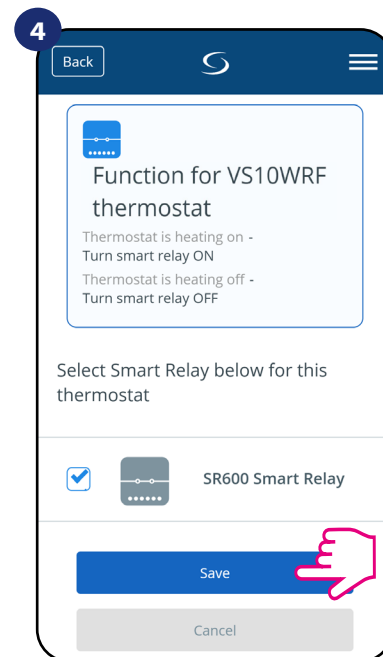

Choose SR600 relays which you want to add to the thermostat. Press „Save” button to finish pair process...

6.5 Work as a hot water timer (work modes)

VS10WRF/VS10BRF thermostat has 4 work modes as a hot water timer:

- I** - **Turned ON** - (thermostat is manually turned on and work as long as you change this mode to another or switch it off),
- A** - **AUTO mode** - (thermostat is following schedule which you programmed - look at chapter 6.4.3.1 Schedule mode, page 30),
- O** - **Turned OFF** - (thermostat is manually turned off as long as you select other mode),
- B** - **Temporarily ON mode** - (you can fast set the water heating time in this mode in limited hour period (from 1 to 4 hours)).

6.5.1 Turned ON mode - **I**

Thermostat is manually turned on and work as long as you change this mode to another or switch it off. To set this mode on, please follow steps below:

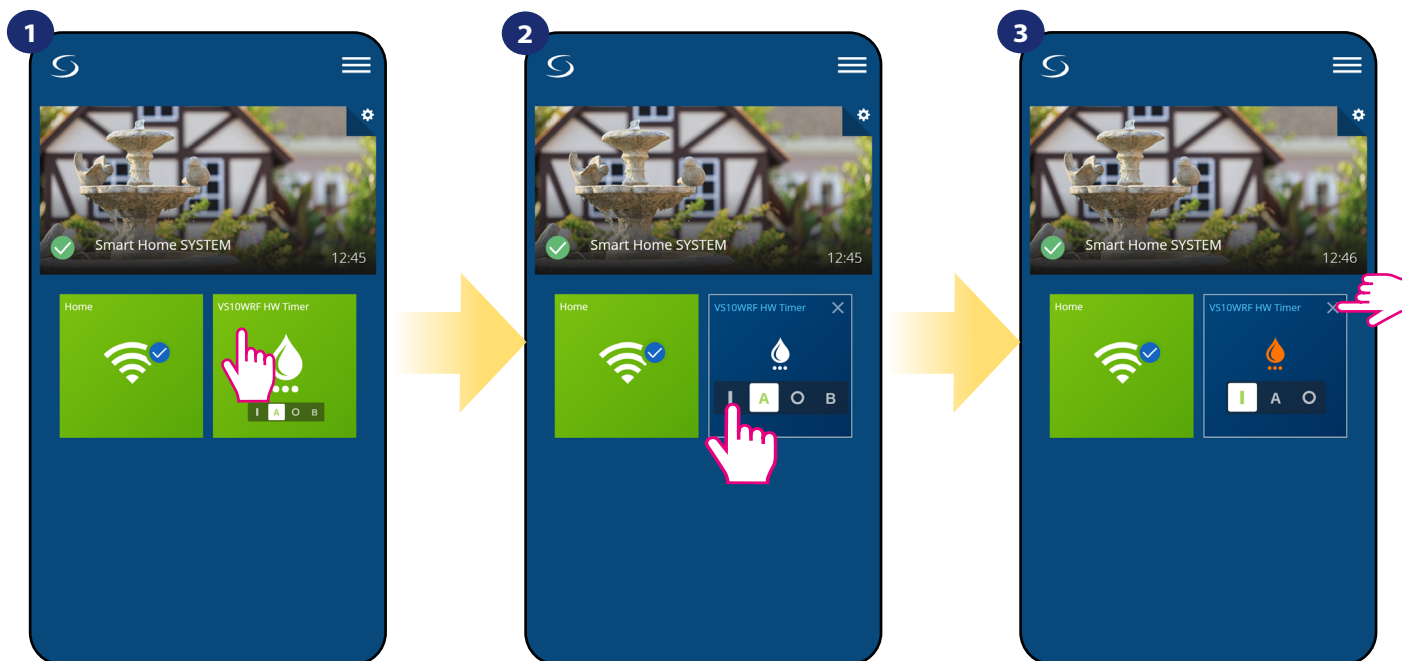

Select the thermostat in the main app menu.

Turn ON the hot water timer.

Close thermostat's tile.



Now you can see thermostat's tile in orange colour which means it has started call for heating.

Also on thermostat's display you can see the current mode.

6.5.2 AUTO mode - A

Thermostat is following schedule which you programmed - look at chapter 6.4.3.1 Schedule mode, page 29. To set this mode on, please follow steps below:



Select the thermostat in the main app menu.

Select AUTO mode.

Close thermostat's tile.

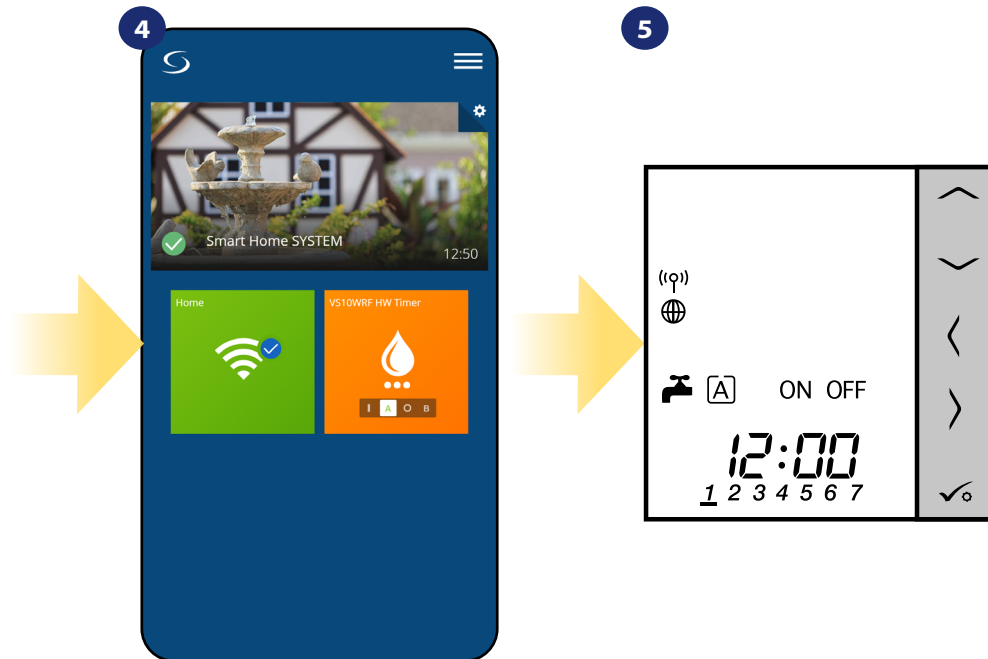

Thermostat is in auto mode (it is following schedule).

Also on thermostat's display you can see the current mode.

6.5.3 Turned OFF mode -

Thermostat is manually turned off as long as you select other mode. To set this mode on, please follow steps below:



Select the thermostat in the main app menu.

Turn OFF thermostat.

Close thermostat's tile.

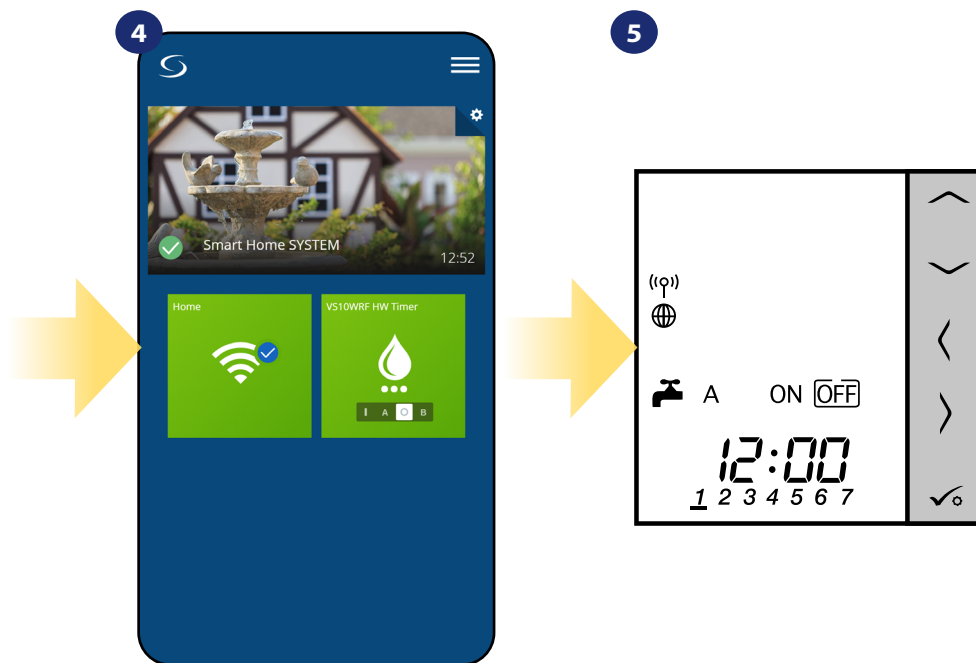

Thermostat is turned off.
Tile is in green colour.

Also on thermostat's display you can see the current mode.

6.5.4 Temporarily ON mode - B

You can fast set the water heating time in this mode in limited hour period (from 1 to 4 hours). To set this mode on, please follow steps below:

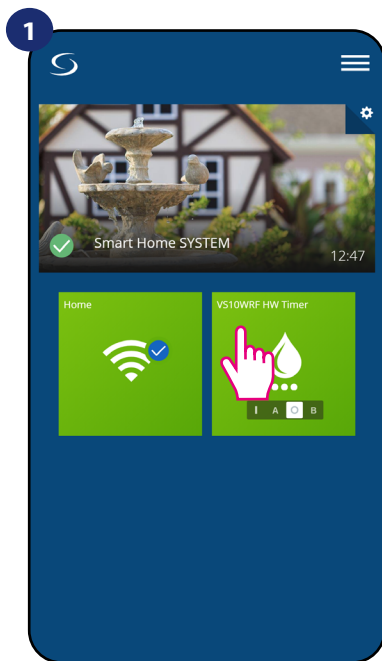

Select the thermostat in the main app menu.

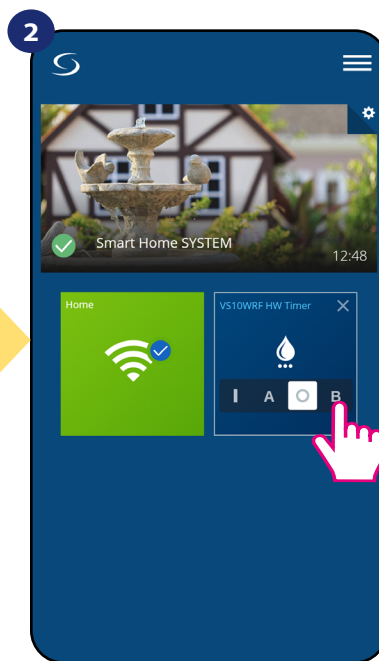

Select temporarily mode (B letter).

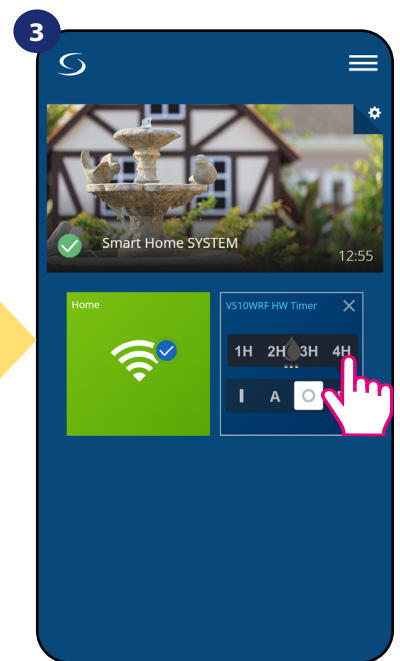

Choose hour value.

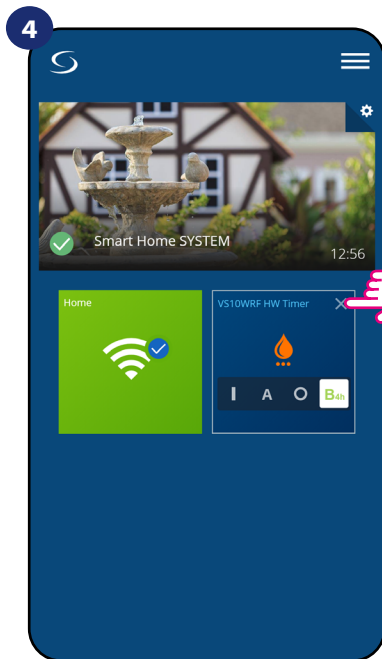

Close thermostat's tile.

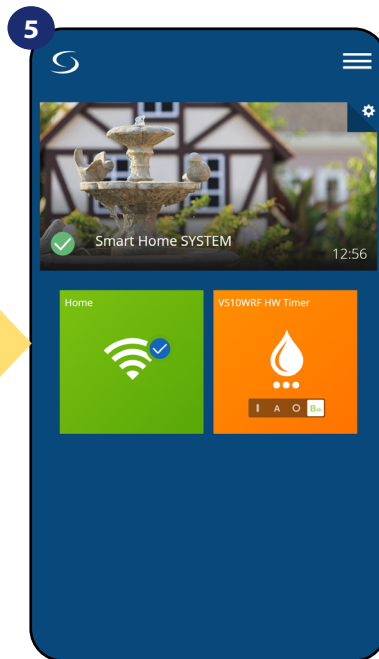

Thermostat is in temporarily mode (for 4 hours in this case). You can turn it off by choosing other mode.

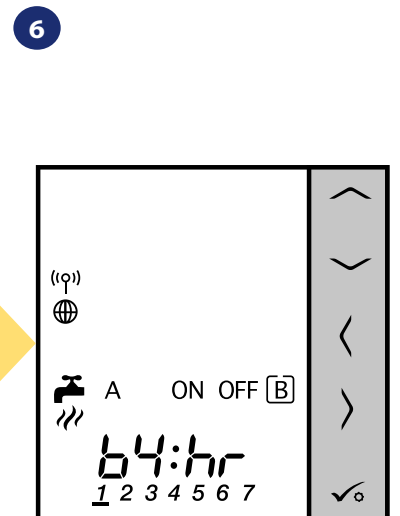

Also on thermostat's display you can see the current mode.

6.6 Identification mode

Identification mode can be useful when we are pairing more than one device in one moment and we don't know which device is which. Beyond, if our system include more that one **UGE600 Universal Gateway** then we can easily identify which device is paired with which gateway.

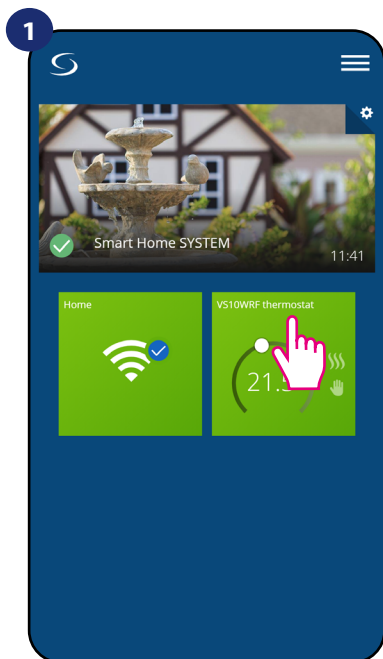

Select the thermostat in the main app menu.

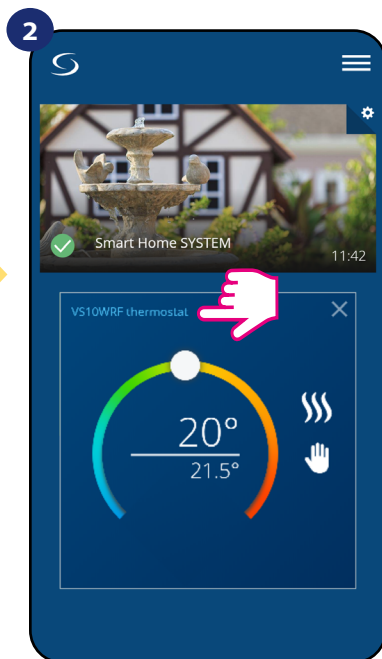

Press thermostat's name.

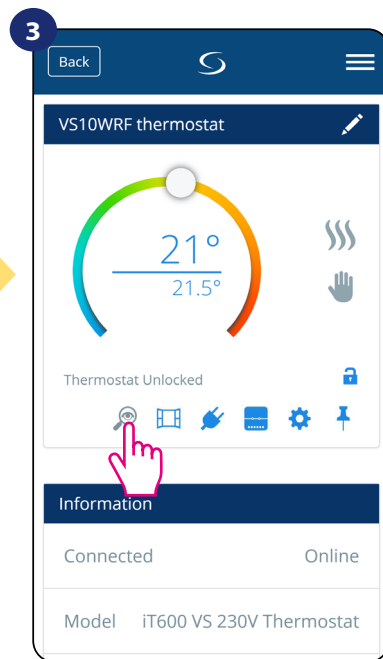

Use the magnifying glass icon.

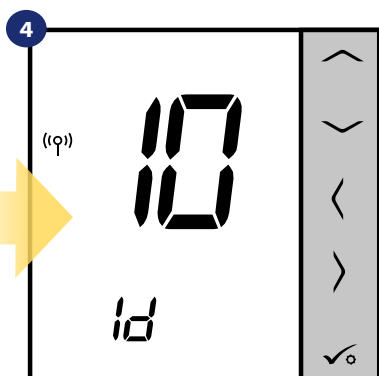

In the **Identification mode** thermostat's display will start flashing „Id” information for 10 minutes.

You can also identify your device during thermostat's pairing process:

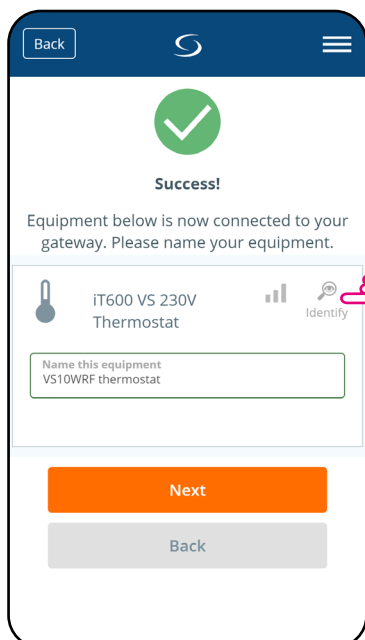

Click on the magnifying glass icon.

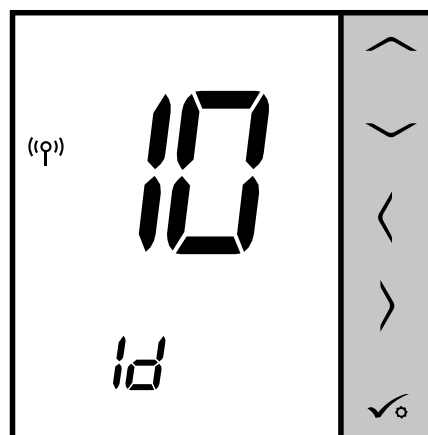

6.7 Pinning/unpinning thermostat to/from application dashboard

To pin/unpin thermostat from dashboard in Smart Home application please follow steps below:

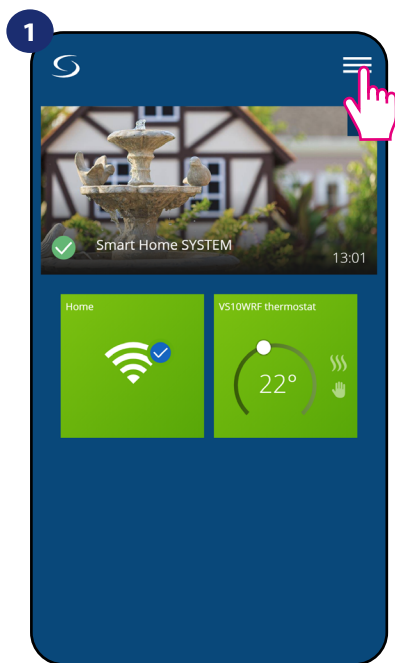

Open main menu in the app.

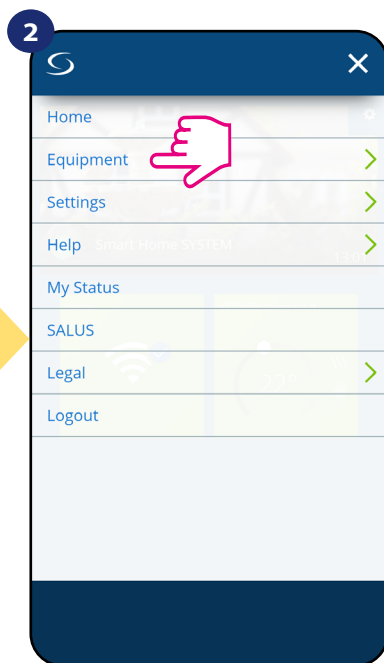

Select equipment.

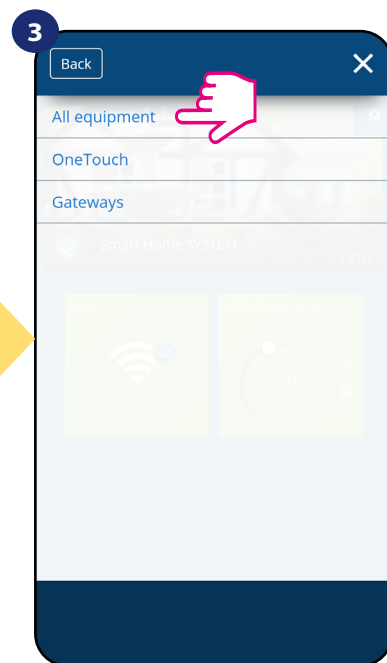

Select All equipment option.

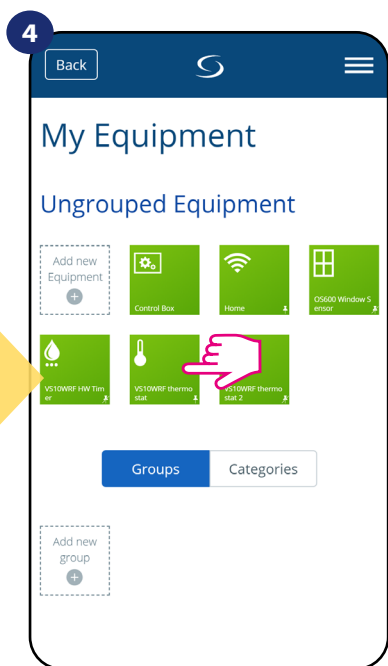

Select your VS10WRF/VS10BRF thermostat.

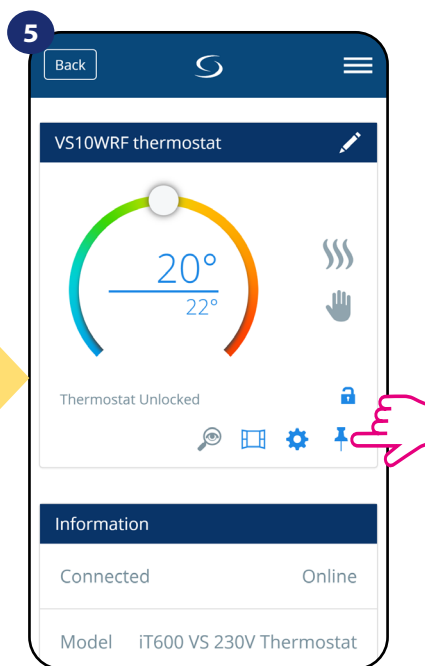

Press on the „Pin“ icon to pin/unpin thermostat to/from the app dashboard.

6.8 User settings (basic settings)

User settings of VS10WRF/VS10BRF thermostat determine basic thermostat parameters. Please see below how to enter those settings:

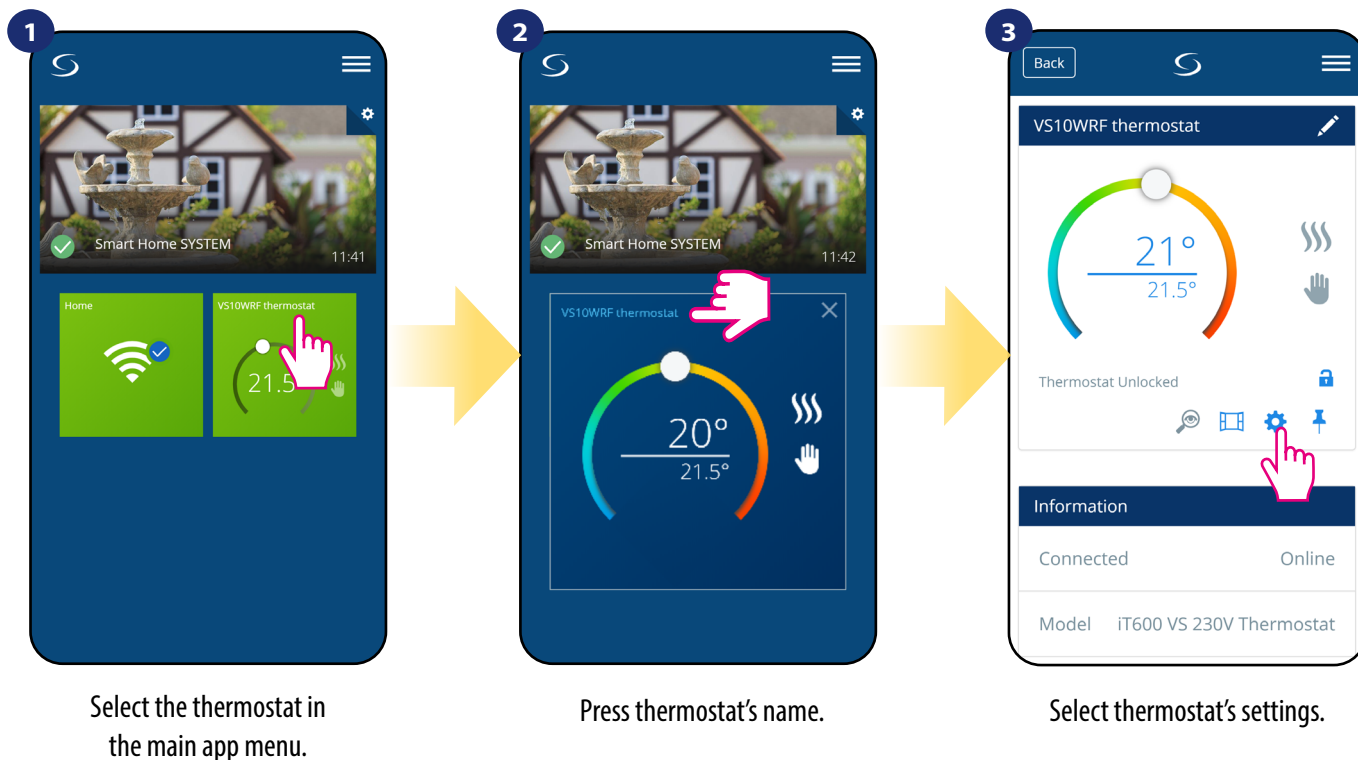

4 Scroll down to the settings section.

BASIC SETTINGS:

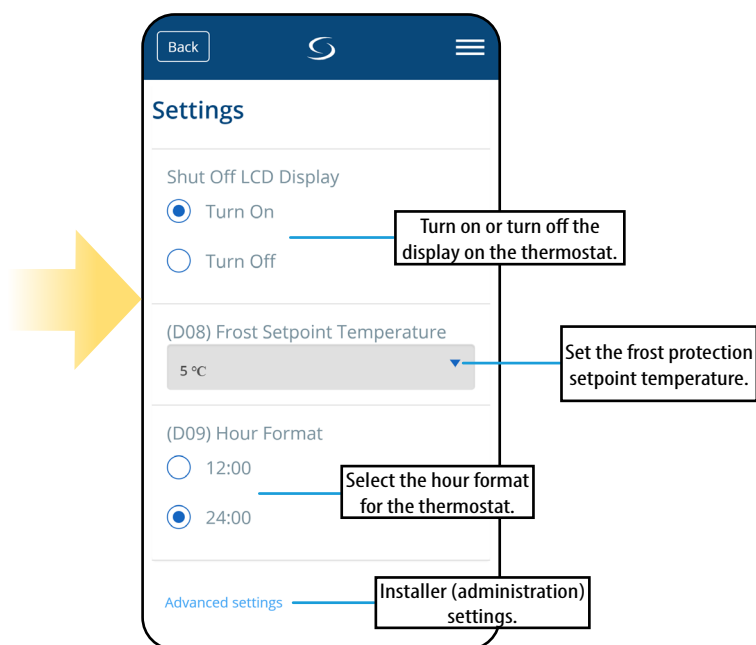

6.9 Admin settings (installer parameters)



PLEASE NOTE: Admin settings are mainly for qualified installers or knowledgeable users.

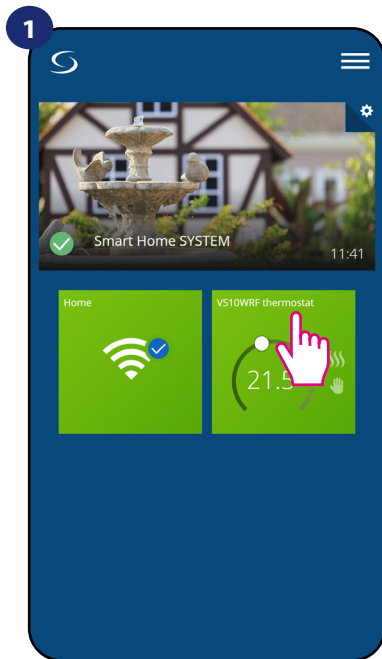

Select the thermostat in the main app menu.

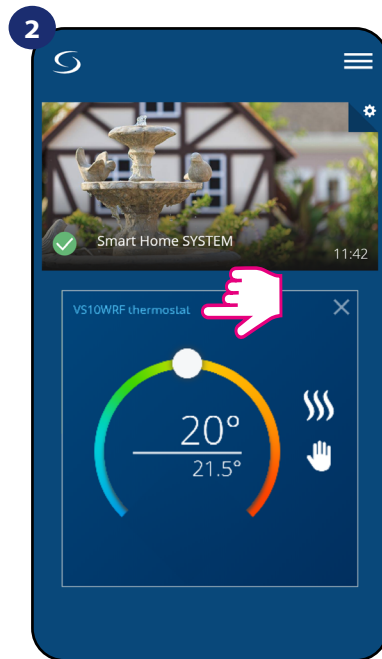

Press thermostat's name.

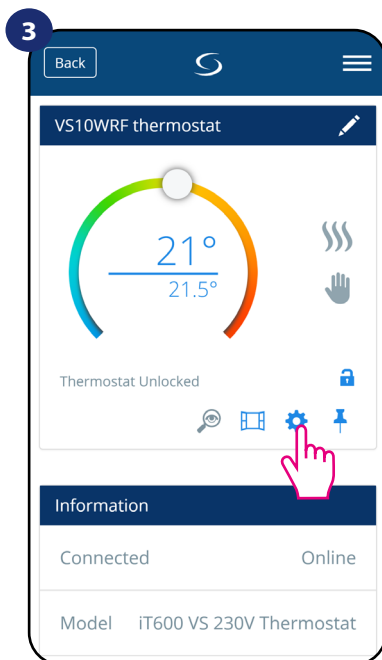

Select thermostat's settings.

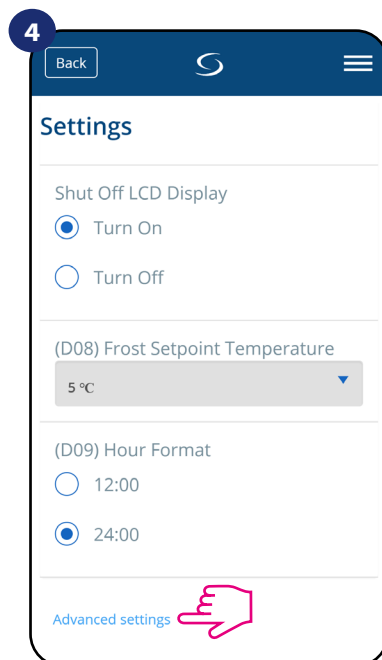

Scroll down to enter „Admin settings“.



Please Note:

All service parameters with detailed admin settings are described on page 74!

6.10 OneTouch rules (add/edit)

OneTouch - function that distinguish **SALUS Smart Home system** in terms of functionality. **OneTouch** rules are pre-configured set of actions defined in the interface easy in use. You can **switch it on or off** anytime. **OneTouch** informs thermostat or other device how it has to work according to pre-set settings. In application are **4 pre-defined OneTouch** rules:

- **Party Mode** - set thermostat temperature to 21 °C for 2 hours
- **Comfort Temperature** - set thermostat temperature to 21°C
- **Frost Protection Mode** - set thermostat to the Frost Mode (temperature setpoint can be set in the user settings) - 5°C by default
- **Holiday Mode** - set thermostat to the Holiday Mode



To activate **OneTouch** rules please follow steps below (example on **Party Mode**):

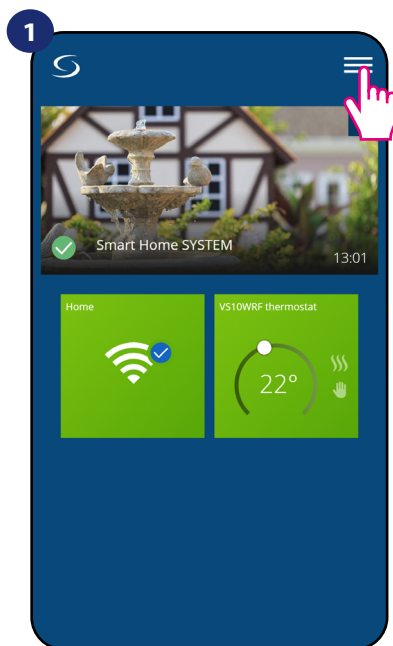

Open main menu in the app.

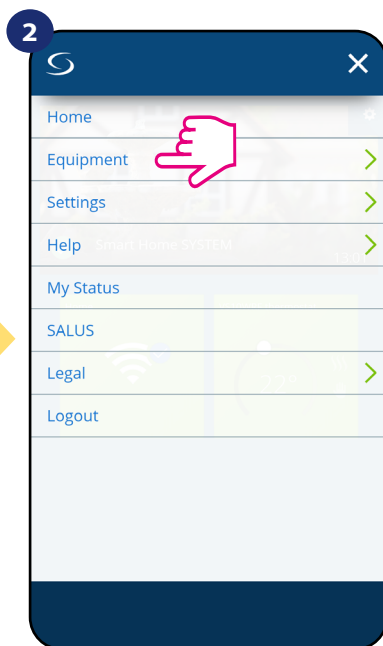

Select equipment.

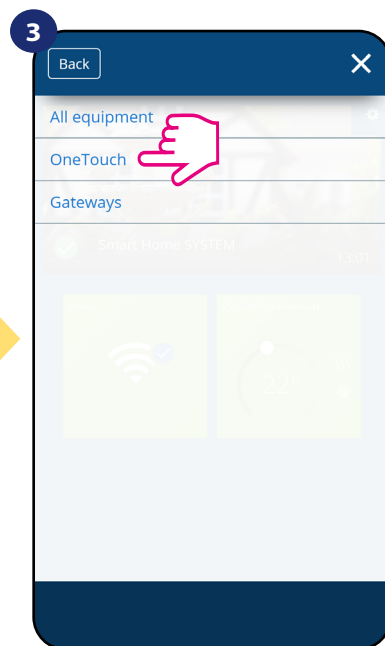

Select OneTouch option.

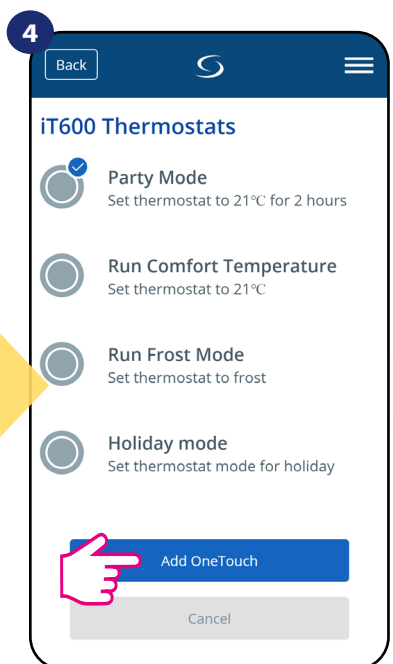

Choose „Party Mode” as a one of the built-in OneTouch rules. Click „Add OneTouch” to add it.

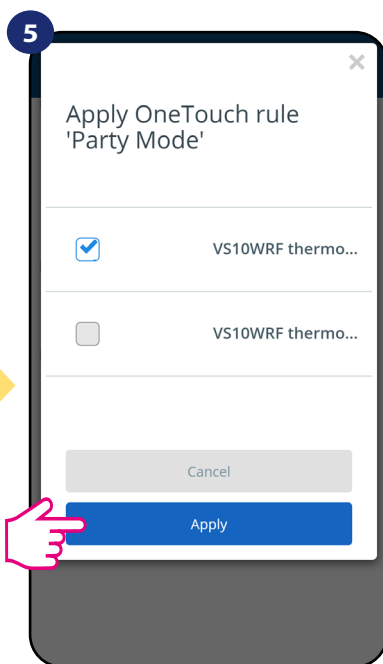

Select thermostats which you want to configure with this rule. Press „Apply” to confirm.

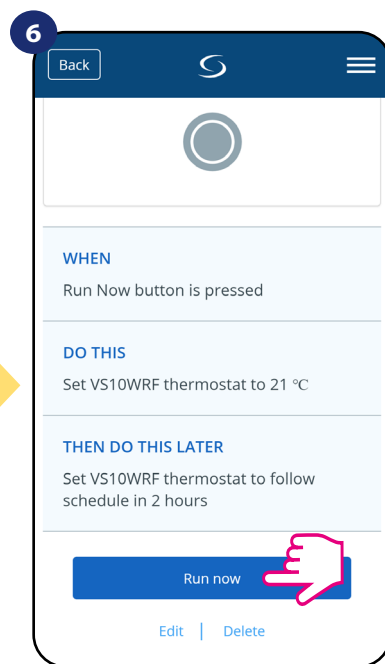

Party Mode has been activated. You can check how it works by pressing „Run now” button.

You can also create your own **OneTouch** rule. As an example we will create OneTouch rule which activates „send me a notification” action under „temperature is below 10 °C” condition. Please look at the steps below how to set this **OneTouch** rule.

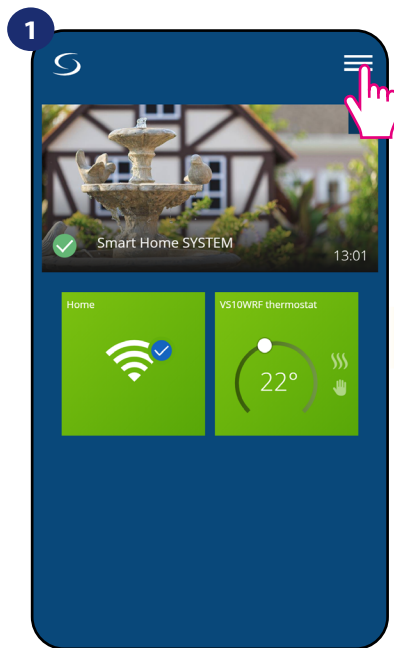

Open main menu in the app.

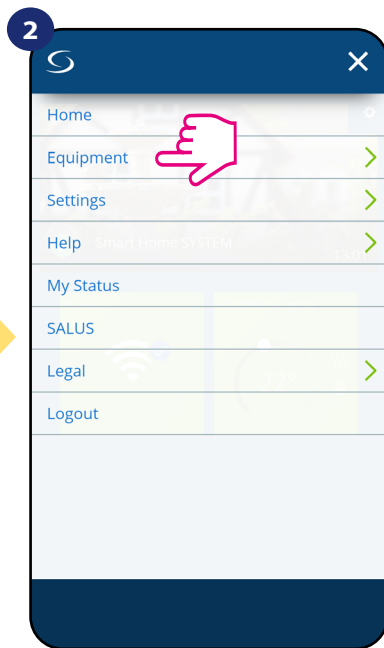

Select equipment.

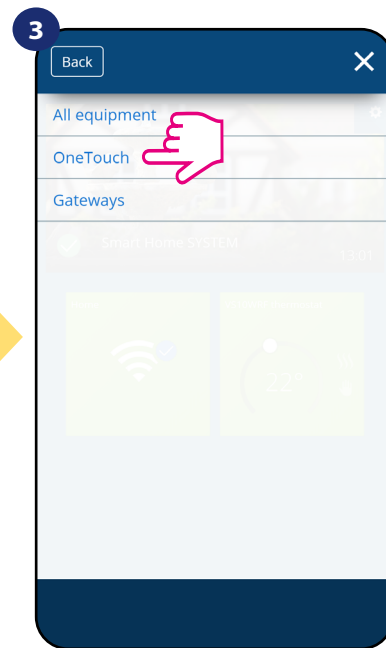

Select OneTouch option.

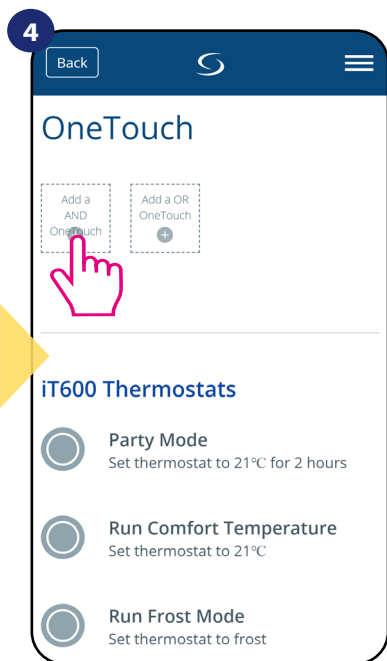

Press „Add a AND OneTouch” button.

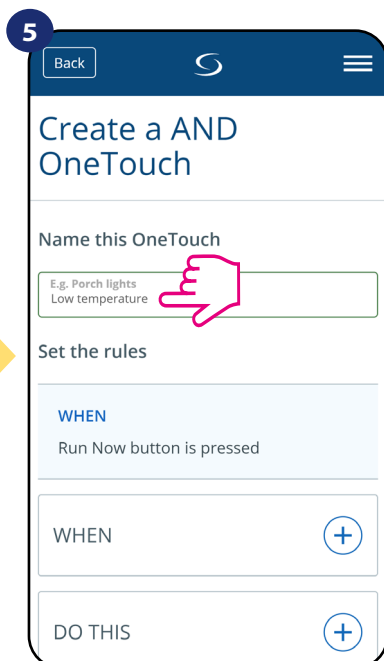

Enter OneTouch rule name.

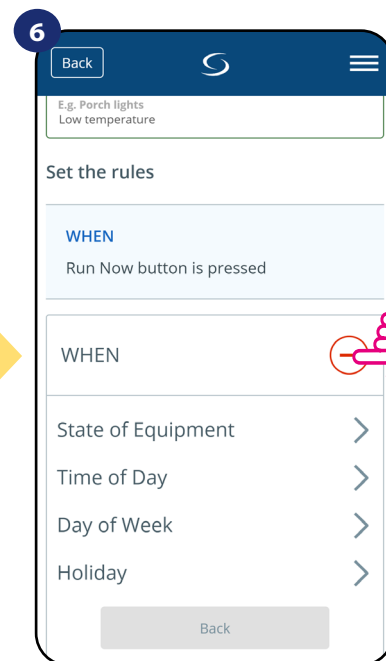

At this step choose condition which have to be fullfill in order to activate the rule.

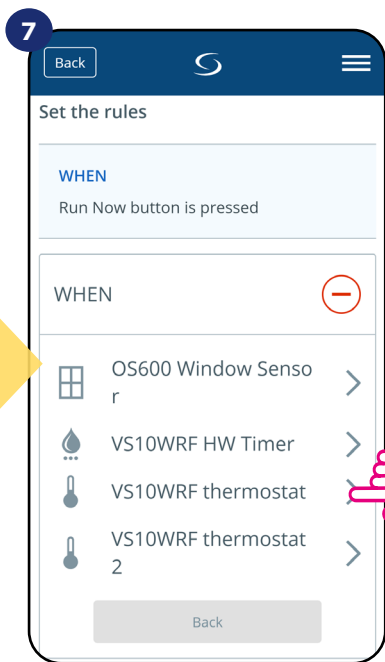

Select which thermostat you want to link up with your OneTouch rule.

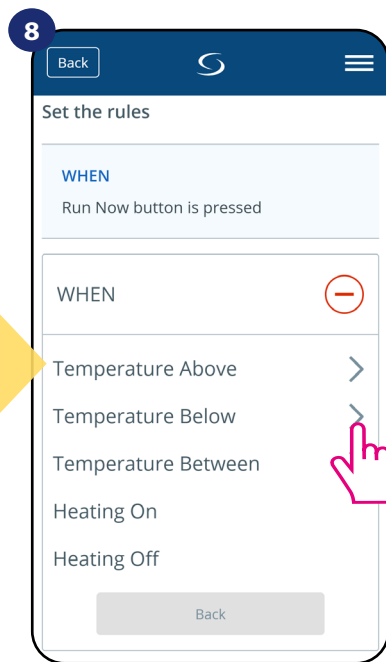

Choose the condition details for your thermostat. In this case select „Temperature Below” option.

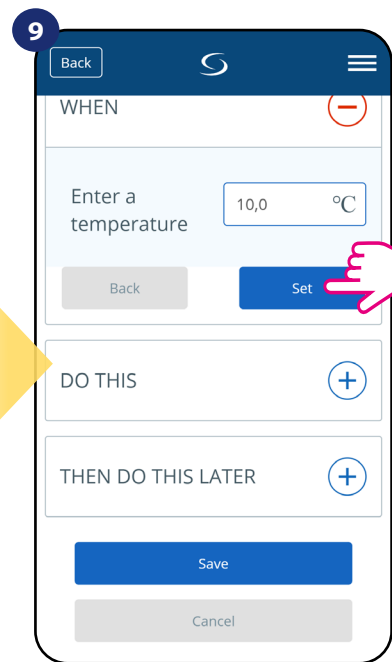

Enter a temperature setpoint trigger for your OneTouch rule. Press „Set” button to confirm.

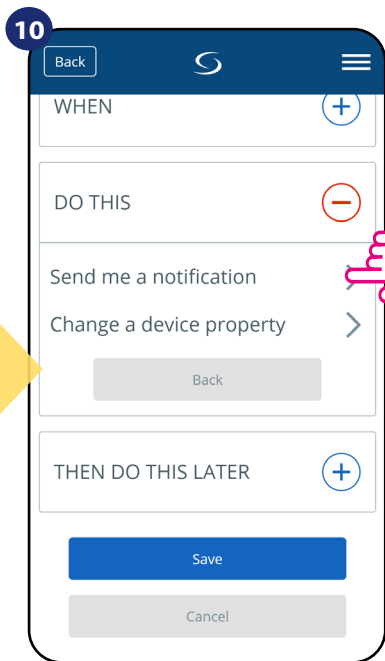

Select „DO THIS” option to create OneTouch rule action.

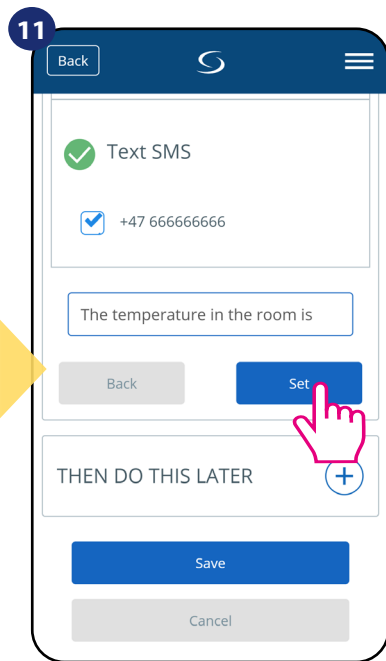

Choose e-mail or SMS notification and enter the message content. Confirm by pressing „Set” button.

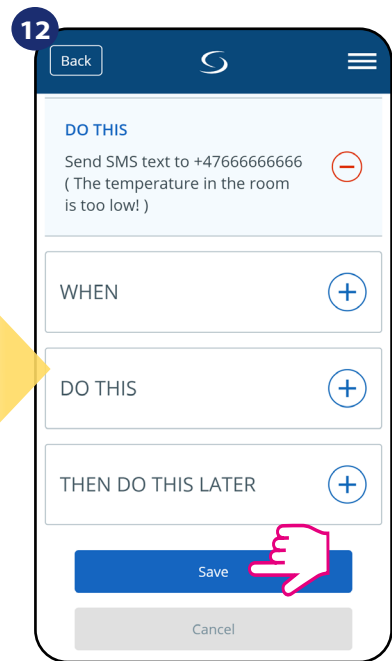

To finish OneTouch rule creation press „Save” button.

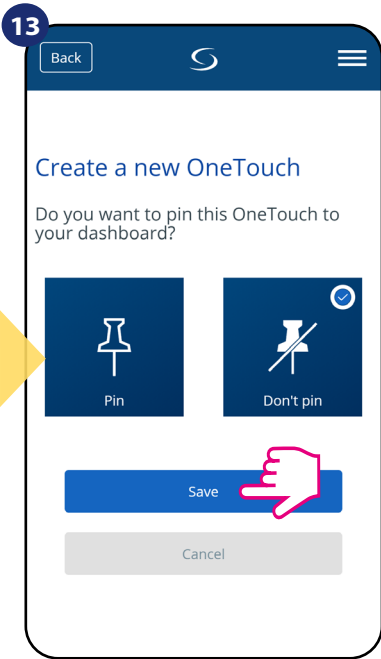

As an option OneTouch rule tile can be pinned to the dashboard.

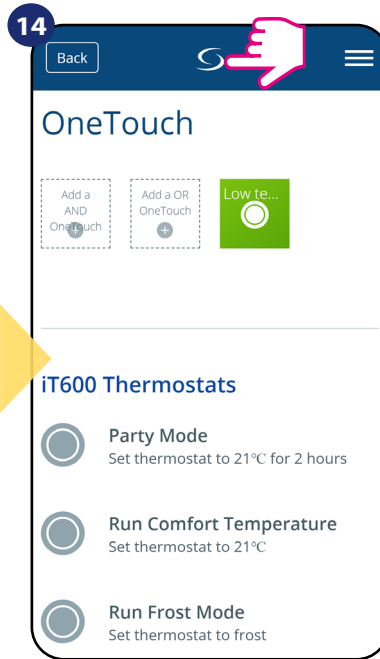

Newly created OneTouch rule tile can be found under OneTouch main menu...

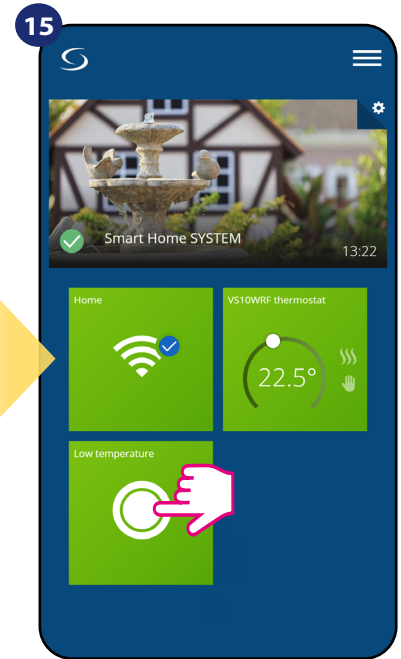

... and on your dashboard.

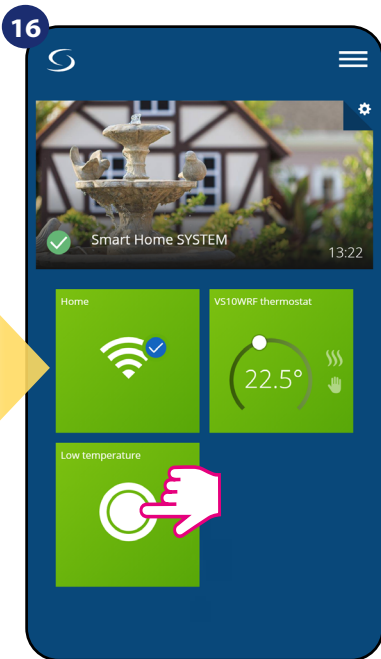

To force OneTouch rule activation select it tile...

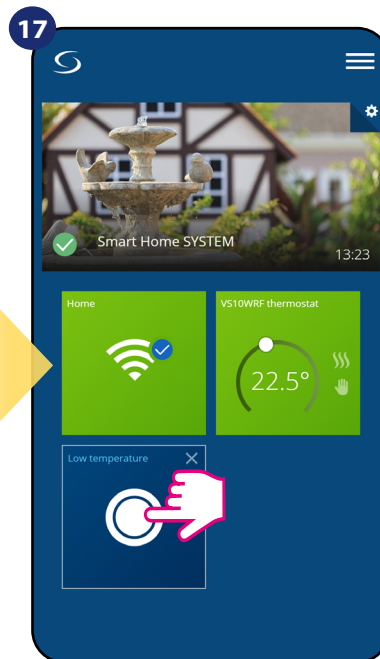

...and press it's button.

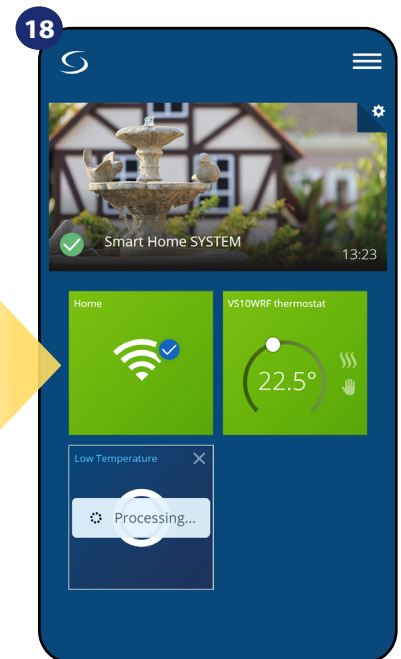

OneTouch rule is now activated. In this example SMS message will be send to the user.

 **Please note:** SMS notifications will be send to the user **only** if they are activated in the OneTouch settings and UGE600 Universal Gateway is connected to the Internet.

6.11 Error codes (exclamation mark in app)

If there is any error in the Smart Home system which relates to the devices performance or functionality then the Smart Home app will inform user about it by a red exclamation mark in the upper menu. Please look at the example below:

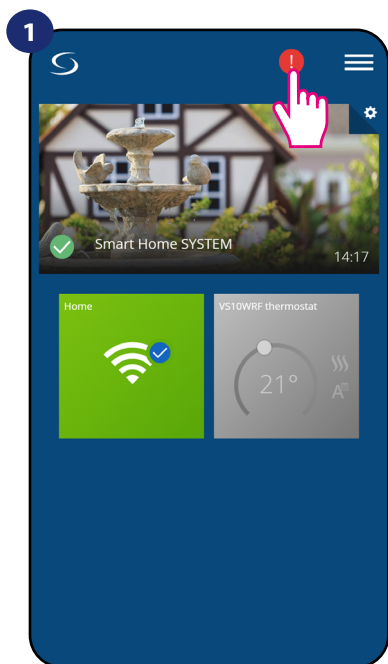

Press the exclamation mark button.

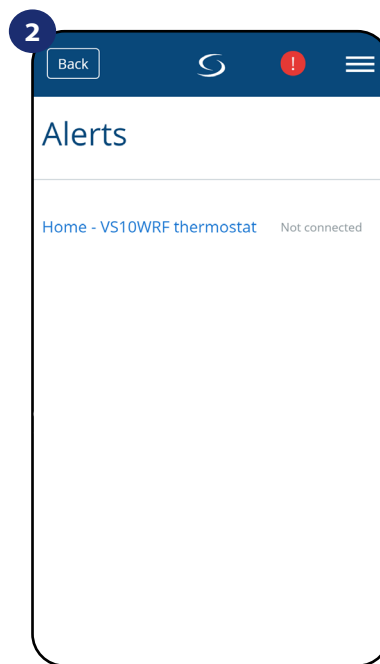

All current errors are displayed.

Errors are visible also on the thermostat's LCD display.

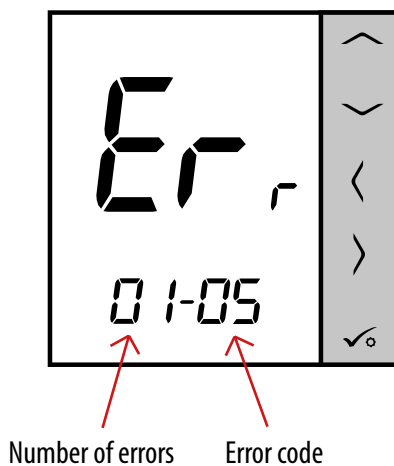

ERR 01-03 (Floor Sensor Defect) means that there is a break in the circuit of the temperature sensor plugged into the S1 / S2 contacts of the thermostat or the sensor has been activated and not connected to the thermostat.

When problem has been solved (sensor change or re-connection in this case) - exclamation mark will disappear in application and thermostat will stop flashing error.



Full list of errors is in chapter 11.

6.12 Wireless signal strength test

Each wireless device has a limited range. Beyond distance there are many more elements which could affect on. For example - concrete walls, other wireless network interferences, wooden walls, reinforced concrete ceilings, metal construction elements, pillars, aluminium foil for underfloor heating etc. Smart Home system has built-in function which allows to check wireless signal quality. If you want to check your system connectivity and signal's strength please follow steps below:



Press the gear icon in upper right corner of the background image.

Select „Scan my home” option.

Here you can check wireless signal quality of given devices.

Signal quality is expressed in **decibel units (db)**. Compare your value with scale below:

-50db to 0db - very good quality signal

-75db to -50db - good quality signal

-85db to -75db - low quality signal

-95db to -85db - bad quality signal, make wireless connection nearly impossible

PLEASE NOTE: Every Smart Home system device which is powered 230VAC is also working as a signal repeater of ZigBee network. If system is based on battery devices there could be a need to use repeaters like Salus RE600, Salus RE10RF or any other device of Salus Smart Home series which is powered by 230V AC.

6.13 Factory reset (removing thermostat from the app and ZigBee network)

To make thermostat factory reset and remove it from the ZigBee network please follow steps below:

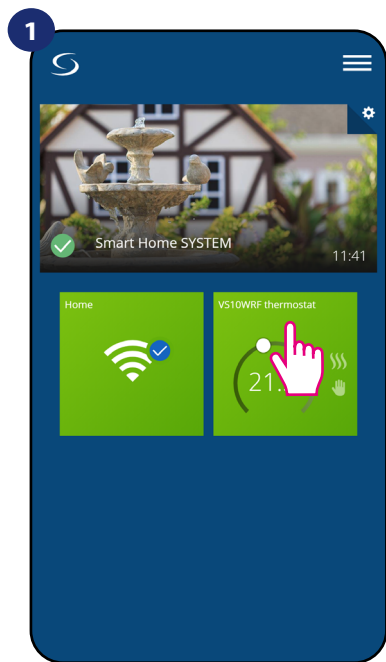

Select the thermostat in the main app menu.

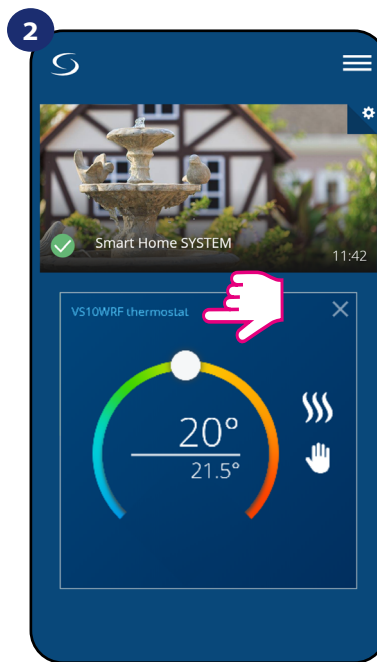

Press thermostat's name.

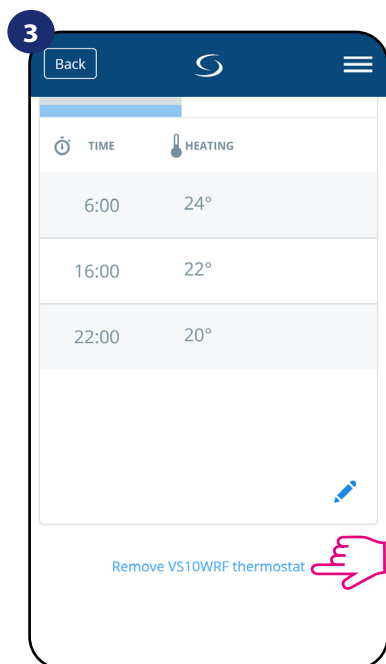

At the very bottom of thermostat's menu choose „Remove” option.

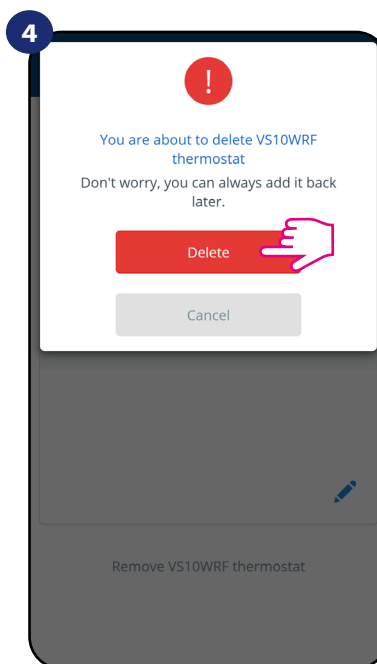

Press „Delete” button to remove your thermostat from the app and confirm factory reset.



NOTE: Factory reset function removes thermostat from the ZigBee network. This means that thermostat is not visible anymore in the „My equipment” list.

You can also do factory reset from the thermostat directly. It will also remove your thermostat from the Zigbee network but you still will be able to see thermostat's tile. After factory reset thermostat tile will change to dark grey colour.

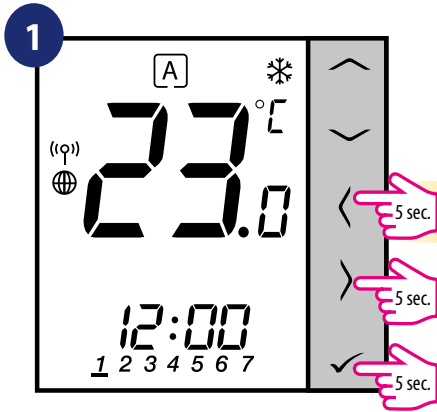

Press ✓ + < + > buttons for 5 seconds to enter the installer mode.

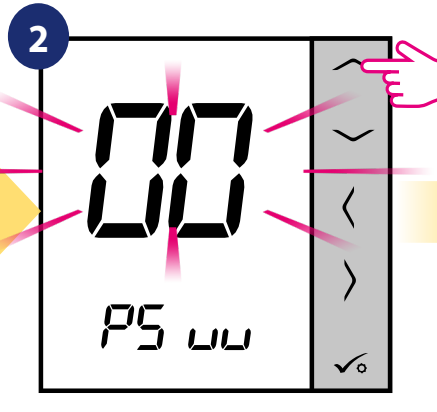

Go to the Admin Settings.

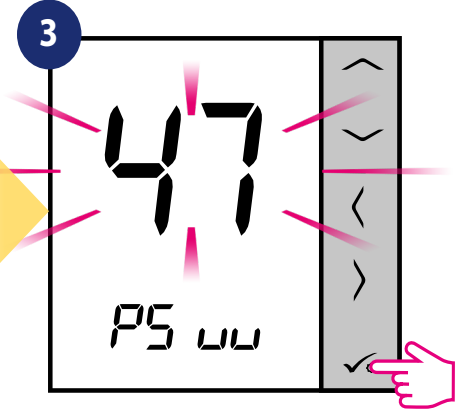

Choose „Factory Reset” option.

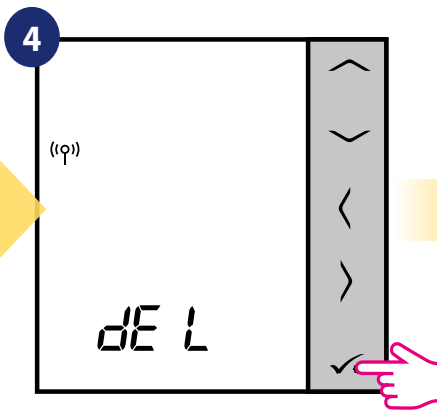

Select „del” and confirm choice by pressing ✓ button.

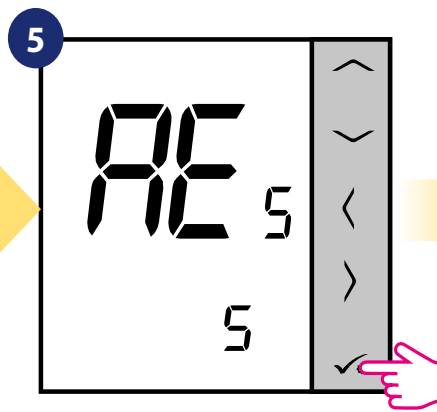

Wait few moments to finish factory reset procedure. Now you can remove thermostat from the app.

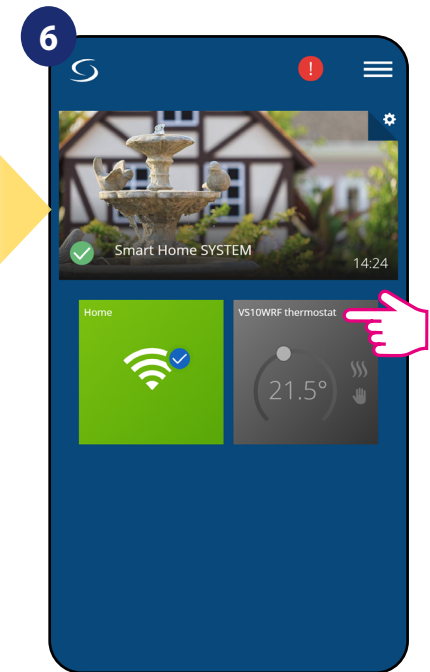

Select the thermostat in the main app menu.

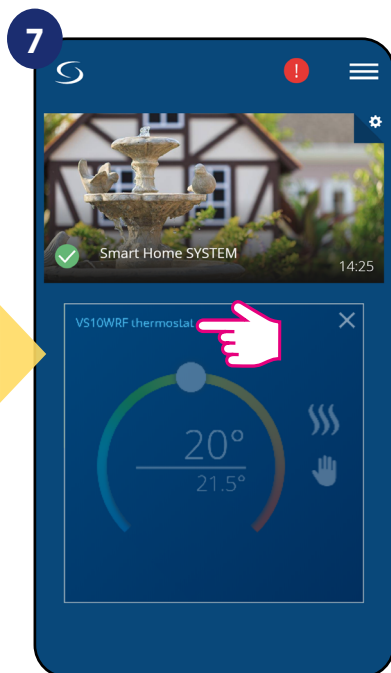

Press thermostat's name.

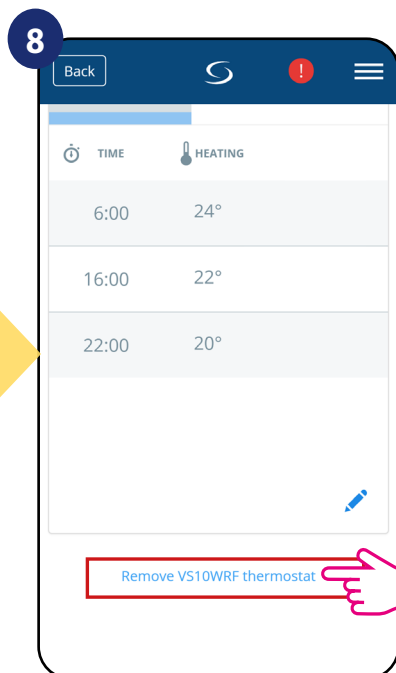

At the very bottom of thermostat's menu choose „Remove” option.

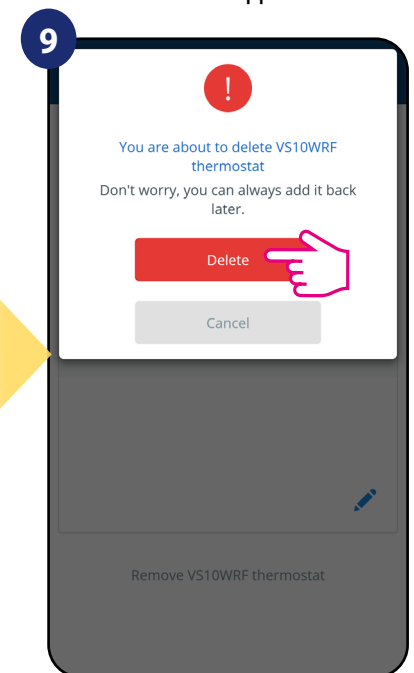

Press „Delete” button to remove your thermostat from the app and confirm factory reset.

7. Installation in OFFLINE MODE without SALUS SmartHome application

7.1 General informations

In **OFFLINE mode** (without application), you can use the **UGE600 Universal Gateway** or **CO10RF coordinator** to configure the system. Please note that you cannot use both devices at the same time. Before installing the system you have to decide:

- to create a network using the **UGE600 Universal Gateway** (you can connect it to the Internet in the future)
- to create a network using the **CO10RF coordinator** (you can't connect it to the Internet)

 **REMEMBER!** The **UGE600 Universal Gateway** and **CO10RF coordinator** are two different devices. Each device creates and operates its own network.

Universal Gateway -

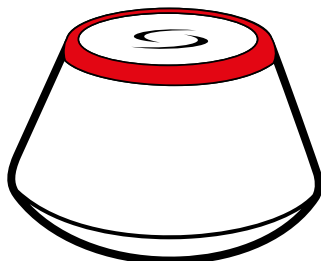

**Universal Gateway is
NOT CONNECTED TO THE INTERNET**

You can use your devices locally without the Smart Home App. Gateway works in this mode as standard ZigBee coordinator.

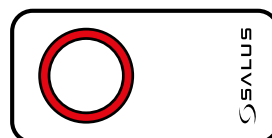

- CO10RF Coordinator

CO10RF Coordinator

You can use standard ZigBee network coordinator to install and use your devices.

NOTE: CO10RF Coordinator is included in the set with the KL08RF Control Box.

 **Please note!** If your system has been installed in the OFFLINE mode using the **UGE600 Universal Gateway** and then connected to the Internet, all devices should be found in the SALUS Smart Home application (using „Scan for equipment“ button). All devices found in the application don't need to be reconfigured, because all settings are automatically copied from the gateway.

Please note! If your system was created using the **CO10RF coordinator** and you would like to control the devices via the Internet, then all devices should be reinstalled using the UGE600 Universal Gateway.



KL08RF - Wiring Centre for 8-zone underfloor heating (UFH).



+ **extension KL04RF**



**TRV
(Thermostatic Radiator Valve)**
- with wireless communication.



RX10RF
receiver

7.2 Pairing with underfloor heating wiring centre (KL08RF/Control Box)

7.2.1 Available operation modes

CASE 1

GROUP 1 - consists of 4 thermostats (in addition, more thermostats can be assigned to a group in further zones located in the wiring centre). Managed by 1 weekly, programmable thermostat, configured as a MASTER (group 1), e.g. VS10WRF. The other 3 thermostats are daily, non-programmable, configured as a SLAVE (group 1), e.g. VS10WRF, VS20WRF or HTRS-RF(30). The MASTER thermostat can affect the SLAVE thermostats (VS10WRF, VS20WRF or HTRS-RF(30)), which will follow the schedule set on the VS10WRF thermostat. Remember - if you want MASTER thermostat to control the SLAVE thermostats, then all SLAVE thermostats have to be set to AUTO mode - [A]. The VS10WRF thermostat is configured as a MASTER or SLAVE thermostat during pairing with the KL08RF underfloor heating wiring centre (see section 7.2.2).

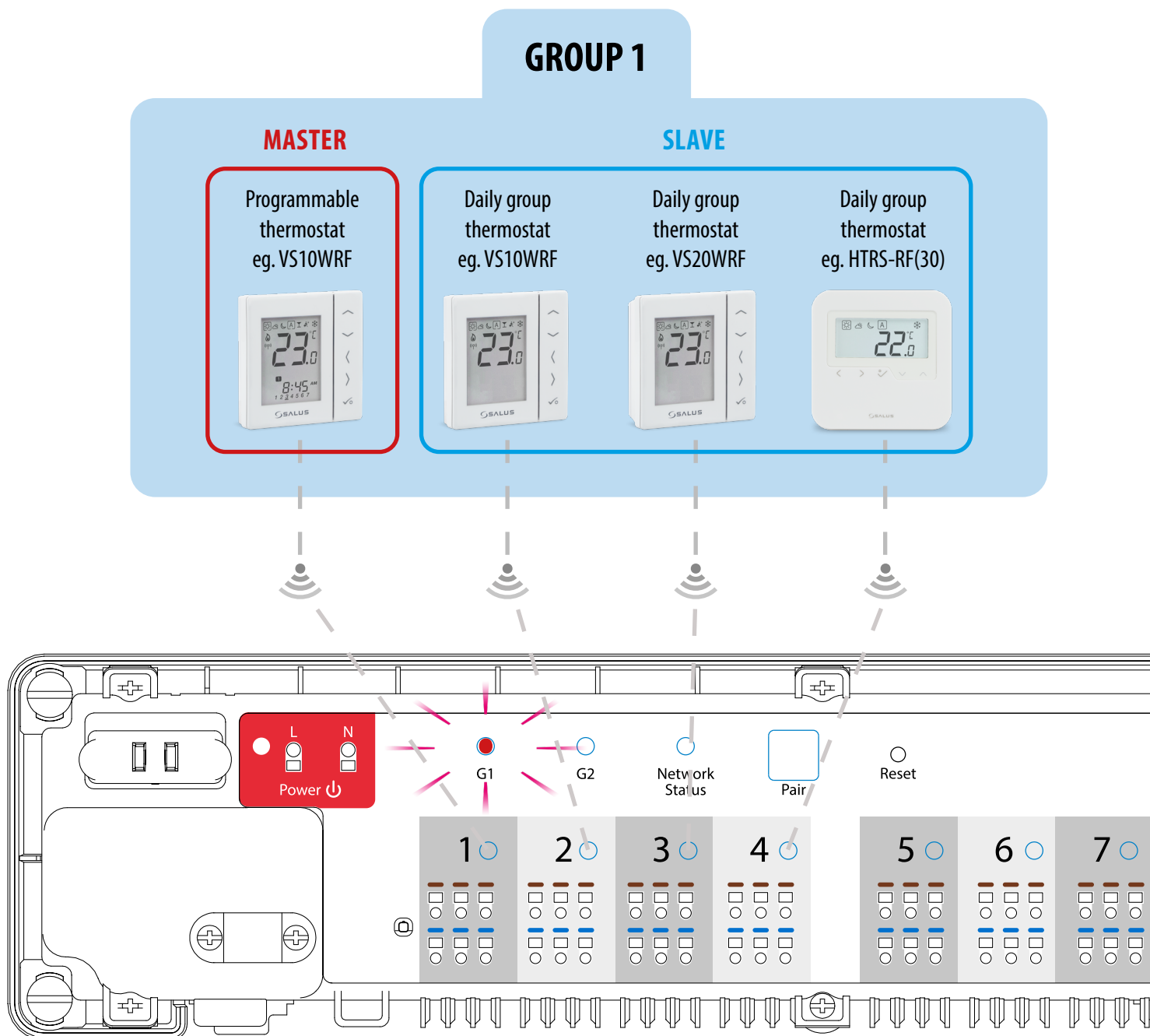

CASE 2

GROUP 2 - consists of 2 thermostats. The first thermostat is a daily, non-programmable thermostat, configured as a SLAVE (group 2), e.g. VS10WRF. The second thermostat is a weekly, programmable thermostat, configured as a MASTER (group 2), e.g. VS10WRF. The MASTER thermostat can affect the SLAVE thermostats (VS10WRF), which will follow the schedule set on the VS10WRF thermostat. Remember - if you want MASTER thermostat to control the SLAVE thermostats, then all SLAVE thermostats have to be set to AUTO mode - [A]. The VS10WRF thermostat is configured as a MASTER or SLAVE thermostat during pairing with the KL08RF underfloor heating wiring centre (see section 7.2.2).

NOTE - you can also create the second group on the same wiring centre. The groups will operate independently of each other.

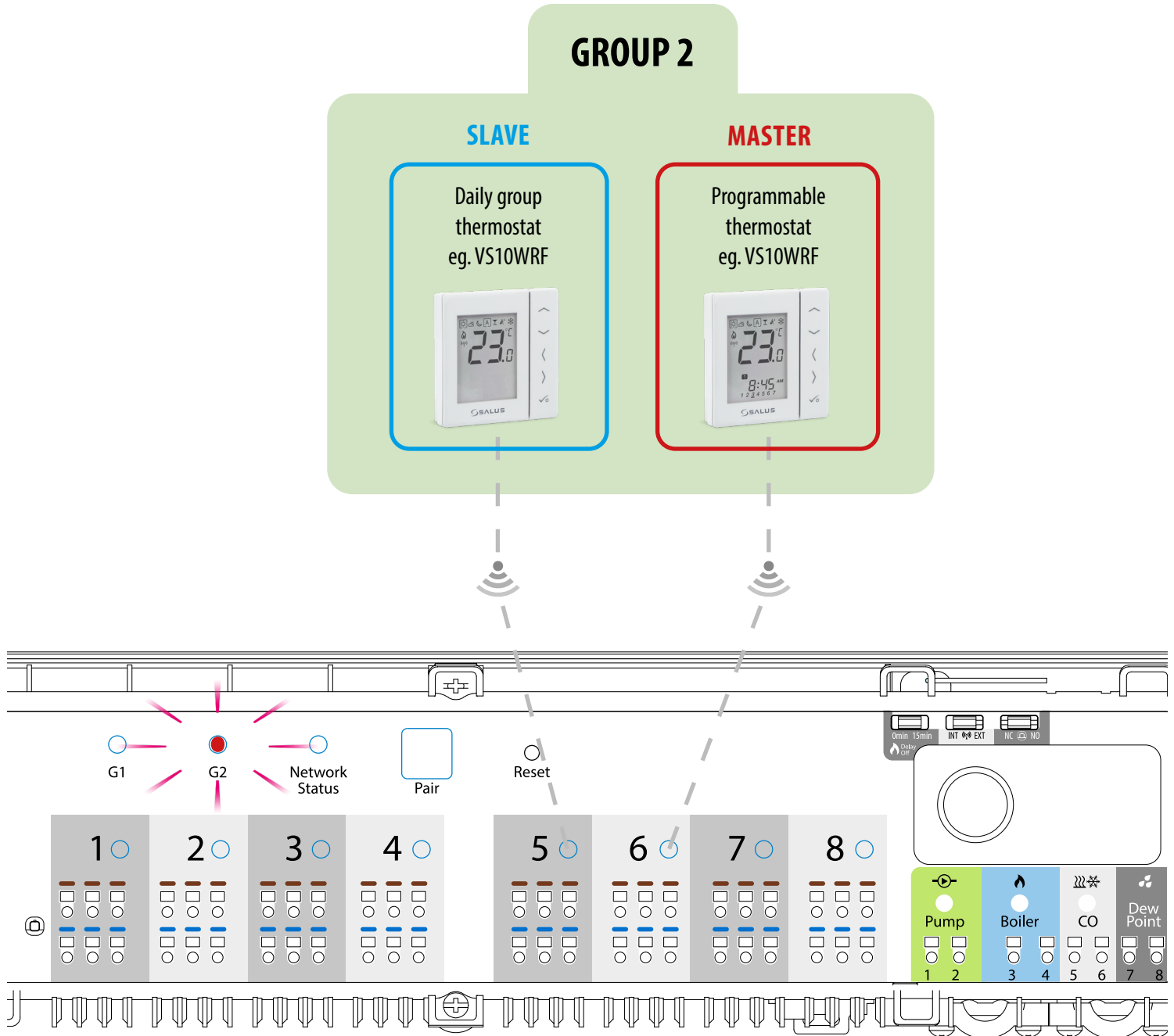

CASE 3

Programmable temperature thermostat - this is a single, independent thermostat assigned to any zone on the wiring centre, configured as a regular weekly, programmable thermostat (not MASTER, not SLAVE). In Offline mode it is possible to set a weekly schedule and the set temperature can be changed automatically according to the time programs. The thermostat's menu allows you to set three predefined temperature setpoints (see chapter 8.1. „Work modes”) that are used as part of the programmable schedule. It also has the ability to work separately in manual mode, not related to the schedule. Configuration of the VS10WRF thermostat as a programmable temperature thermostat occurs during pairing with the KL08RF underfloor heating wiring centre (see section 7.2.3).

Programmable temperature thermostat

Programmable
thermostat
eg. VS10WRF

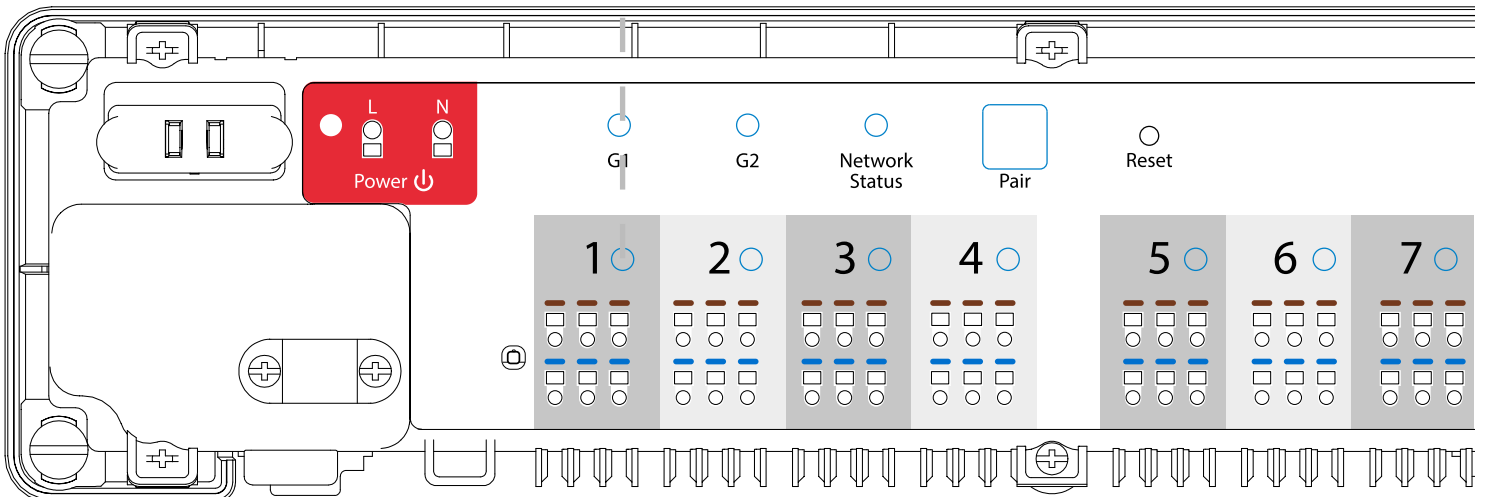

7.2.2 Grouping - installation of the thermostat as a group controller - MASTER - or as a group thermostat (SLAVE)

In this chapter you will learn how to set VS10WRF/VS10BRF thermostat as a group controller (MASTER) or group thermostat (SLAVE). Please look at the instructions below:

VS10WRF/VS10BRF AS A GROUP CONTROLLER (MASTER):

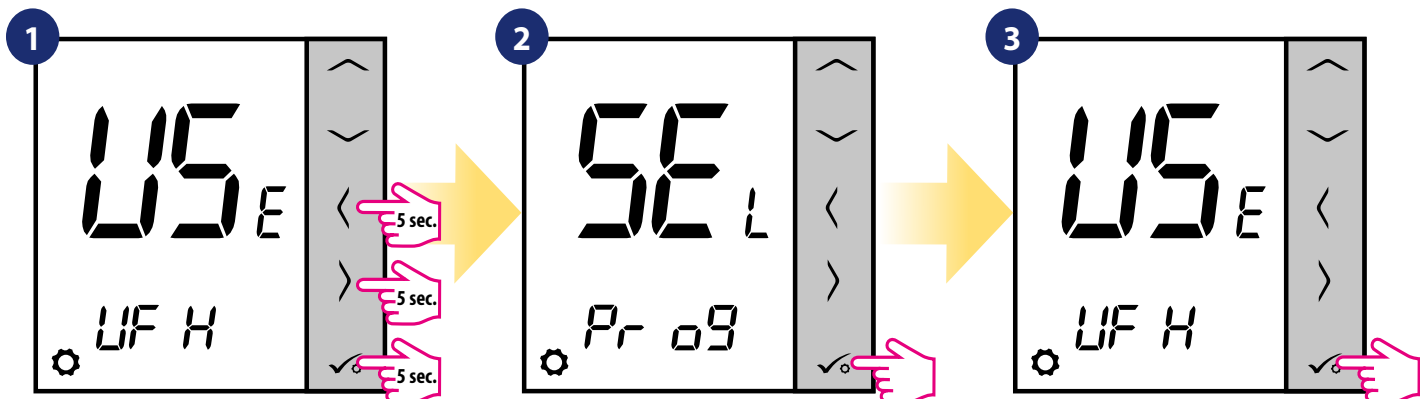

Hold + buttons for 5 seconds to expand menu.

Set thermostat as a programmable and confirm by button.

Set your thermostat for underfloor heating by „” or „” buttons. Confirm by button.

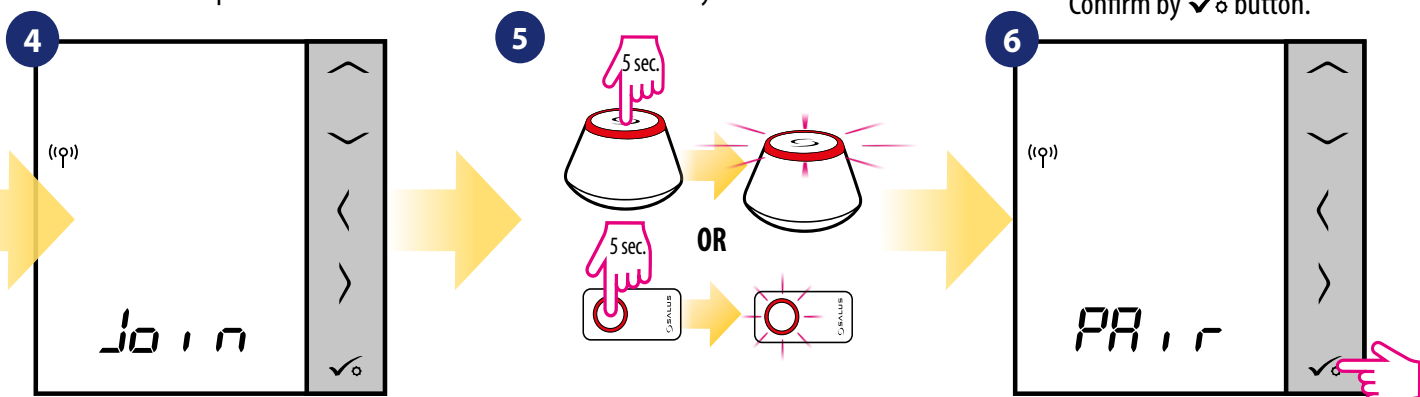

Now thermostat is looking for the signal from the coordinator...

Open the ZigBee network.

Thermostat has caught the signal from the coordinator. Press button to confirm.

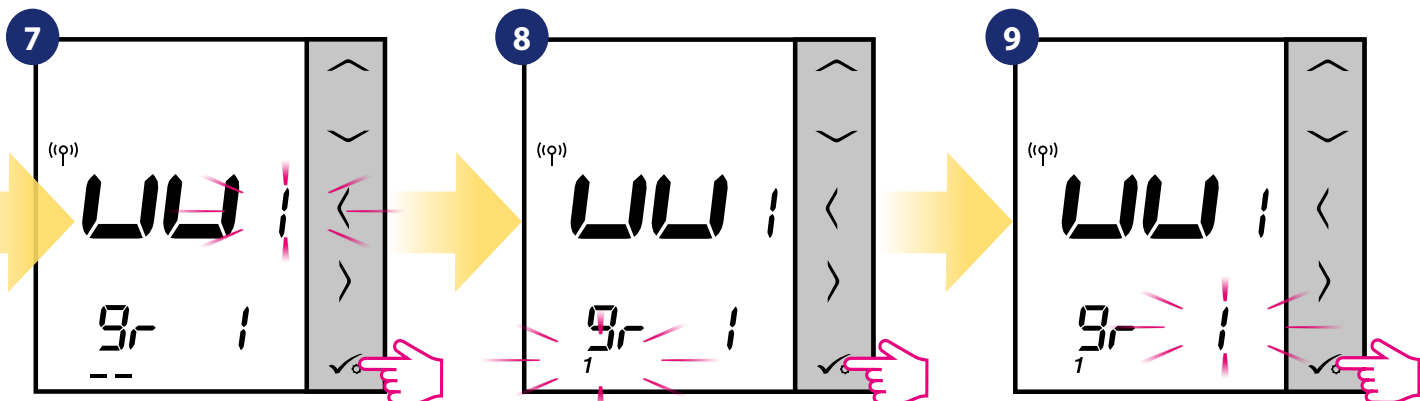

Using and buttons select the KL08RF number (press PAIR button on the KL08RF to see its address number). Press button to confirm.

Use or buttons to set thermostat as a group controller „MASTER” (choose number 1). Confirm by button.

Use or buttons to select the KL08RF zone number and press button to confirm.

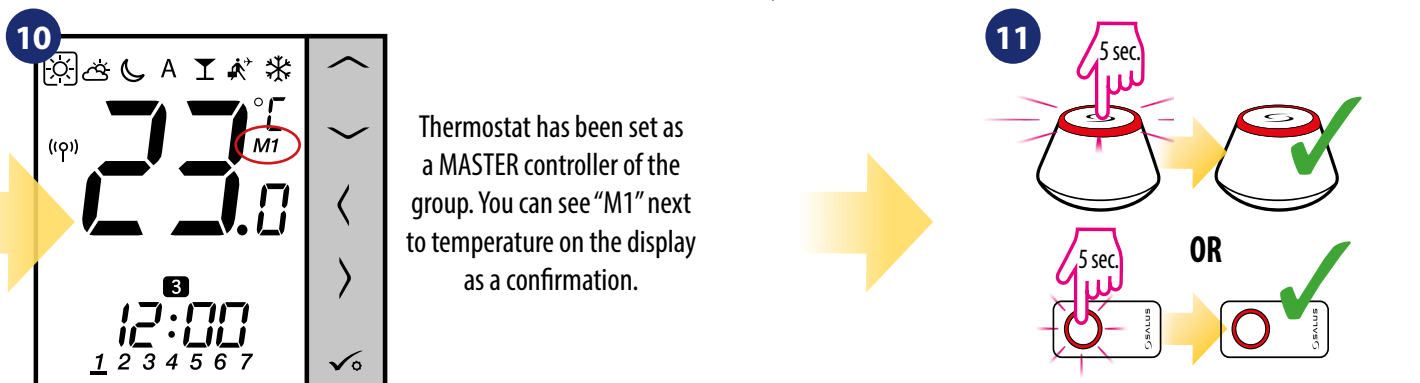

Thermostat has been set as a MASTER controller of the group. You can see “M1” next to temperature on the display as a confirmation.

Close the ZigBee network.

Now you have to set different VS10WRF/VS10BRF as a slave thermostat:

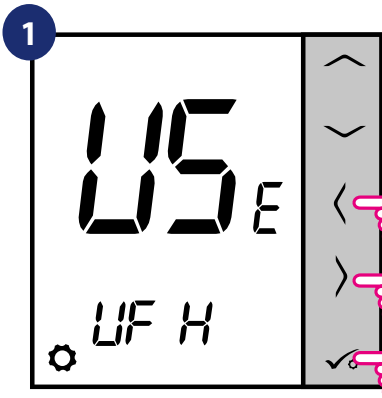

Hold + buttons for 5 seconds to expand menu.

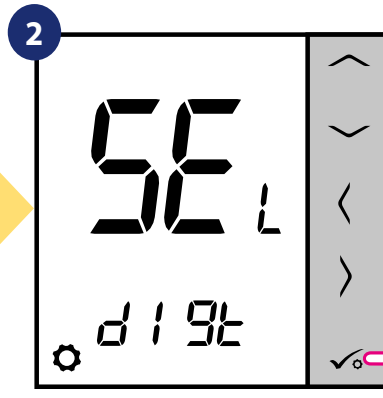

Set thermostat as a non-programmable and confirm by button.

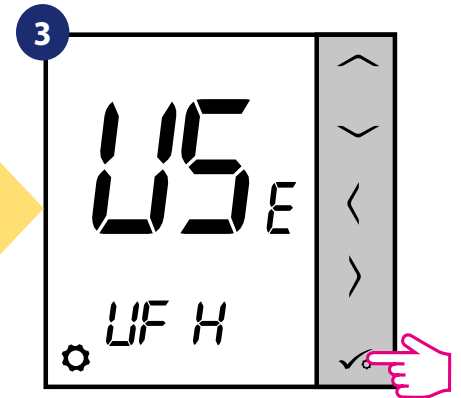

Set your thermostat for underfloor heating by „” or „” buttons. Confirm by button.

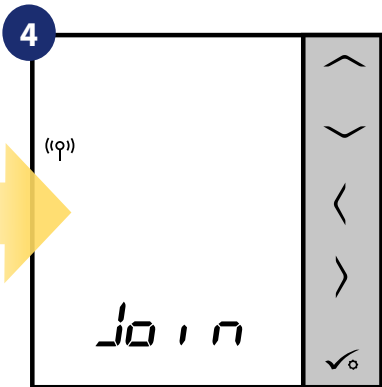

Now thermostat is looking for the signal from the coordinator...

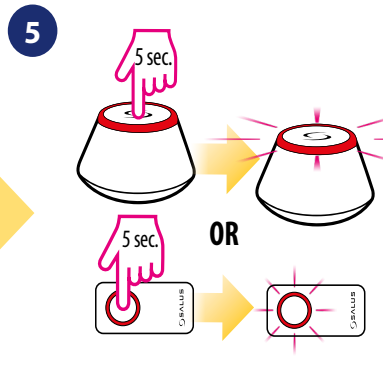

Open the ZigBee network.

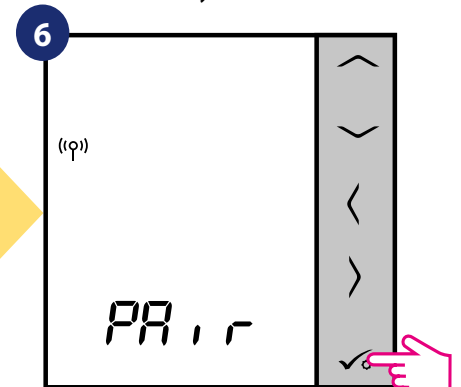

Thermostat has caught the signal from the coordinator. Press button to confirm.

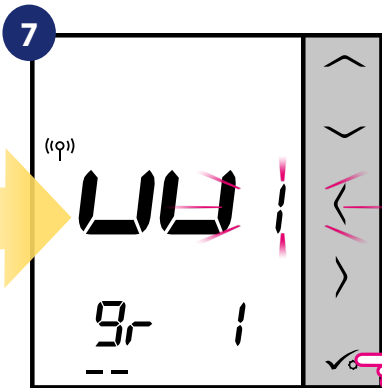

Using and buttons select the KL08RF number (press PAIR button on the KL08RF to see its address number). Press button to confirm.

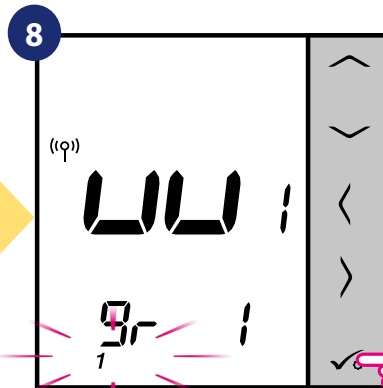

Use or buttons to set thermostat as a group thermostat „SLAVE” (choose number 2). Confirm by button.

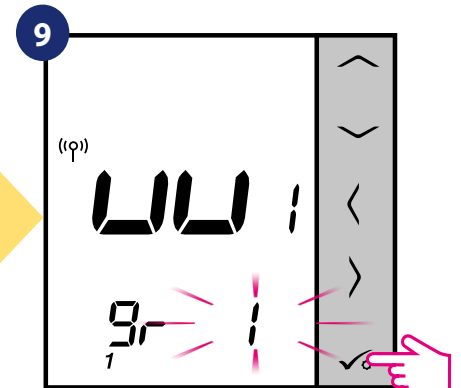

Use or buttons to select the KL08RF zone number and press button to confirm.

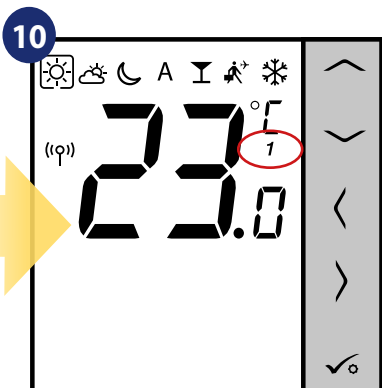

Thermostat has been set as a SLAVE thermostat. You can see “1” next to temperature on the display and lack of clock as a confirmation. Use or buttons and choose - then SLAVE thermostat will follow MASTER group controller.

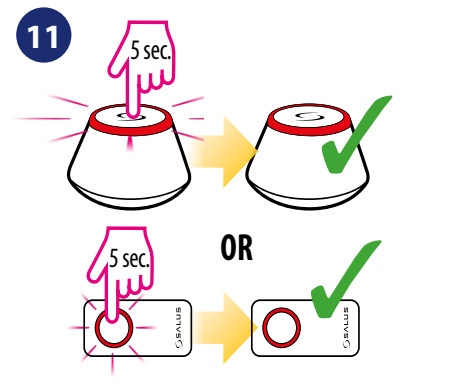

Close the ZigBee network.

7.2.3 Installation as a programmable thermostat

PLEASE NOTE!

For easier installation, please make sure you have already added Underfloor Heating Wiring Centre / Control Box KL08RF to your ZigBee network (please refer to the wiring centre manual instruction).

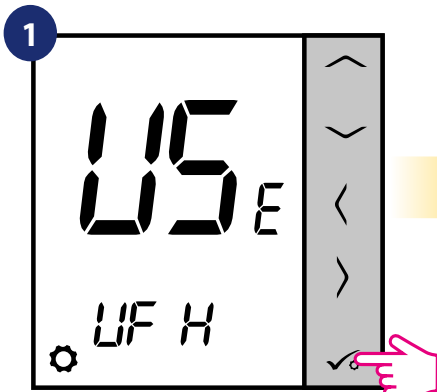

1 Set your thermostat for underfloor heating by "∨" or "∧" buttons. Confirm by ✓ button.

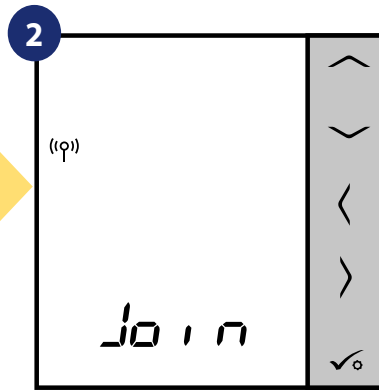

2 Now thermostat is looking for the signal from the coordinator...

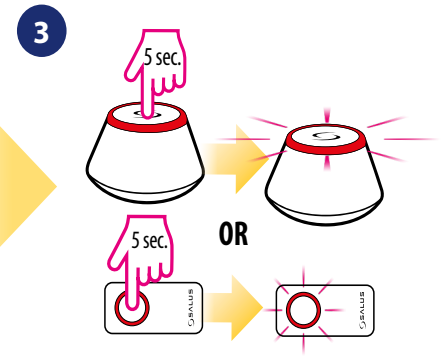

3 Open the ZigBee network.

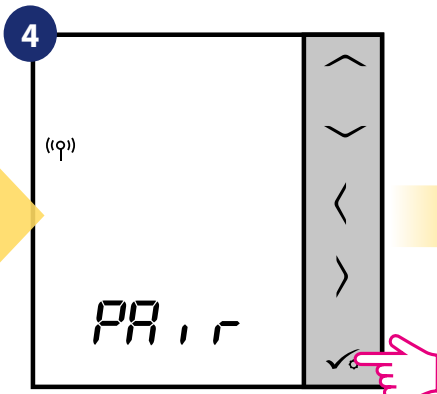

4 Thermostat has caught the signal from the coordinator. Press ✓ button to confirm.

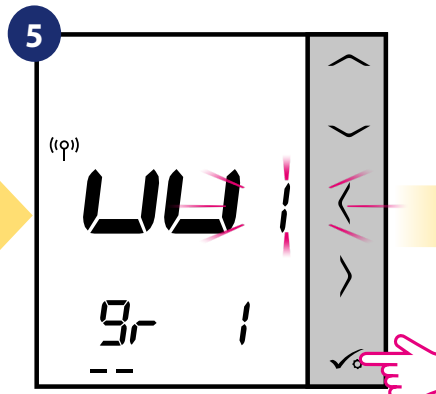

5 Using ∨ and ∧ buttons select the KL08RF number (press PAIR button on the KL08RF to see its address number). Press ✓ button to confirm.

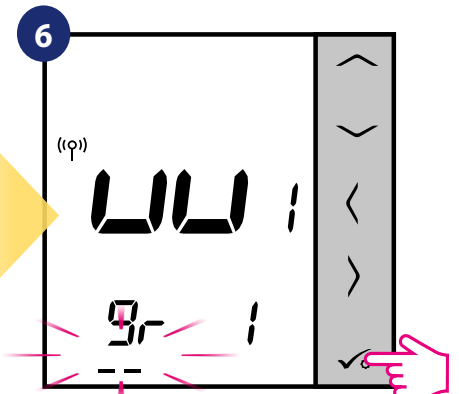

6 Use ∨ or ∧ buttons to group the thermostat in the KL08RF as a one of two areas with 4 zones (8 zones in control box in total 2 areas, without KL04RF extension) and press ✓ button to confirm.

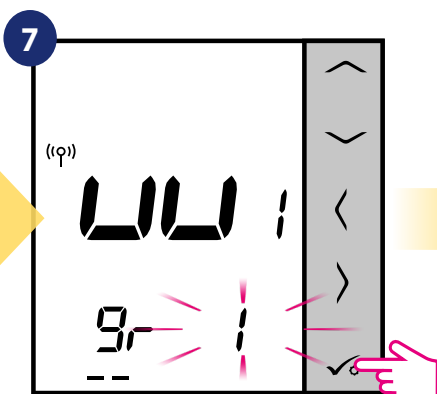

7 Use ∨ or ∧ buttons to select the zone number and press ✓ button to confirm.

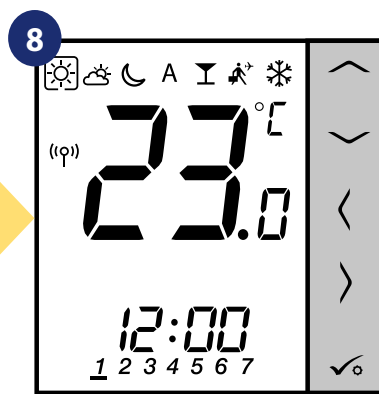

8 When thermostat is successfully paired, main screen will be displayed.

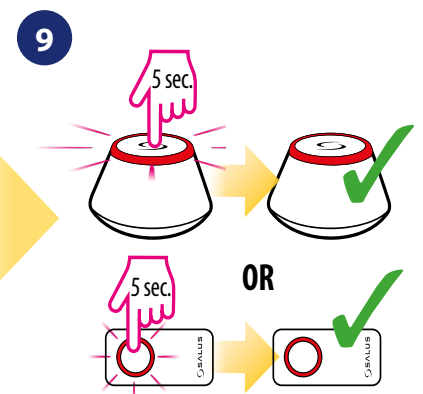

9 Close the ZigBee network.

7.2.4 Replace the zone assigned to another thermostat

You can replace zone on the wiring centre, which is occupied by other thermostat (it will remove it from that zone). To do it follow steps below:

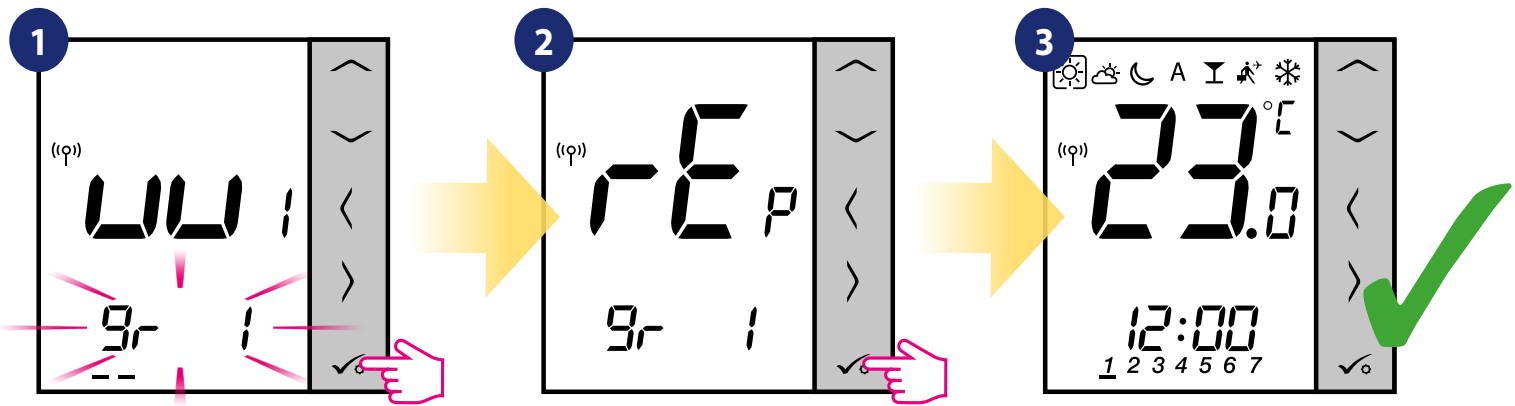

Press ✓ button to confirm zone replacement. You can always change the zone using \vee or \wedge buttons if you don't want to replace it.

Confirm by ✓ button.

When thermostat is successfully paired, main screen will be displayed.

7.3 Pairing with wireless TRV radiator head

PLEASE NOTE!

For easier installation, please make sure you have already added wireless TRV radiator heads to your ZigBee network (please refer to the wireless TRV radiator head manual instruction).

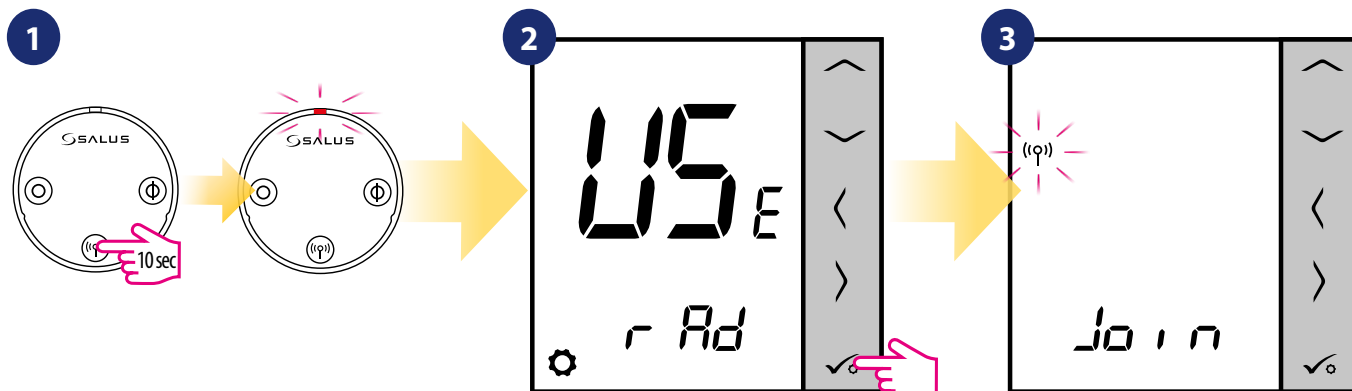

Hold the button ((P)) for 10 seconds,
The LED on the head should start
to blink red. You can pair up to 6 TRV's with 1
thermostat. All TRV's have to be within the
same room with thermostat.

Set your thermostat for radiators
by ∇ or ∇ buttons.
Confirm by \checkmark button.

Now thermostat is looking for the
signal from the coordinator...

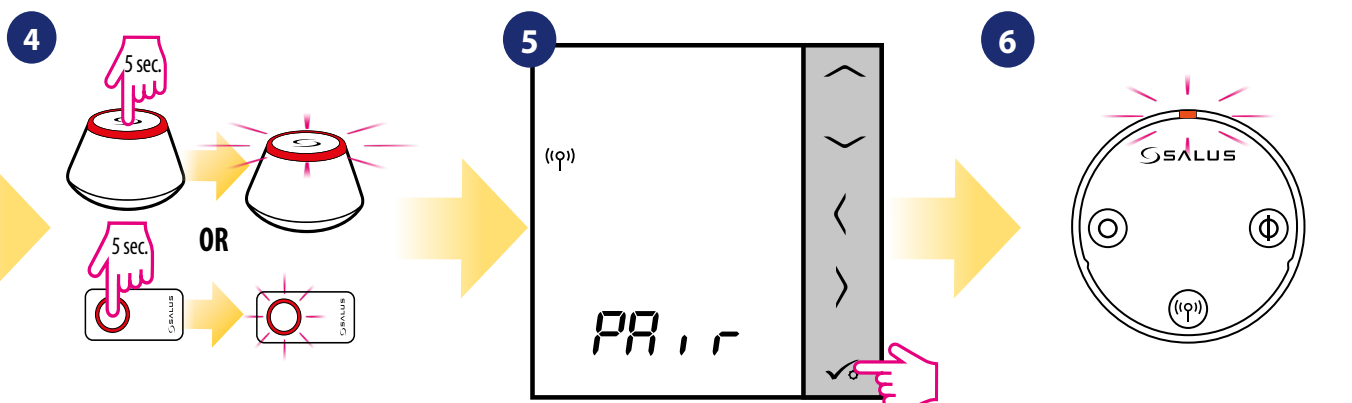

Open the ZigBee network.

The thermostat has been added to
the ZigBee network and paired with
the gateway/coordinator.
Press \checkmark button to confirm.

Device is paired with coordinator,
diode on the TRV will start to blink
orange.

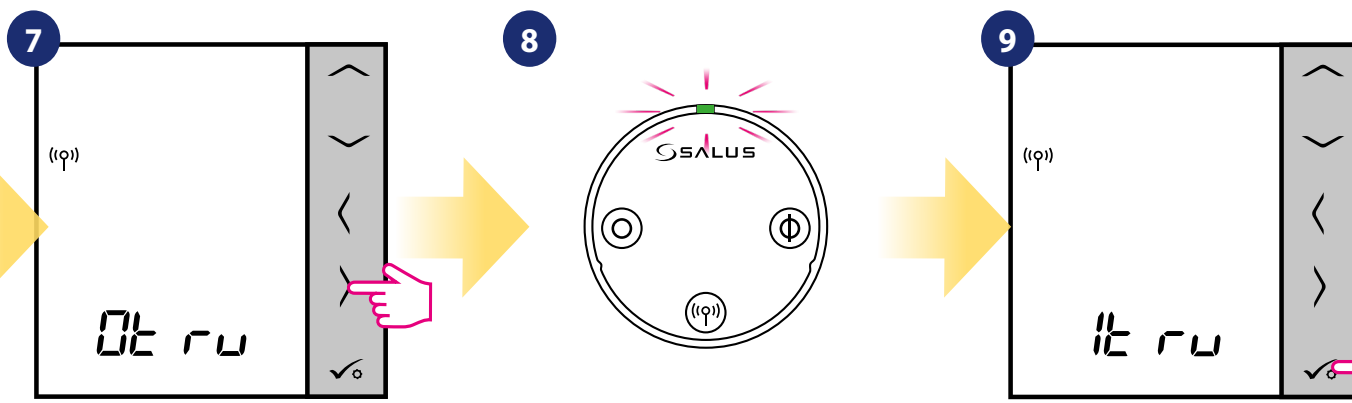

Press $>$ button.
Thermostat is searching for TRV's
radiator heads...

Diode on the TRV will light up once
green and stop blinking.

On the LCD you will see the number of
paired TRV's. Once all TRV's are paired -
press \checkmark button to finish the pairing
process.

10

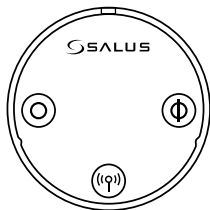

TRV has been added.

11

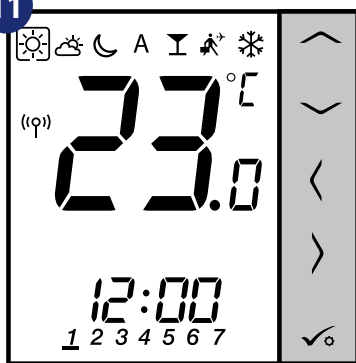

When thermostat is successfully paired main screen will be displayed.

12

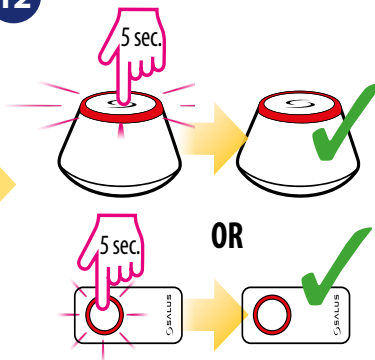

Close the ZigBee network.



7.4 Pairing with RX10RF receiver

PLEASE NOTE!

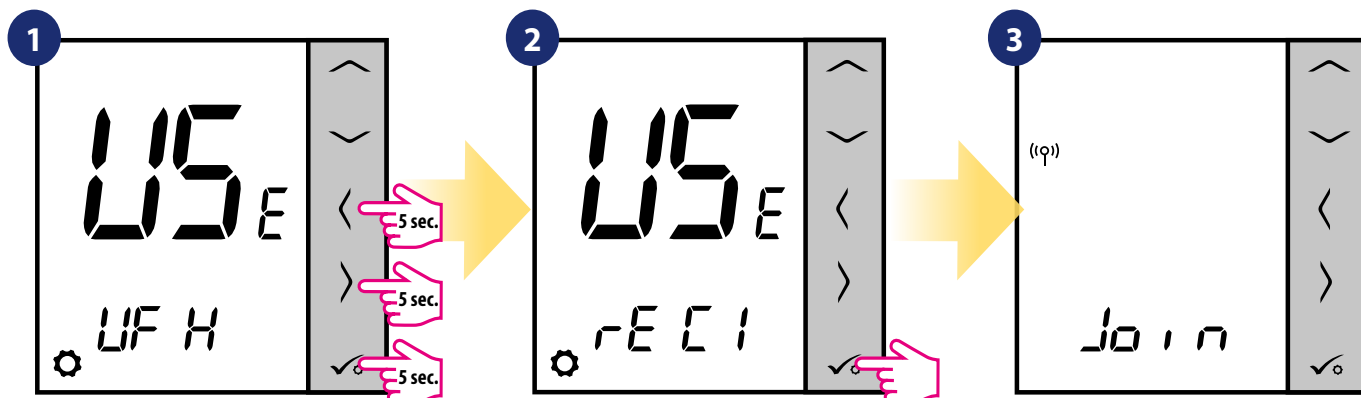
For easier installation, please make sure you have already added RX10RF receiver to your ZigBee network (please refer to the RX10RF receiver manual instruction).



Hold  +  buttons for 5 seconds to expand menu.

Use  or  buttons to:

- choose pairing with the RX10RF receiver in the „RX1” configuration, if the receiver is set as RX1 (receiver responds to the heating signal from any thermostat),
- choose pairing with the RX10RF receiver in the „RX2” configuration, if the receiver is set as RX2 (receiver responds to the heating signal only from one thermostat).

Confirm by  button

Now thermostat is looking for the signal from the coordinator...

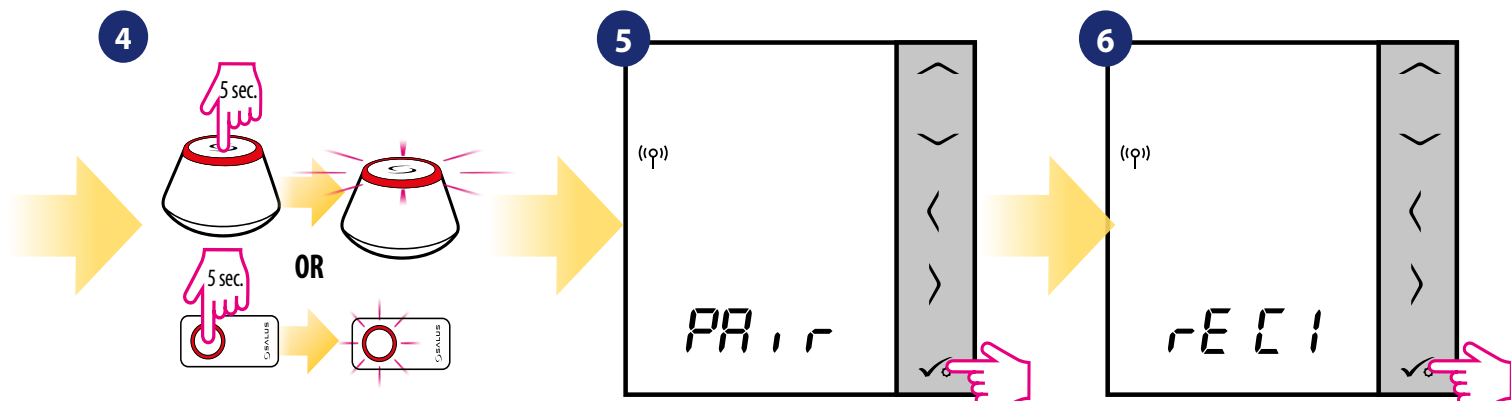

Open the ZigBee network.

Thermostat has caught the signal from the coordinator. Press  button to confirm.

Confirm choice by  button.

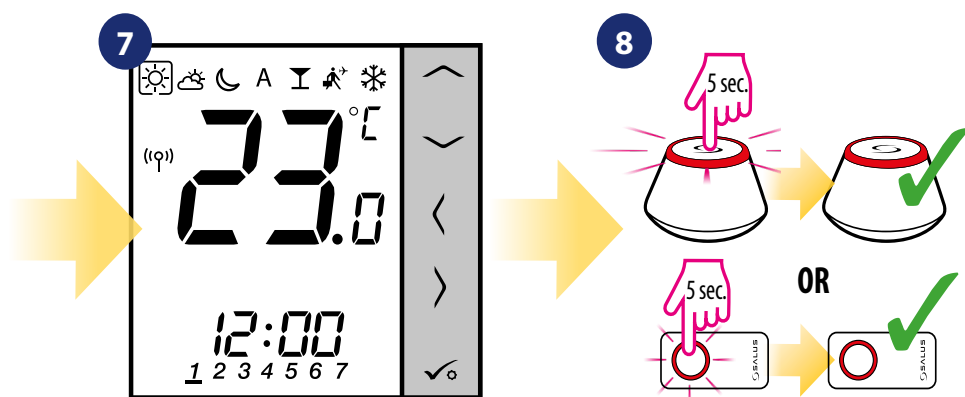

When thermostat is successfully paired main screen will be displayed.

Close the ZigBee network.

7.5 Configuration as a Hot Water timer

7.5.1 Pairing with Room Extension Receiver (RX2)

PLEASE NOTE!

For easier installation, please make sure you have already added other devices to your ZigBee network, such as Underfloor Heating Control Box (KL08RF) or RX10RF.

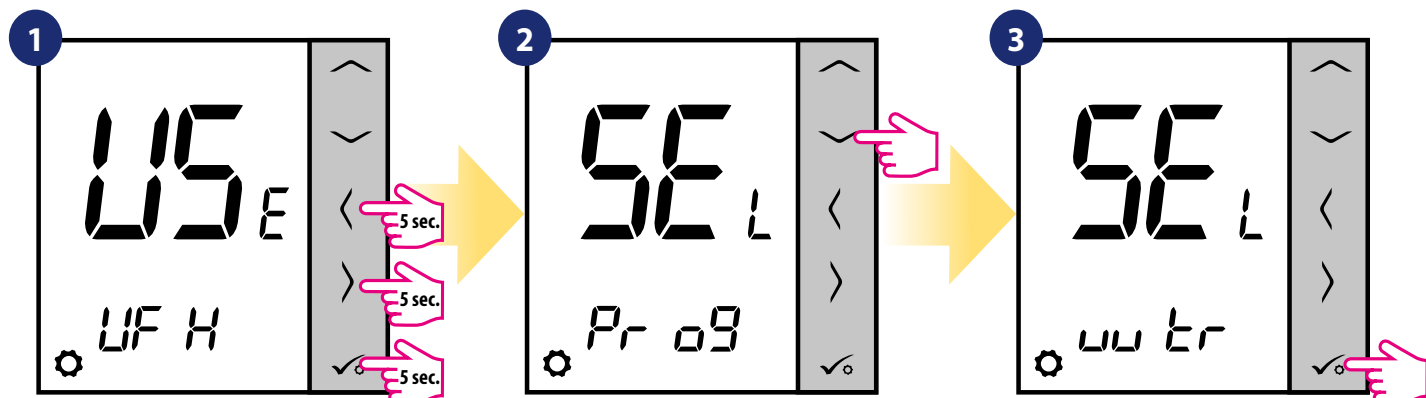

Hold  +  buttons for 5 seconds to expand menu.

Use  or  buttons to move between settings.

Set thermostat as a hot water timer and confirm by  button.

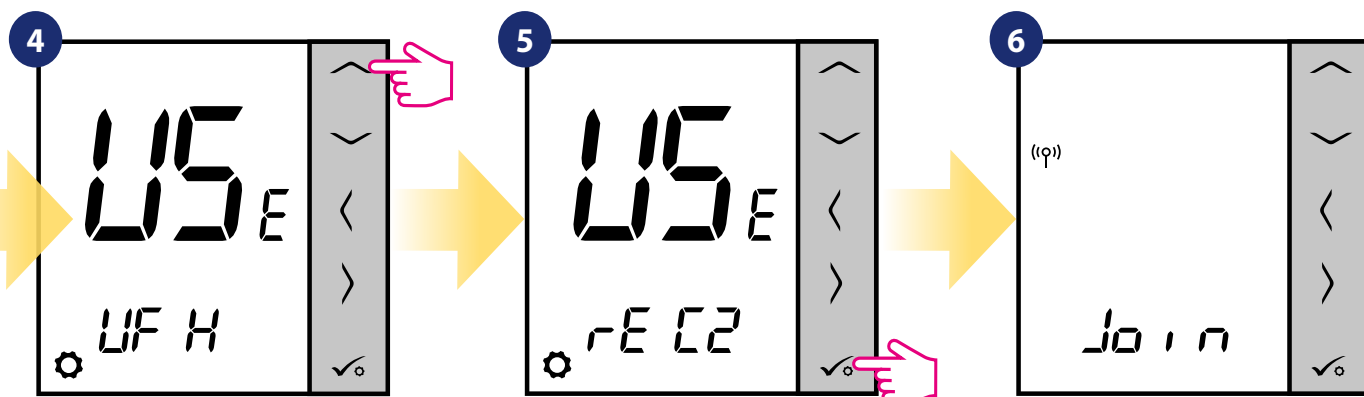

Use  or  buttons to move between settings.

Pair thermostat with RX10RF receiver as an RX2 option. Confirm by  button.

Now thermostat is looking for the signal from the coordinator...

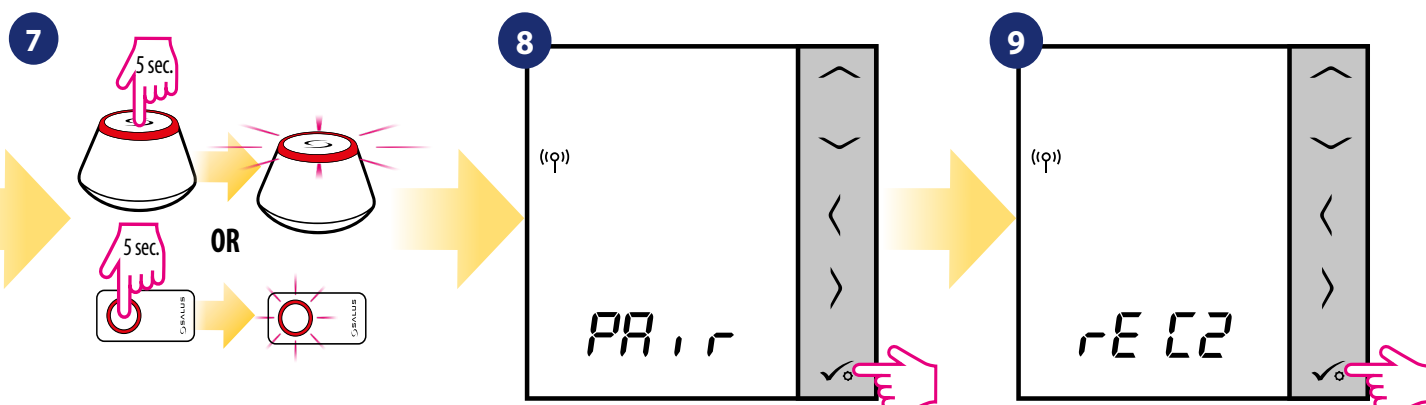

Open the ZigBee network.

Thermostat has caught the signal from the coordinator. Press  button to confirm.

Confirm by  button.

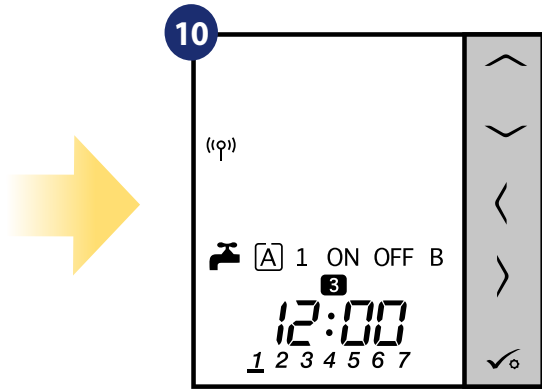

When thermostat is successfully paired main screen will be displayed.

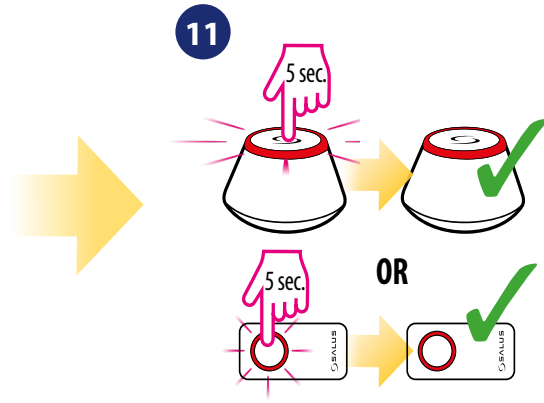

Close the ZigBee network.

8. OPERATING in OFFLINE MODE

8.1 Work as a programmable thermostat

8.1.1 Work modes

VS10WRF/VS10BRF offers few work modes. Frame on a given icon indicates which mode is currently active. In manual mode ☀️, ☁️ or 🌙 only one temperature level is maintained. Thermostat follows programmed schedule when AUTO mode is active („A” icon). Detailed description of work modes is located below:

☀️ - **Comfort temperature mode** - pre-defined setpoint temperature. Usually set when we are indoors. The highest maintained temperature in heating mode or the lowest if thermostat works in the cooling system. Acting alone works as a manual mode.

☁️ - **Standard temperature mode** - pre-defined setpoint temperature. Usually set during the day when we are around the house. Acting alone works as a manual mode.

🌙 - **Economic temperature mode** - pre-defined setpoint temperature. Usually set at night or when we are out of the house. Acting alone works as a manual mode.

A - **Automatic mode temperature (schedule)** - follows programmed schedule. Schedule can be temporarily override with new setpoint temperature (temporary override mode will be active to the next change forced by schedule, 🤲 hand icon will be displayed).

🏠 - **Party mode** - this mode sets the comfort temperature ☀️ for a user-defined time (maximum 9 hours 50 minutes).

🚶 - **Holiday mode** - this mode sets the frost protection mode ❄️ for a user-defined time (maximum 99 days).

❄️ - **Frost protection mode** - usually used during extended periods of absence or during the holidays (only available in heating mode).

Example - comfort temperature mode setpoint editing:

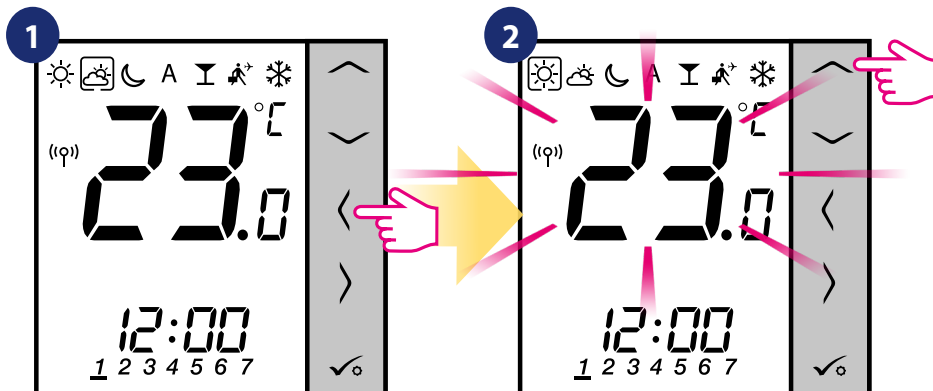

Use < or > buttons to switch between work modes.

Use ∨ or ∨ buttons set temperature setpoint.

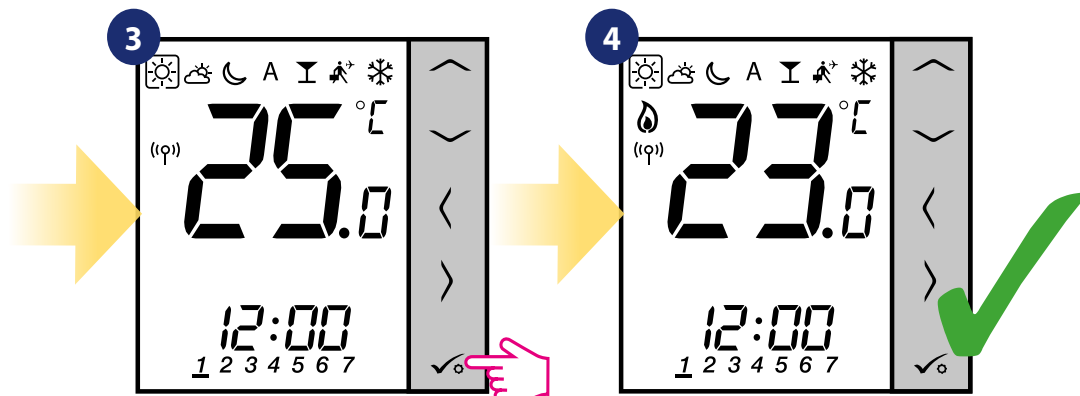

Confirm by ✓ button.

Thermostat will go back to the main screen after saving the settings.

8.1.2 Heat/cool mode change (KL08RF connection)

VS10WRF/VS10BRF thermostat is designed to work in heating and cooling systems. By default thermostat is set to heating mode. To change from heating to cooling mode it's necessary to insert jumper into „CO” terminal (KL08RF wiring centre). Look at the instructions below:

HEATING MODE:

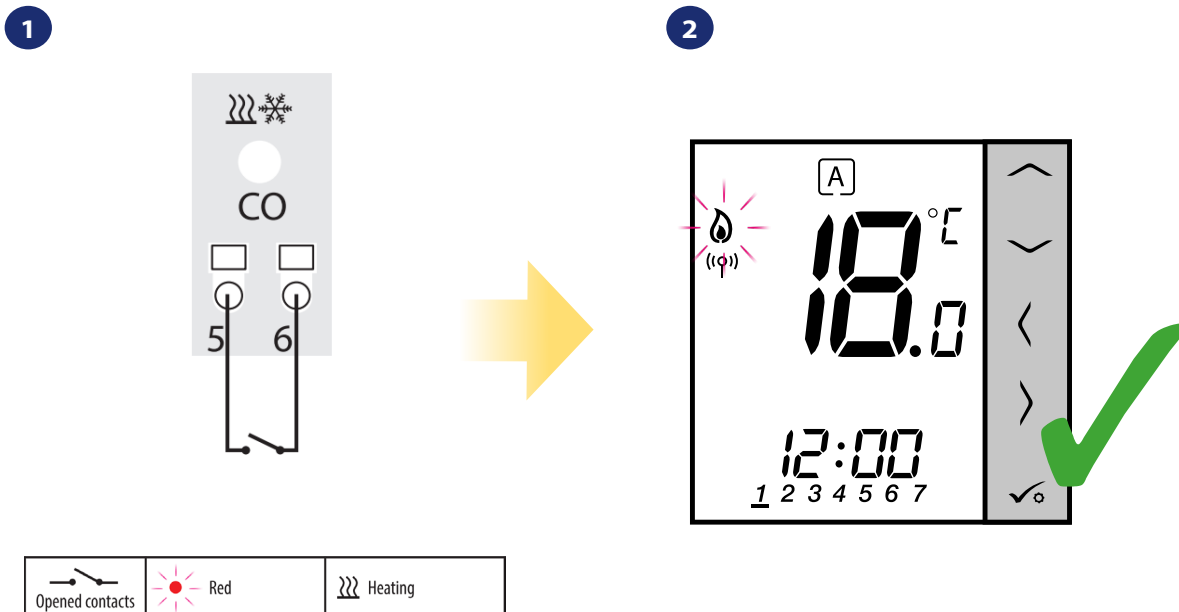

„CO” terminal of the KL08RF wiring centre - if contacts are opened, then all thermostats paired with KL08RF are in heating mode.

When thermostat is calling for heating, then flame icon is displayed.

COOLING MODE:

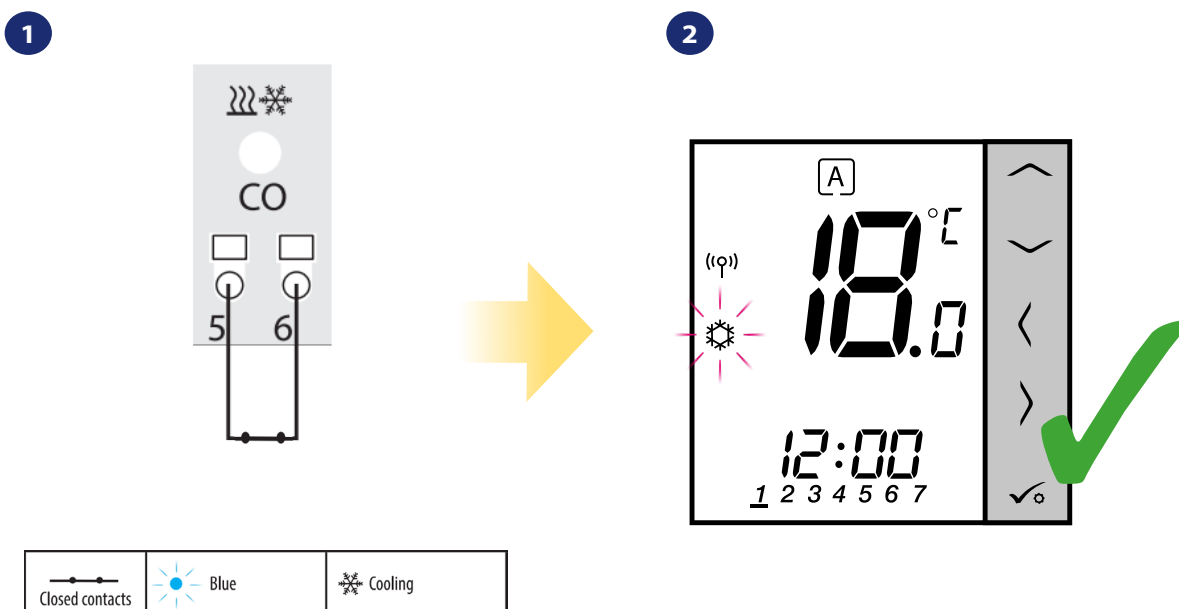

„CO” terminal of the KL08RF wiring centre - if contacts are closed, then all thermostats paired with KL08RF are in cooling mode.

When thermostat is calling for cooling, then snowflake icon is displayed.

8.2 Work as a hot water timer with RX10RF receiver

8.2.1 Work modes

VS10WRF/VS10BRF thermostat as a Hot Water timer has 4 modes available:

- ON - **Turned ON** - thermostat is manually turned on and work as long as you change this mode to another or switch it off,
- A - **AUTO mode** - thermostat is following schedule which you programmed - look at chapter 8.4.1 Schedule mode, page 65,
- OFF - **Turned OFF** - thermostat is manually turned off as long as you select other mode,
- B - **Temporarily ON mode** - you can fast set the water heating time in this mode in limited hour period (from 1 to 4 hours - 1).

Example - setting the „Turned ON” mode:

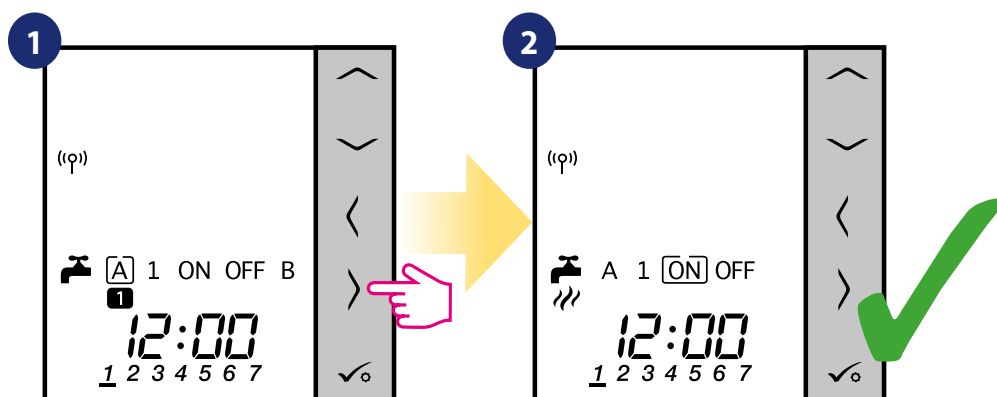

Use < or > buttons to switch between work modes.

Thermostat has been set to the selected mode.

8.3 User settings (basic settings)

8.3.1 Schedule mode - programming schedule

To program schedule in offline mode please follow steps below:

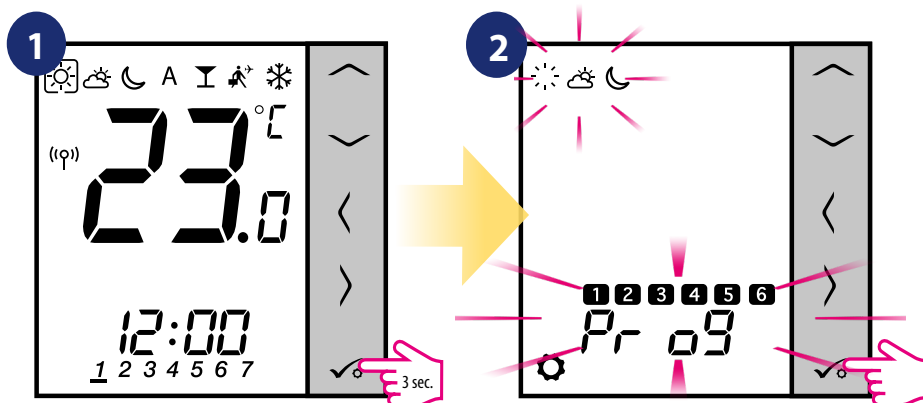

Hold ✓ button for 3 seconds to enter the menu.

Enter into the schedule settings.

3 There are 4 possible schedule variants. Use < and > buttons to select schedule variant and confirm by ✓ button:

Separate schedule for **WORKING DAYS**.

Separate schedule for **WEEKENDS**.

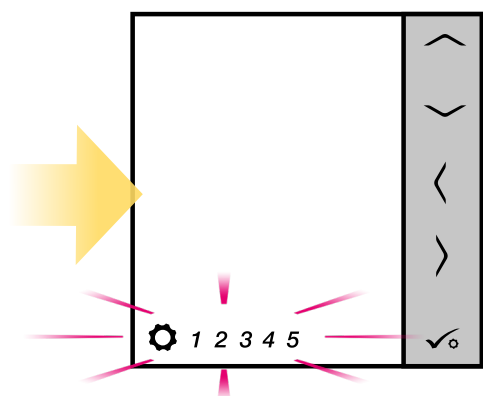

One schedule for **WHOLE WEEK**

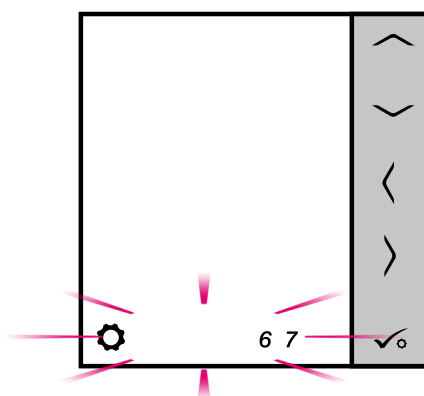

Seven separate schedules for **SINGLE DAYS**

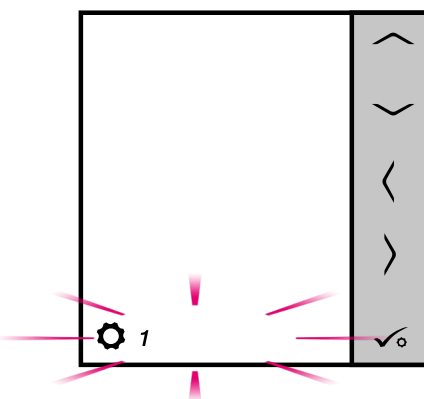
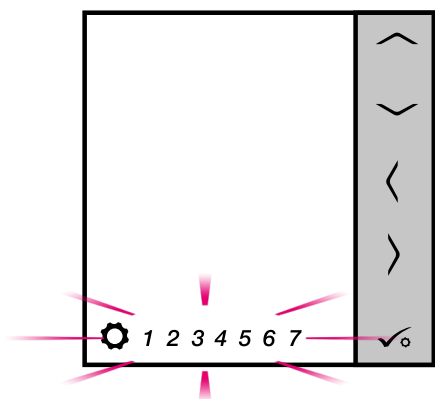

Schedule programming example for the WORKING DAYS variant:

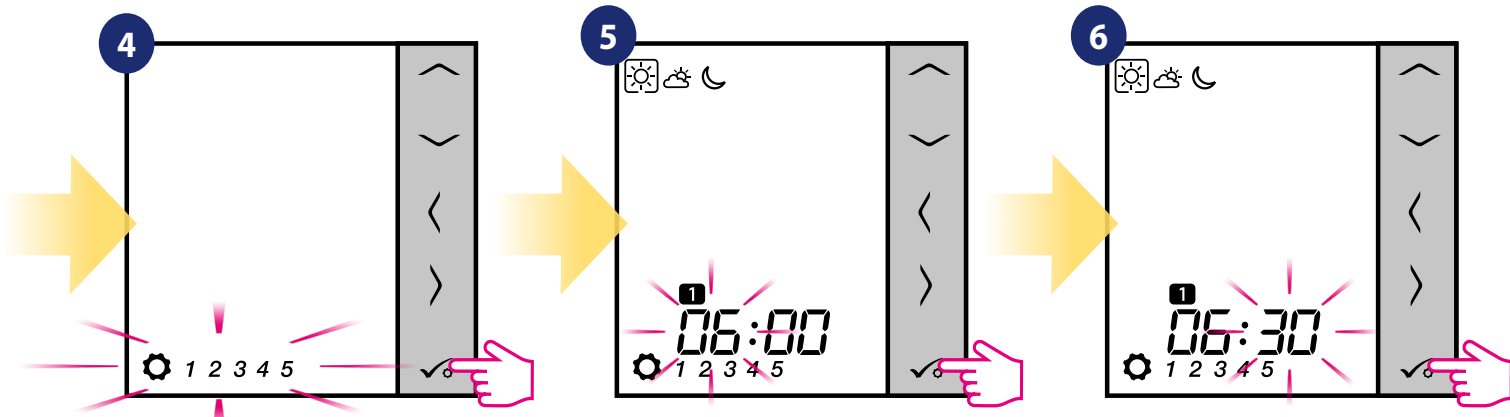

Select schedule variant by ✓ button.

Use ∨ or ∧ buttons to set hour.
Confirm by ✓ button.

Use ∨ or ∧ buttons to set minutes.
Confirm by ✓ button.

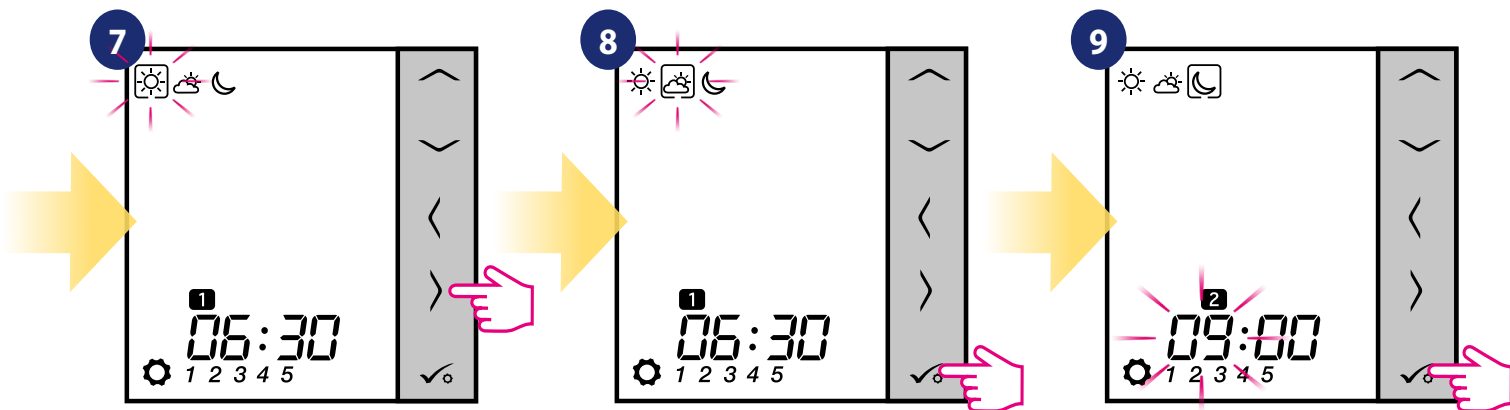

Use < and > buttons to choose comfort, standard or economic setpoint temperature.

Confirm by ✓ button.

Schedule editing will jump to the next program's time setting. Set time for selected mode using ∨ or ∧ buttons again. Confirm by ✓ button.

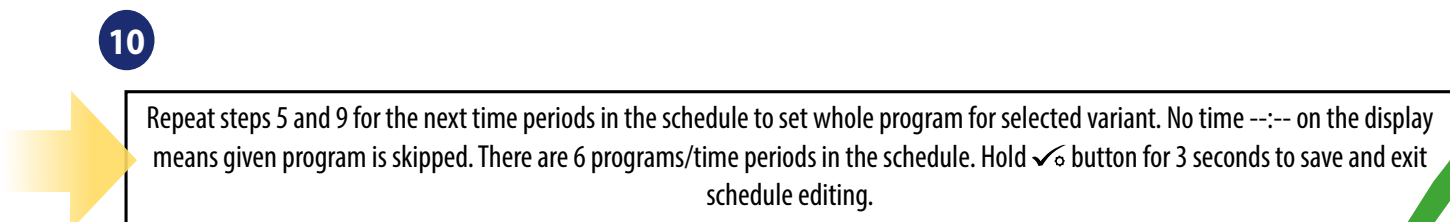

To run the schedule (activate thermostat's automatic mode), use < and > buttons to move the frame to the „A” icon.

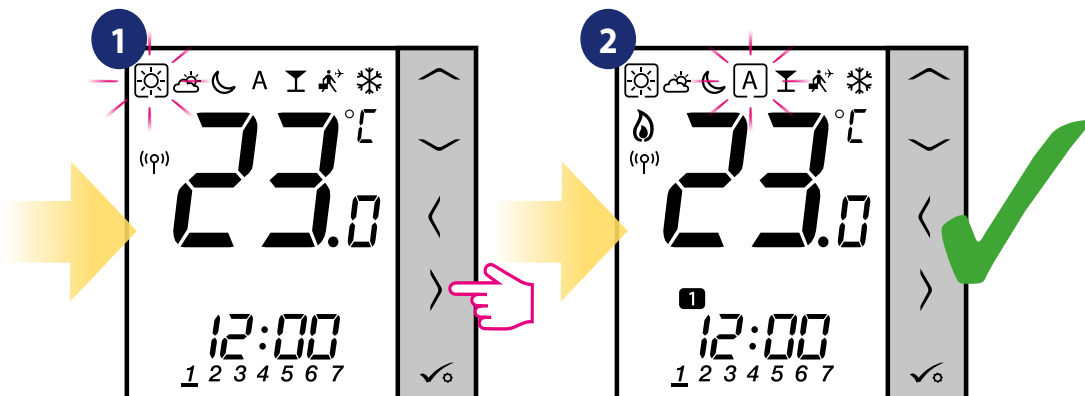

8.3.2 Time/Date

Time/date change or edit can be done **only in Offline mode**. In **Online Mode** thermostat will synchronise **current** time and date based on information taken from the Internet. To set time/date follow steps below:

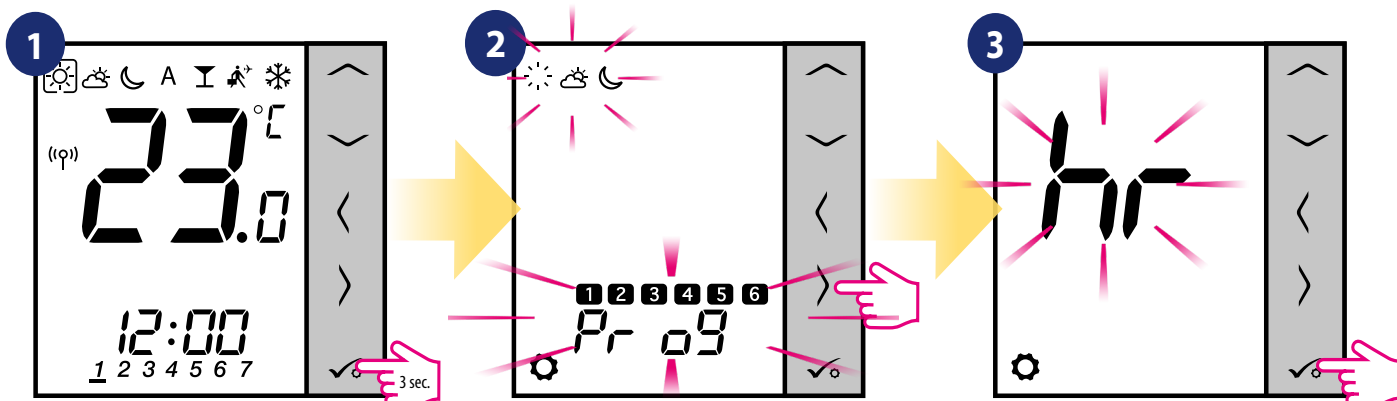

Hold ✓ button for 3 seconds to enter the menu.

Go to the time and date settings using > button. Confirm by ✓ button.

Choose time and date settings option by ✓ button.

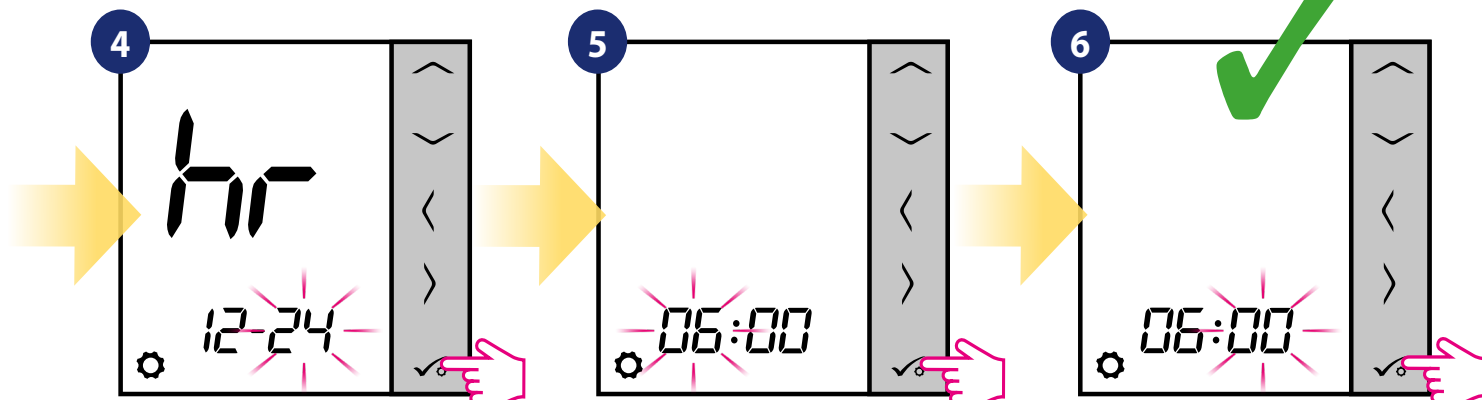

First, select time format (12/24h) using < and > buttons. Confirm by ✓ button.

Set hour using ∨ and ∧ buttons. Confirm by ✓ button.

Set minutes using ∨ and ∧ buttons. Confirm by ✓ button.

DATE settings will automatically appear after clock setup:

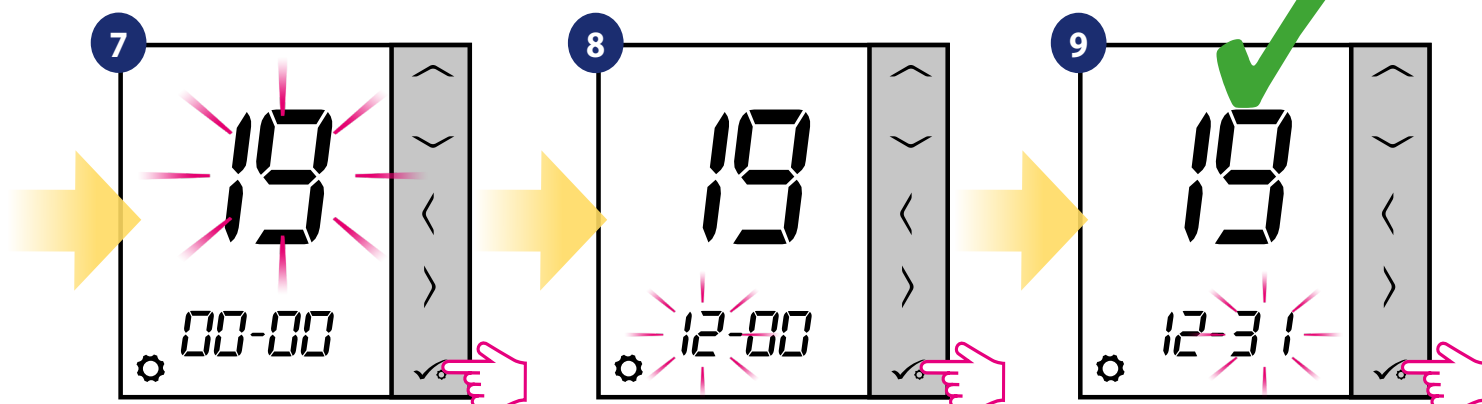

Set year using ∨ and ∧ buttons. Confirm by ✓ button.

Set month using ∨ and ∧ buttons. Confirm by ✓ button.

Set day using ∨ and ∧ buttons. Confirm by ✓ button.

8.3.3 Thermostat calibration

Thermostat calibration is a function which allows user to recalibrate internal thermostat's temperature sensor by a given number of degrees (in the range from -3,0 °C to 3,0 °C in 0,5 °C steps). To calibrate thermostat's temperature sensor please follow steps below:

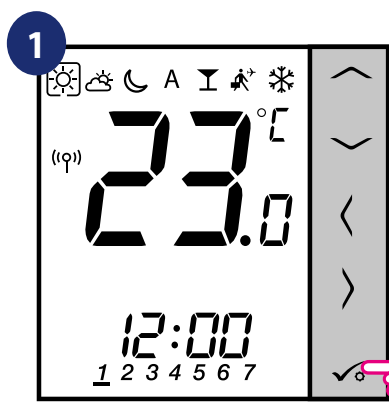

Hold ✓ button for 3 seconds to enter the menu.

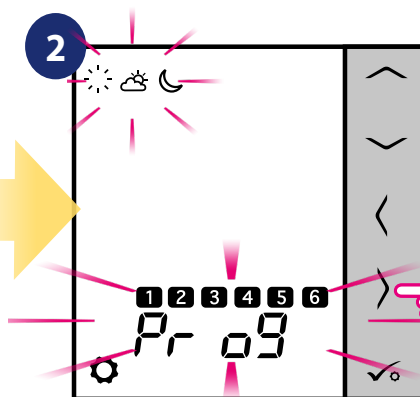

Go to the thermostat calibration settings using > button.

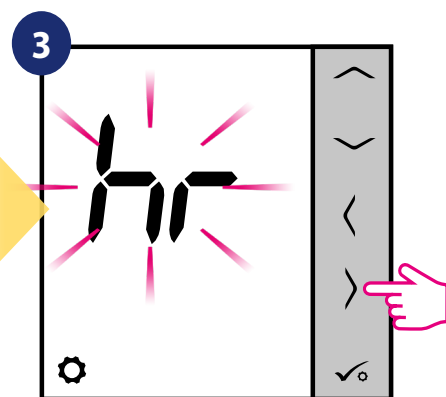

Move forward using > button.

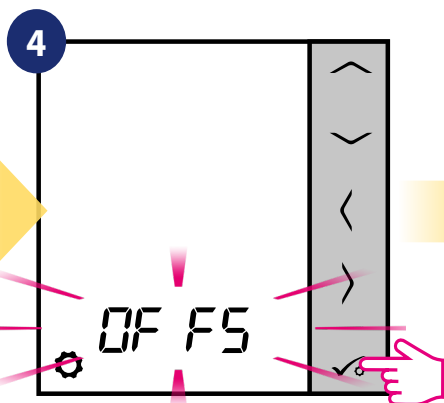

Confirm by ✓ button.

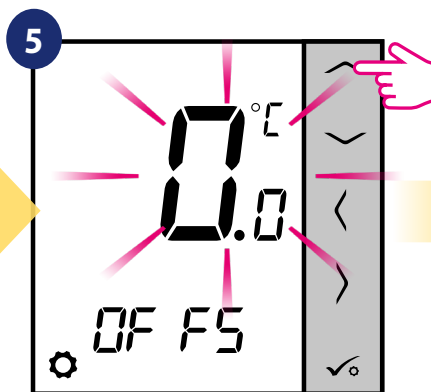

Set temperature calibration value using ✓ and ^ buttons.

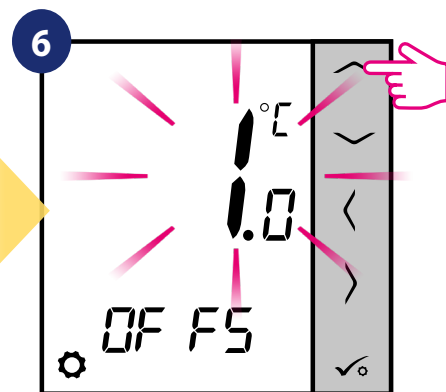

To increase/decrease value use ✓ and ^ buttons.

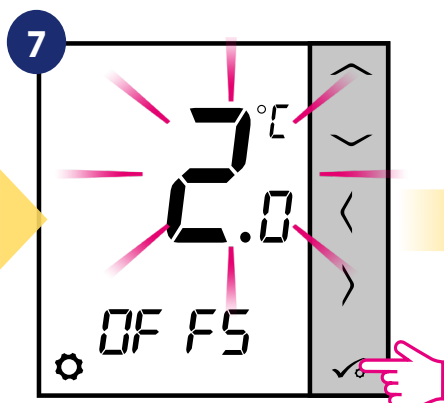

Confirm by ✓ button.

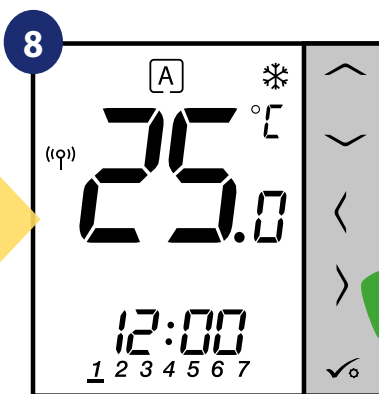

Thermostat will go back to the main screen after saving the settings.

8.3.4 Key lock function

To LOCK/UNLOCK VS10WRF/VS10BRF thermostat keys in **OFFLINE MODE** you have to press and hold $\nabla + \wedge$ buttons for **3 SECONDS**. When thermostat is **locked**, you will see padlock icon on the display. When thermostat is **unlocked** padlock icon is not visible.

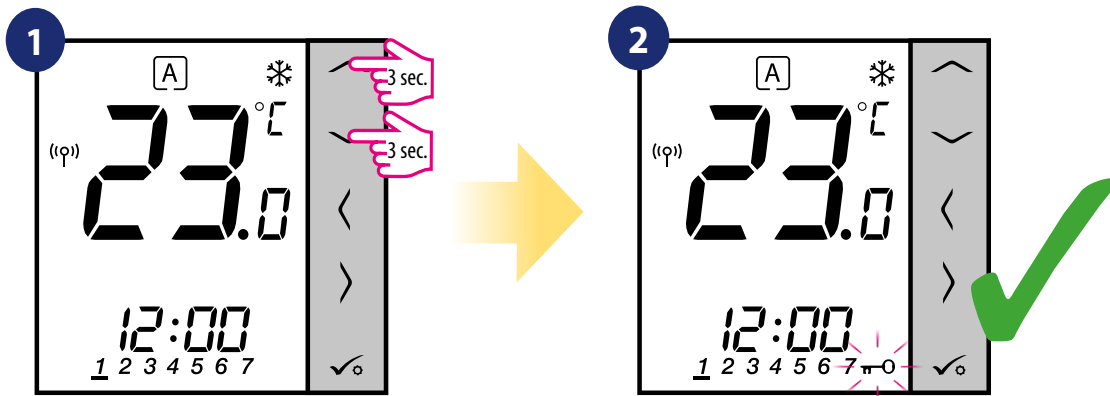

Press and hold $\nabla + \wedge$
buttons for 3 seconds.

Thermostat is locked and key icon is
displaying.

9. Installer parameters

To enter installer parameters please follow steps below. Please refer to parameters table description before any changes. Use ∇ or \wedge buttons to move up or down between all parameters. Every change/selection confirm by \checkmark button:

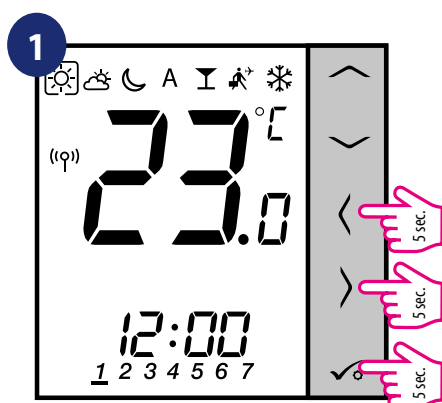

Hold \checkmark + \langle + \rangle buttons for 5 seconds to enter the installer mode.

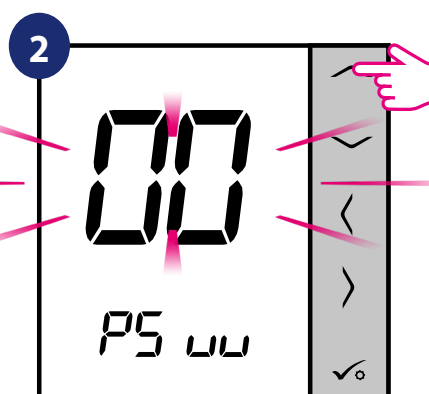

Use ∇ or \wedge to choose code „49“.

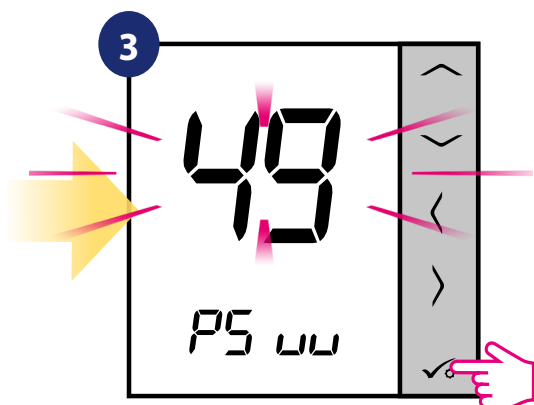

Press \checkmark button to confirm.

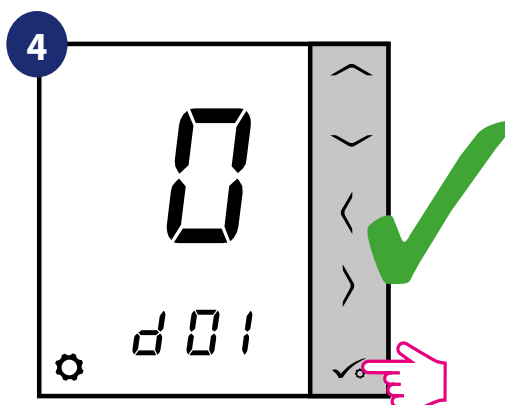

Select installer parameter by \langle or \rangle buttons. Use ∇ or \wedge buttons to change parameter value. Confirm choice by \checkmark button.

dXX	Function	Parameter Values	Description	Default Values
d00	Temperature unit	0	Celsius [°C]	0
		1	Fahrenheit [°F]	
d01	The method of controlling the temperature of the heating system	0	by TPI algorithm	0
		1	SPAN $\pm 0.5^{\circ}\text{C}$	
		2	SPAN $\pm 1.0^{\circ}\text{C}$	
d02	Correction of the displayed temperature	from -3.0°C to $+3.0^{\circ}\text{C}$	If the thermostat indicates an incorrect temperature, it can be corrected by $\pm 3.0^{\circ}\text{C}$	0°C
d03	Floor temperature sensor use (S1,S2)	0	No sensor	0
		1	Temperature sensor connected	
		2	Dew point sensor connected (only in UFH)	
		3	Occupancy sensor connected	

dXX	Function	Parameter Values	Description	Default Values
d04	Internal relay (active when d03=1)	0	The controller measures the temperature only at the external sensor	0
		1	The sensor is used as a protection against overheating of the floor	
d05 (only in UFH)	Control of the cooling mode	1	SPAN $\pm 0.5^{\circ}\text{C}$	2
		2	SPAN $\pm 1.0^{\circ}\text{C}$	
d06 (only with TRV)	TRV control algorithm	0	Standard ON/OFF algorithm	1
		1	Automatic selection	
		2	Advanced self-learning algorithm	
d07	Valve protection	0	Disable	1
		1	Enable	
d08	Frost protection temperature	5-17 $^{\circ}\text{C}$	Frost protection temperature (and for holiday mode)	5 $^{\circ}\text{C}$
d09	Time format	0	12 hours	1
		1	24 hours	
d10	Time zone (reserved for internet wireless)	from -13 to +13 hours	It gives you the possibility to fit the thermostat time zone to yours (every 1 hour step).	0
d11	Summer time change	0	Disabled	1
		1	Enabled	
d12	Heating temperature limit	5-35 $^{\circ}\text{C}$	Maximum heating/cooling temperature that can be set by the user	35 $^{\circ}\text{C}$
d13	Cooling temperature limit	5-40 $^{\circ}\text{C}$	Minimum heating/cooling temperature that can be set by the user	5 $^{\circ}\text{C}$
d14	Max floor temperature (active in heating mode when d04=1)	6-45 $^{\circ}\text{C}$	To protect the floor against overheating, the heating will be switched off when the maximum temperature of the floor sensor is reached.	27 $^{\circ}\text{C}$
d15	Min floor temperature (active in heating mode when d04=1)	6-45 $^{\circ}\text{C}$	To protect the floor, heating will be activated when the minimum floor sensor temperature has been reached.	10 $^{\circ}\text{C}$
d16	Lower floor temperature limit for cooling (Function active when d04 = 1).	6-45 $^{\circ}\text{C}$	To protect the floor, cooling will be switched off when the set minimum temperature is reached.	6 $^{\circ}\text{C}$

FEATURES AVAILABLE ONLY FROM THE APPLICATION LEVEL:

d17	Allow buttons to be unlocked from the thermostat	0	OFF	1
		1	ON	
d18	Deactivate the need to confirm the change of the temperature setpoint by pressing the  button.	0	OFF	0
		1	ON	

10. Factory Reset

To **RESET** VS10WRF/VS10BRF thermostat to its factory default settings please follow steps below:

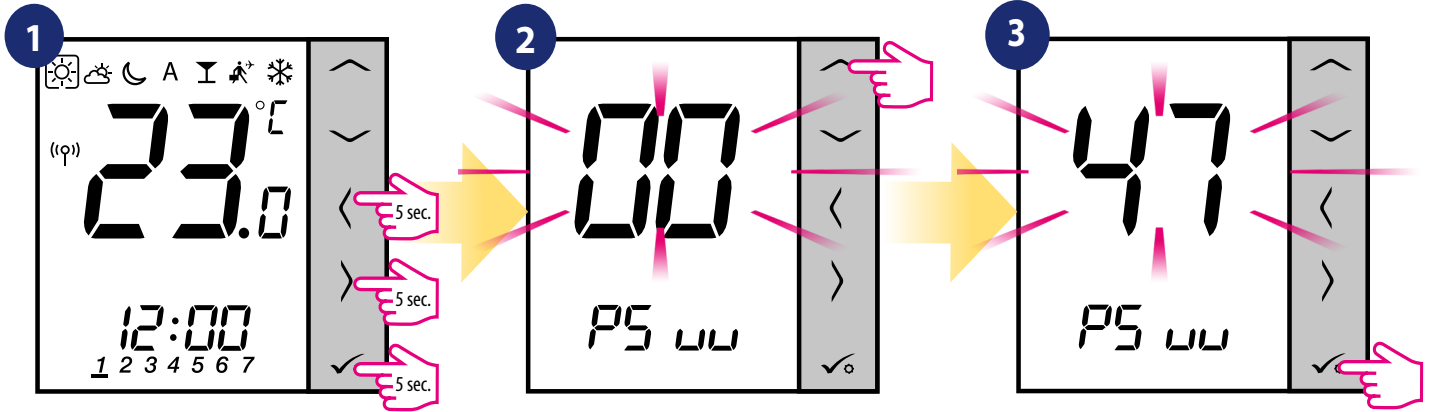

Hold ✓ + < + > buttons for 5 seconds to enter the installer mode.

Use ∨ or ^ buttons to choose code „47”.

Press ✓ button to confirm.

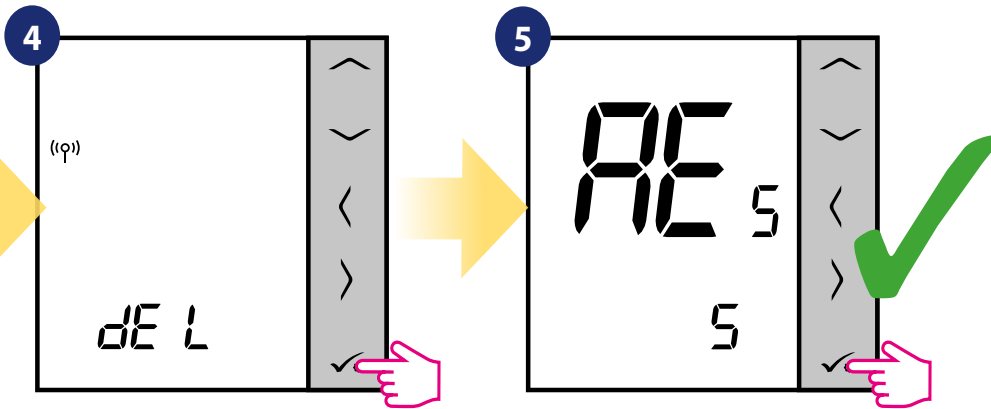

Select „del” and confirm choice by pressing ✓ button.

Wait few moments to finish factory reset procedure.

11. Error codes (error codes description with possible solutions)

Thermostat constantly monitors the network status, wireless connection status and the operation of connected sensors or paired devices. If it detects any failure then following error codes can be displayed alternately with the current room temperature value.

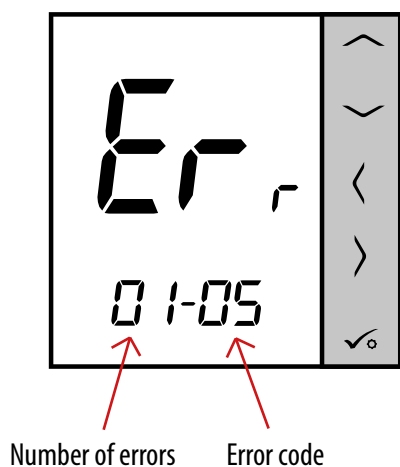

PLEASE NOTE!

In Online mode error is also shown in the Smart Home application (with detailed description). Exclamation mark informs user about existing errors.

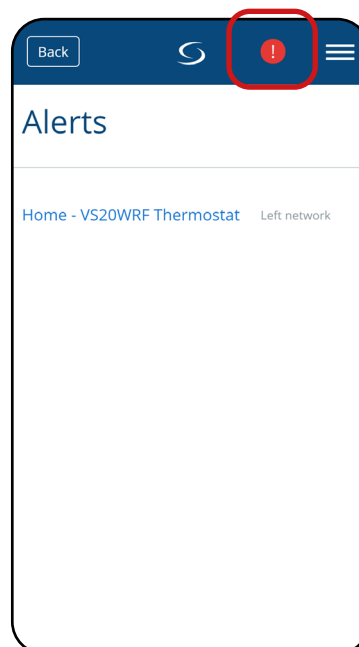

Error codes description with possible solutions:

ERROR CODE	DISPLAY DESCRIPTION	ERROR DESCRIPTION	TROUBLESHOOTING
1.	Err XX-01	TRV paired with thermostat - TRV hardware error.	<ul style="list-style-type: none"> Reinstall the TRV head or replace it. If necessary, contact with the SALUS Technical Department.
2.	Err XX-02	Floor is overheated (heating mode). / Floor is overcooled (in cooling mode).	<ul style="list-style-type: none"> Set the heating medium temperature or change D14 parameter. Set the cooling medium temperature or change D16 parameter.
3.	Err XX-03	Floor sensor is broken.	<ul style="list-style-type: none"> If floor sensor is connected to S1/S2 input, check the wiring. If floor sensor is not connected, check the D03/D04 parameters settings.
4.	Err XX-04	Floor sensor is shorted.	<ul style="list-style-type: none"> Check floor sensor wire insulation for any damages. Sensor resistance for 25°C=10kΩ.
5.	Err XX-05	Thermostat lost contact with the CO10RF network coordinator or the UGE600 internet gateway.	<ul style="list-style-type: none"> Check the coordinator/gateway power supply connection. Force identification process from the coordinator/gateway or thermostat.
6.	Err XX-06	Thermostat lost connection with the wiring centre.	<ul style="list-style-type: none"> Is the wiring centre turned ON and Status Network LED diode solid? If yes, send the heating signal from thermostat to the wiring centre

ERROR CODE	DISPLAY DESCRIPTION	ERROR DESCRIPTION	TROUBLESHOOTING
			(change setpoint temperature). <ul style="list-style-type: none"> If LED diode of the Network Status is flashing, pair the wiring centre with the system in accordance to the manual instruction and pair thermostat with wiring centre.
7.	Err XX-07	Thermostat lost contact with the TRV head.	<ul style="list-style-type: none"> Check TRV head batteries. Send the heating signal from thermostat and check if the TRV head is working. If the LED diode on the TRV head is flashing, repeat the pairing procedure with thermostat according to the manual instructions.
8.	Err XX-08	Thermostat has lost connection with the RX10RF receiver (RX1 mode).	<ul style="list-style-type: none"> Is the RX10RF receiver plugged to the power supply and the top LED diode is red? The Auto/Manual switch has to be set to AUTO position. Force identification process from the coordinator/gateway side and check if the devices are within the network. Send the heating signal from thermostat If the top LED diode is flashing, perform the pairing procedure according to the RX10RF manual instruction.
9.	Err XX-09	Thermostat has lost connection with the RX10RF receiver (RX2 mode).	<ul style="list-style-type: none"> Is the RX10RF receiver plugged to the power supply and the top LED diode is red? The Auto/Manual switch has to be set to AUTO position. Force identification process from the coordinator/gateway side and check if the devices are within the network. Send the heating signal from thermostat If the top LED diode is flashing, perform the pairing procedure according to the RX10RF manual instruction.
10.	Err XX-10	KL10RF wiring centre has lost connection with the DHW time programmer. Error is displayed on all thermostats and on the DHW programmer.	<p>Is the wiring centre turned ON and Status Network LED diode solid?</p> <ul style="list-style-type: none"> If yes, send the heating signal from DHW programmer to the wiring centre. If LED diode of the Network Status is flashing, pair the wiring centre with the system in accordance to the manual instruction and pair DHW timer with wiring centre.
11-18.	Err XX-11 XX-18	Wiring centre has lost connection with thermostat of the given zone: e.g. 11 = with zone 1; 12 = with the zone 2 etc. Error is displayed on all thermostats.	<ul style="list-style-type: none"> Check the thermostat power supply. Send the heating signal from thermostat. If necessary, reinstall the thermostat.
19.	Err XX-19	Wiring centre has lost connection with the CO10RF coordinator/UGE600 internet gateway. Error is displayed on all thermostats.	<ul style="list-style-type: none"> Is the wiring centre turned ON and Status Network LED diode solid? Force identification process from the coordinator/gateway side and check if wiring centre is within the network. If LED diode of the Network Status is flashing, pair the wiring centre with the system in accordance to the manual instruction and pair all thermostats with wiring centre.

ERROR CODE	DISPLAY DESCRIPTION	ERROR DESCRIPTION	TROUBLESHOOTING
20.	Err XX-20	Wiring centre has lost connection with the RX10RF receiver operating in RX1 mode. Error is displayed on all thermostats.	<ul style="list-style-type: none"> • Is the wiring centre turned on? Status Network LED diode should be solid. • Force identification process from the coordinator/gateway side and check if devices are within the network. • If the LED diode of the AUTO/MANUAL receiver switch is flashing, follow the RX10RF manual instruction for pairing.
21.	Err XX-21	TRV head has lost connection with CO10RF coordinator/UGE600 internet gateway.	<ul style="list-style-type: none"> • Check TRV head batteries (replace if necessary). • Check if the coordinator/ internet gateway is connected to the power supply. • Force identification process from the coordinator/gateway side and check if devices are within the network. • Send the heating signal from thermostat.
22.	Err XX-22	Low battery level in the TRV head.	<ul style="list-style-type: none"> • Replace TRV head batteries.
23.	Err XX-23	TRV head's pairing error or head is incompatible with the system.	<ul style="list-style-type: none"> • Remove TRV head from the system and repeat pairing procedure with thermostat.
24.	Err XX-24	Thermostat was rejected by the wiring centre.	<ul style="list-style-type: none"> • Perform the thermostat's pairing procedure again.
25.	Err XX-25	Thermostat has lost connection with the nearest 230V powered device.	<ul style="list-style-type: none"> • Check the power supply of the nearest 230V device. If there is problem with RF signal range, install the ZigBee Network Repeater and pair thermostat with the receiver again (wiring centre, TRV head etc.)
26-29.	Err XX-26 XX-29	Wiring centre has lost connection with thermostat of the given zone: e.g. 26 = with zone 9; 27 = with zone 10; 28 = with zone 11, 29 = with zone 12. Error is displayed on all thermostats.	<ul style="list-style-type: none"> • Check the thermostat's power supply. • Send the heating signal from thermostat. • If necessary, reinstall the thermostat.
30.	Err XX-30	TRV head has a problem with the internal gear mechanism.	<ul style="list-style-type: none"> • Reinstall the TRV head or replace it. If necessary, contact with the SALUS Technical Department.
31.	Err XX-31	Adaptation error of the TRV head assembled on the radiator valve insert.	<ul style="list-style-type: none"> • Check assembly of the TRV head on radiator valve insert and reinstall the TRV head. • Check the compatibility of the TRV head and radiator valve insert; replace the valve insert if necessary.
33.	Err XX-33	The RX10RF receiver has lost connection with thermostat.	<ul style="list-style-type: none"> • Force identification process from the coordinator/gateway side and check if devices are within the network. • Send the heating signal from thermostat side and check if RX10RF receiver is turning ON. • If the top LED diode is flashing, perform the pairing procedure according to the RX10RF manual instruction. • Pair thermostat with the RX10RF receiver again according to the thermostat's manual instruction.

12. Cleaning and Maintenance

The **VS10WRF/VS10BRF thermostat** requires no special maintenance. Periodically, the outer casing can be wiped clean using a dry cloth (please **DO NOT** use solvents, polishes, detergents or abrasive cleaners, as these can damage the thermostat). There are no user serviceable parts within the unit; any servicing or repairs could only be carried out by **Salus Controls** or their appointed agents.

13. Technical Informations

Power supply	230 V AC 50 Hz
Temperature range	5 - 35°C
Temperature measurement accuracy	0.5°C
SPAN	±0.25°C or ±0.5°C
RF	ZigBee 2,4 GHz
Dimensions [mm]	86 x 86 x 42

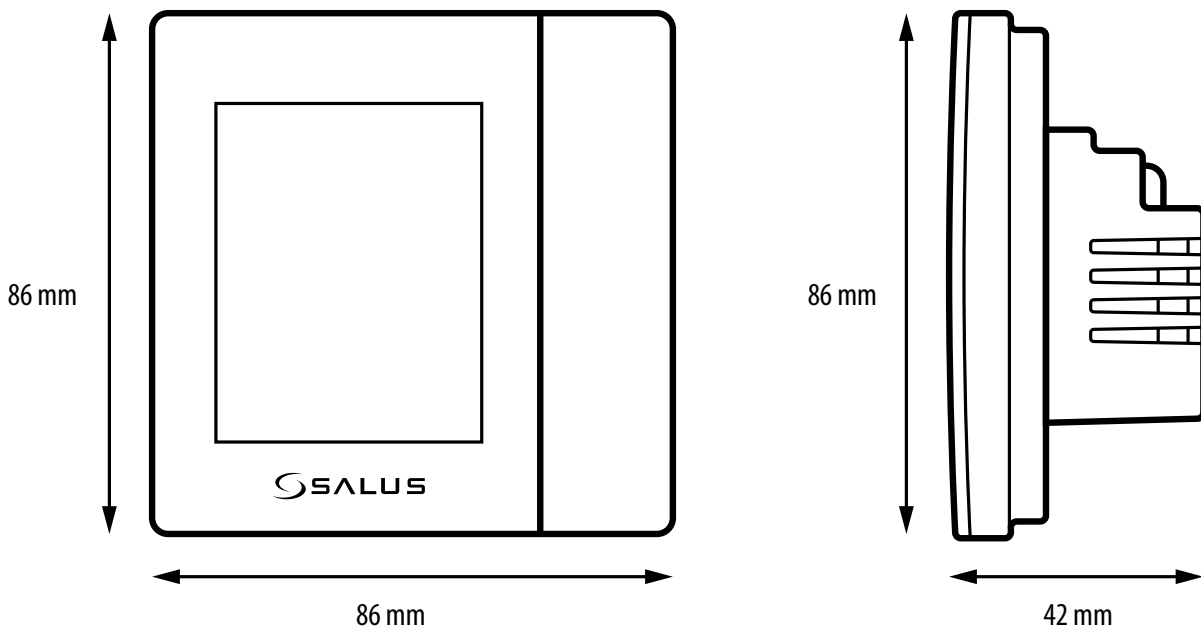

14. Warranty

SALUS Controls warrants that this product will be free from any defect in materials or workmanship, and shall perform in accordance with its specification, for a period of five years from the date of installation. SALUS Controls sole liability for breach of this warranty will be (at its option) to repair or replace the defective product.

Customer Name:	
Customer Address:	
..... Post Code:	
Tel No: Email:	
Company Name:	
Tel No: Email:	
Installation Date:	
Installer Name:	
Installer Signature:	

IMPORTER:

SALUS Controls Plc
Units 8-10 Northfield Business Park
Forge Way, Parkgate
Rotherham
S60 1SD
United Kingdom



www.saluscontrols.com

SALUS Controls is a member of the Computime Group.

Maintaining a policy of continuous product development SALUS Controls plc reserve the right to change specification, design and materials of products listed in this brochure without prior notice.

Issued: 16 VII 2020

Version: 6

