

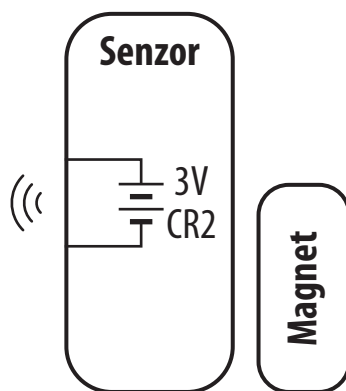















# SW600 - schémy zapojenia



## POUŽITÉ SYMBOLY

	Napájanie z batérie		Bezdrôtová komunikácia
L, N	Napájanie 230V AC		Čerpadlo
	Poistka		Ovládač ventilu
COM, NO, NC	Výstup bez napätia		Teplotný senzor
S, S1, S2	Vstupné svorky		Trojstupňový ventilátor 230V AC
SL	Napätie 230V AC		Žiarovka alebo iné zaťaženie
	Kontakt je normálne otvorený NO		Termoelektrický pohon
	Kontakt je normálne zatvorený NC		Časový programátor
	Prepínač NC / COM / NO		Vonkajší kontakt normálne otvorený
	Kotol – Pripojenie kotla * – Kontakty kotla pre ON / OFF termostat (podľa inštrukcií kotla)		Menič napätia