



## RT520RF THERMOSTAT - FULL USER MANUAL



# TABLE OF CONTENTS

<b>1. Introduction</b>	<b>4</b>
1.1 Product Compliance	4
1.2 Safety Informations	4
<b>2. Product Overview</b>	<b>5</b>
2.1 Example of boilers compatible with the OpenTherm OT+ 4.0 protocol	6
2.2 Montage	7
2.3 Package content	7
2.4 Proper thermostat location	7
<b>3. RXRT520 receiver</b>	<b>8</b>
3.1 Receiver's switches description	8
3.2 LED indications in the receiver	9
3.3 Wall mounting of the receiver	10
3.4 Connection description	11
<b>I A</b> - Boiler connection	11
<b>I B</b> - Pump / Valve connection	11
<b>4. Before you start (first power up)</b>	<b>12</b>
4.1 LCD icon description	12
4.2 Button description	12
4.3 First power up sequence and configuration	13
4.4 OpenTherm - Hot Water configuration	17
4.5 Max boiler temperature settings	17
<b>5. User settings</b>	<b>18</b>
5.1 Manual mode	18
5.2 Schedule mode - programming schedule	19
5.3 Switching between manual and schedule mode	20
5.4 BOOST mode - hourly temperature override (+Hr)	21
5.5 Control and Heat/Cool settings	22
5.6 OFFSET temperature calibration	23
5.7 Landlord settings	24
5.8 Time/Date	26
5.9 Holiday mode	27
5.10 Language	28
<b>6. RT520RF thermostat pairing with the receiver</b>	<b>29</b>
<b>7. Test the pairing process</b>	<b>30</b>
<b>8. Factory Reset</b>	<b>31</b>
<b>9. Error codes</b>	<b>31</b>
<b>10. Battery change</b>	<b>31</b>
<b>11. Cleaning and Maintenance</b>	<b>32</b>
<b>12. Technical Informations</b>	<b>32</b>
<b>13. Warranty</b>	<b>33</b>



## 1. Introduction

### 1.1 Product Compliance

This product complies with the essential requirements and other relevant provisions of Directives 2014/53/EU and 2011/65/EU. The full text of the EU Declaration of Conformity is available at the following internet address: [www.saluslegal.com](http://www.saluslegal.com).

### 1.2 Safety Informations

- Before starting installation work and before using the product, read the entire manual.
- The information contained in the instructions is essential for proper functioning.
- To avoid accidents resulting in personal injury and material damage, please follow all safety precautions, specified in this manual.
- The device should not be used by people with limited mental, sensory or mental abilities, without experience, of insufficient knowledge as well as children.
- Do not use an unassembled device (eg without a cover).
- The device may only be opened by a qualified person.
- Keep electrical devices out of the reach of children and ensure that they do not play with it. Children should not be left unattended. If necessary, disconnect the control system for the entire room.
- Do not leave the packaging, cabinet, or any loose parts of the device unattended, as they pose a risk to children.

#### **WARNING!**

- Installation must be carried out by a qualified person with appropriate electrical qualifications in accordance with standards and regulations in force in the given country and in the EU.
- Never try to connect the device other than as described in the manual.
- Before assembly, repair or maintenance as well as during any connection works it is absolutely necessary disconnect the mains supply and make sure that the terminals and electric wires are not live.
- The device may not be exposed to extreme temperatures, strong vibrations or subjected to mechanical shock.
- The device should not be used in unfavorable environmental conditions or in rooms where there is a concentration of flammable gases, fumes or dust.

#### **WARNING!**

- There may be additional protection requirements for the entire installation that the installer is responsible for maintaining.



Care for the natural environment is of paramount importance to us. The awareness that we manufacture electronic devices obliges us to dispose of used electronic components and devices safely. Therefore the company has received a registration number issued by the Chief Inspector for Environmental Protection. The crossed out symbol the trash can on the product means that the product must not be disposed of with ordinary waste containers. Sorting waste for recycling helps to protect the environment. It is the user's responsibility to surrender used equipment to a designated collection point for recycling waste from electrical and electronic equipment.

## 2. Product Overview

The RT520RF room thermostat simply switches the heating system on and off as necessary. It works by sensing the air temperature, switching on the heating when the air temperature falls below the thermostat setting, and switching it off once this set temperature has been reached.

Turning a room thermostat to a higher setting will not make the room heat up any faster. How quickly the room heats up depends on the design of the heating system, for example, the size of boiler and radiators. Neither does the setting affect how quickly the room cools down. Turning a room thermostat to a lower setting will result in the room being controlled at a lower temperature, and saves energy.

The heating system will not work if a time switch or programmer has switched it off.

The way to set and use your room thermostat is to find the lowest temperature setting that you are comfortable with, and then leave it alone to do its job. The best way to do this is to set the room thermostat to a low temperature – say 18°C – and then turn it up by one degree each day until you are comfortable with the temperature.

You won't have to adjust the thermostat further. Any adjustment above this setting will waste energy and cost you more money.

If your heating system is a boiler with radiators, there will usually be only one room thermostat to control the whole house. But you can have different temperatures in individual rooms by installing thermostatic radiator valves (TRVs) on individual radiators. If you don't have TRVs, you should choose a temperature that is reasonable for the whole house. If you do have TRVs, you can choose a slightly higher setting to make sure that even the coldest room is comfortable, then prevent any overheating in other rooms by adjusting the TRVs.

Room thermostats need a free flow of air to sense the temperature, so they must not be covered by curtains or blocked by furniture. Nearby electric fires, televisions, wall or table lamps may prevent the thermostat from working properly.

Thermostat is compatible with OpenTherm OT+ 4.0 version.

The OpenTherm protocol is an open standard communication protocol used in central heating systems for two-way communication between a central heating boiler and a room thermostat. Thanks to the communication protocol, the boiler power is modulated, which can significantly increase the energy efficiency of the heating system while maintaining the set temperature in the room. OpenTherm modulation, compared to standard communication (ON / OFF), occurs by setting the desired temperature of water from the boiler (boiler power), and not by its cyclical switching on and off.



### PLEASE NOTE!

Make sure your gas combi boiler is compatible with OT + 4.0 communication protocol.  
The list of compatible boilers is on the next page.

### Product advantages:

- set is factory-paired and ready to work
- option to choose Hysteresis or built-in TPI algorithm for all types of heating
- works with time schedules
- service mode protected by a PIN code
- maximum / minimum temperature limitation
- can temporarily change the temperature (overwriting until the next program change)
- has unique transmission codes
- operates at 868 MHz - a stable and noise-resistant signal

## 2.1 Example of boilers compatible with the OpenTherm OT+ 4.0 protocol

COMPANY	MODEL	COMPANY	MODEL
Alpha Heating	E-Tec S E-tec Plus E-tec Evoke Intec GS	Vokera	Linea HE Mynute A Mynute HE Unica HE
Atag	iC iC Economiser iS	Viessmann	Vitodens 100W Typ WB1A (Connection: X3.3 and X3.4) Vitodens 100W Typ WB1B (Connection: X21.1 and X21.2) Vitodens 100W Typ WB1C (Connection: X21.1 and X21.2) Vitodens 200-W WB2B 26+ 35 kW (via Expansion Module OT and OT-A8 + _Terminal -10 and +10 are on the extension of the A8 boiler) Vitodens 200-W WB2C, B2HA,B2JA, B2LA (via icm Expander OpenTherm)
Baxi	100 Combi 200 Combi 400 Combi 600 Combi	Vaillant (via Vaillant VR33 module)	Ecotec Pro Ecotec Plus Ecotec Exclusive Ecofit Pure
Daikin	D2CND 24Kw D2CND 28kw D2CND 35kw	Worcester Bosch (via Nefit EMS-OT OpenTherm converter)	EMS capable boilers Greenstar i Greenstar i Junior (Made in July 2013) Greenstar Si Compact Greenstar CDi Compact Greenstar CDi Classic (Made after 16.01.2007 with CF12.10 software version and newer) Greenstar Highflow CDi Greenstar 12i System – 24i System (On condition that an optional integrated diverter valve manufactured after February 2011 is installed) Greenstar 27i System – 30i System (Provided the optional Integrated Changeover Valve is installed Greenstar CDi Classic System (provided the optional Integrated Changeover Valve manufactured after 02/16/2007 with software version CF12.10 and above is installed))
Ferrol	i25 Condensing Combination Boiler i29 Condensing Combination Boiler		
Ideal	Independent + Combi Independent Combi Independent System Logic Combi+ Combi C Logic Combi C24, C30, C35 (via a separate bundle set) Logic Code Combi (via a separate bundle set) I-mini C24, c30 (via a separate bundle set) Vogue Combi C26,C32, C40 Logic + System Logic + Heat		
Intergas	Intergas Rapid Intergas Rapid Plus Combi Compact, Compact Range ECO RF Xtreme Xclusive		
Main	Eco Compact Combi 25-30		
Navien	Navien NCB		
Ravenheat	Avanta, Quinta Ace Quinta Pro Gas 110 Eco		
Vokera	Evolve C Evolve S Linea One (przez OpenTherm Kit Part_1221179) Vision Combi (requires a control interface 294501430) Compact A (requires a control interface 29450143) Verve (only heating mode) Mynute I (only heating mode) Vision System (only heating mode) Unica I Vibe Vision C		

## 2.2 Montage

## 2.3 Package content

- 1) RT520RF thermostat
- 2) Thermostat bracket
- 3) RXRT520 receiver
- 4) 2x AA batteries
- 5) Short instruction
- 6) Mounting screws



## 2.4 Proper thermostat location

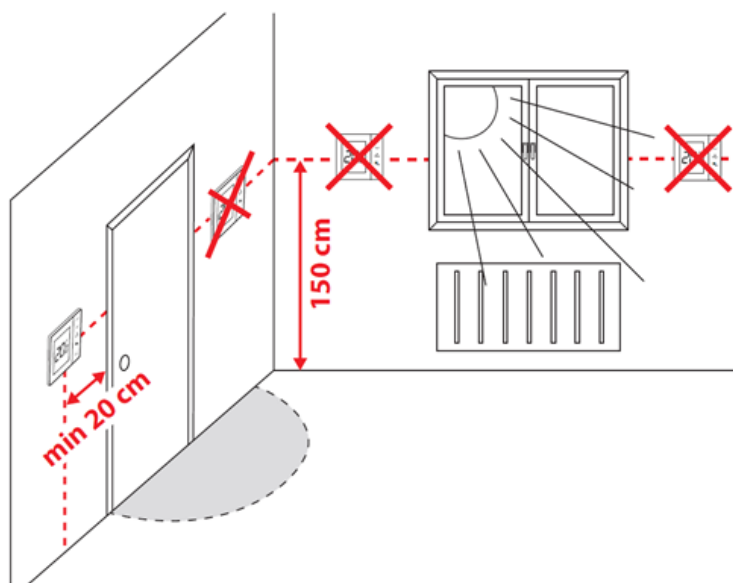

### Please note:

The ideal position to thermostat mounting is about 1,5m under floor level far from heating or cooling sources. Thermostat can't be exposed to sunlight or any extreme conditions like for example draft.

Because of fire and explosion risk there is not allowed to use thermostat in atmosphere of explosive gases and flammable liquids (eg coal dust). In case if any of listed dangers occur you have to use additional protection measures – anti-dust and explosive gases (tight cover) or prevent their formation. Furthermore, thermostat can't be used in condensation of water vapor conditions and be exposed to water action.

### 3. RXRT520 receiver

The thermostat communicates wirelessly with the RXRT520 receiver. The receiver should be supplied with 230VAC, the maximum load of the receiver is 16A. Avoid installing the device in places directly exposed to water, moisture and air condensation. The RXRT520 receiver can operate in two different modes - AUTO (automatic) and MANUAL (manual). To select a specific mode, use the buttons on the front of the receiver.



#### 3.1 Receiver's switches description

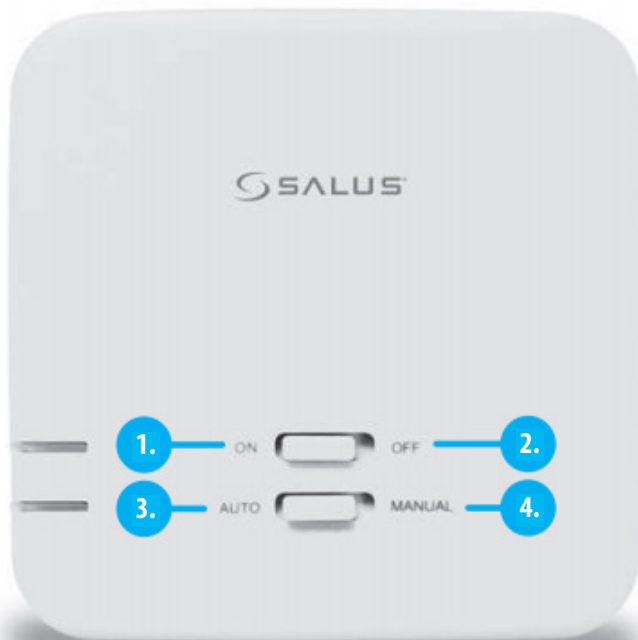

TOP SWITCH	
1.	<b>ON - Manual mode</b> - receiver ON
2.	<b>OFF - Manual mode</b> - receiver OFF
BOTTOM SWITCH	
3.	<b>AUTO</b> - Receiver works in <b>AUTO mode</b> (according to the thermostat's command)
4.	<b>MANUAL</b> - Receiver works in <b>manual mode</b> (according to the top switch)



#### REMEMBER!:

For the receiver to work with the thermostat, set the switches to the ON / AUTO position.



### 3.2 LED indications in the receiver

The status of the RXRT520 receiver is indicated by two LEDs. These are LEDs with the following colors:

- 1 - red (upper one),
- 2 - green (lower one).

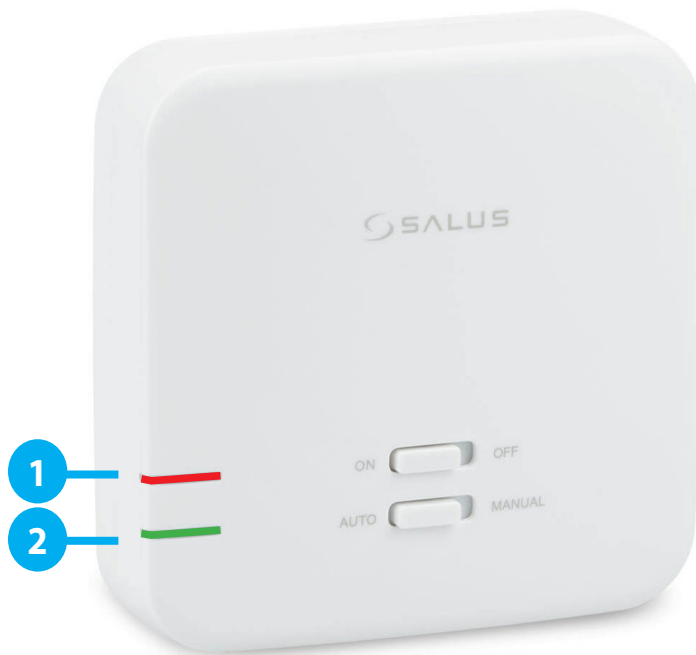

A detailed explanation of the meaning of the LEDs can be found in the table below:

	MEANING
<b>The red LED lights up</b>	<p>The receiver is connected to the 230V power supply and is paired with the thermostat.</p> <p>The receiver can be thermostat-enabled if it is in automatic mode when the lower switch is in the AUTO position.</p> <p>The receiver can be started manually when the lower switch is in the MANUAL position.</p>
<b>The red LED flashes</b>	<p>The receiver is in the pairing mode and is looking for a signal from the thermostat (then you must activate the "PAIRING" option in the thermostat)</p> <p>(or)</p> <p>The receiver was paired but lost communication with the thermostat due to out of range or low battery in the thermostat. The receiver starts flashing after one hour of time when it does not receive a signal from the thermostat.</p>
<b>The red diode is off</b>	<p>The receiver is disconnected from the 230V power supply or the upper switch is in the OFF position.</p>
<b>The green diode lights up</b>	<p>In automatic mode, the receiver received a heating signal from the thermostat.</p> <p>The receiver was started in manual mode (upper ON switch, lower MANUAL switch)</p>
<b>The green diode is off</b>	<p>The receiver does not send a heating signal.</p>

### 3.3 Wall mounting of the receiver

**Wall mounting the receiver:** drill two  $\varnothing 6$  mm holes in the wall. Insert the plugs and, by putting the plate to the wall (included in the set), put the two screws through the holes and then screw them in. Connect the necessary cables to the receiver. Next, hang the receiver on the board using the handles designed in the receiver, marked in the picture below.



1  
Loosen the screws with a screwdriver just enough to tilt the back housing.

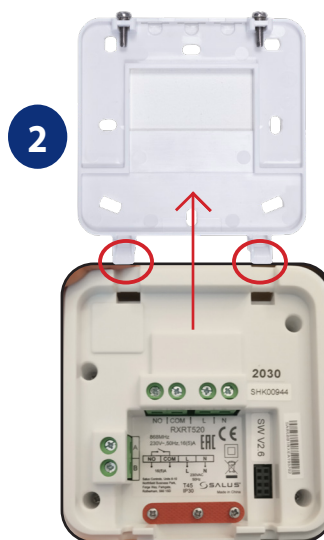

2  
Tilt the receiver cover upwards (according to the position of the „hinge”).



3  
Attach the back housing to the wall (keeping the correct positioning of the plastic „hinges”) using the marked holes (see the picture above).

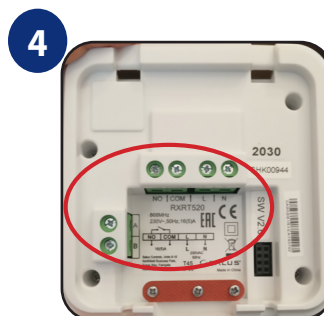

4  
Then, correctly connect the wires included in the set with the receiver (see „connection diagrams” on page 11).

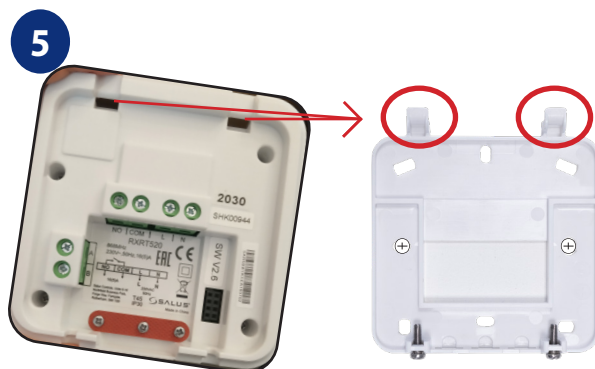

5  
Put the receiver from above on the back housing attached to the wall, according to the position of the plastic „hinges”.

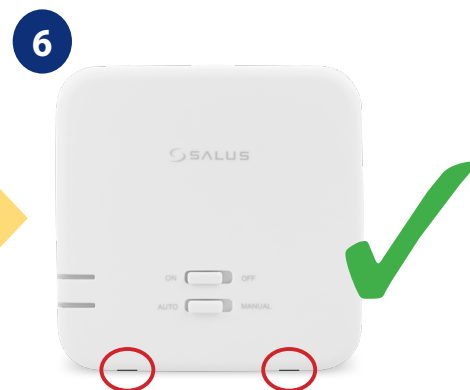

6  
Tighten the screws from the bottom of the back housing.

### 3.4 Connection description

#### I A - Boiler connection

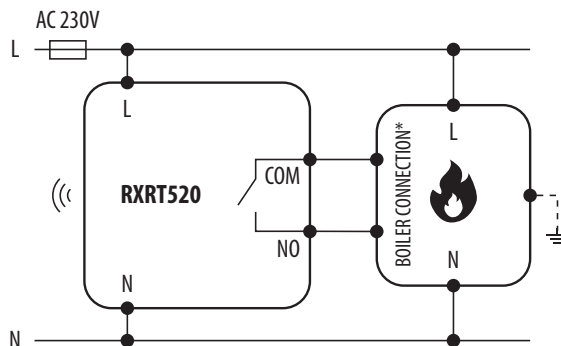
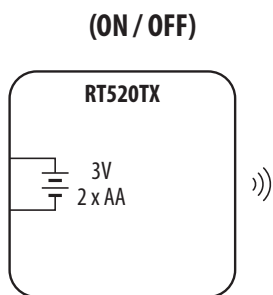

or

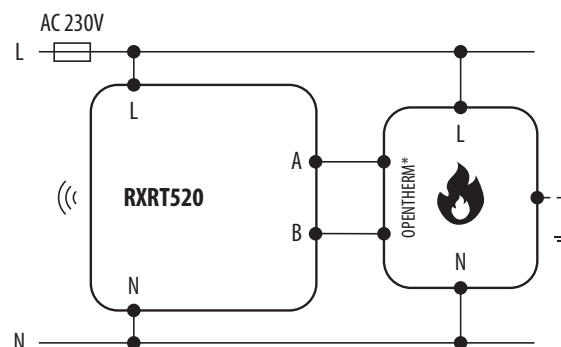
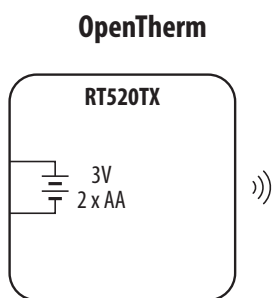

#### I B - Pump / Valve connection

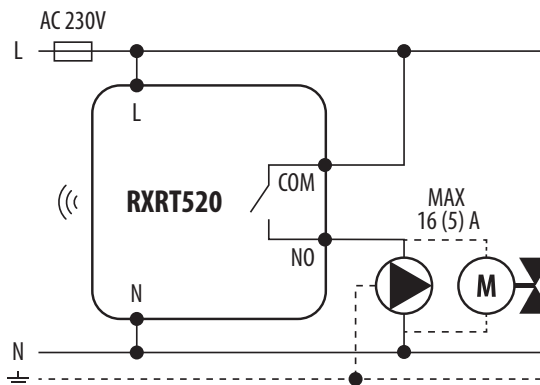
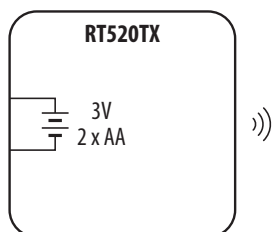

#### Legend:



**Boiler - Boiler connection\***  
- Boiler's contacts for ON/OFF thermostat (according to the boiler's instructions)



Pump



Valve

#### Symbols explanation:

L, N - power supply 230V

NO, COM, NC - voltage-free output

A, B - OpenTherm Communication Wire

- fuse

## 4. Before you start (first power up)

### 4.1 LCD icon description

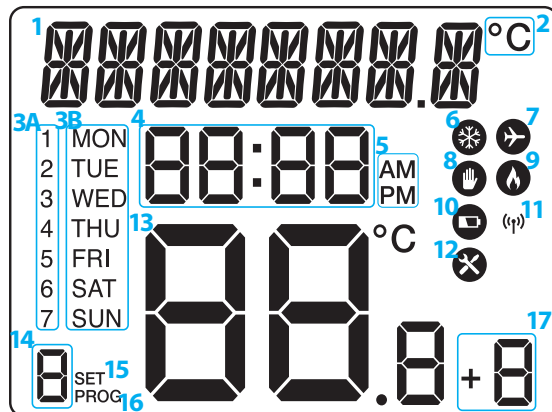

- |                                  |   |
|----------------------------------|---|
| 1. Text Bar                      | 9. Heating Mode On                        |
| 2. Temperature Unit              | 10. Low battery status                    |
| 3A. Day of the week (numeric)    | 11. Wireless connection with the receiver |
| 3B. Day of the week (alphabetic) | 12. Service Mode On                       |
| 4. Clock                         | 13. Temperature measured / set            |
| 5. AM / PM                       | 14. Program number                        |
| 6. Cooling Mode On               | 15. Settings                              |
| 7. Holiday Mode On               | 16. Program indicator                     |
| 8. Manual Mode On                | 17. Boost function                        |

### 4.2 Button description

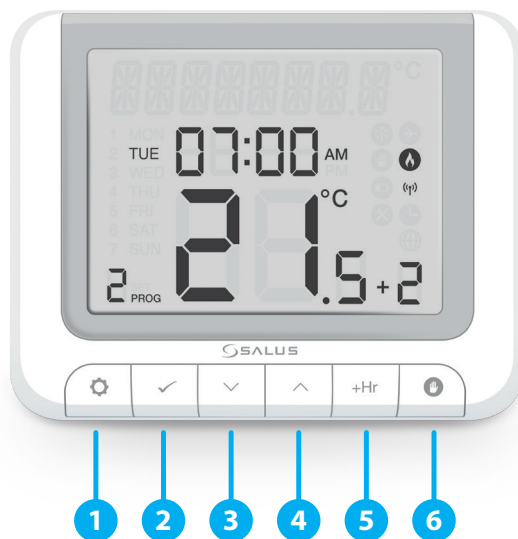

- |  |  |
|--|--|
| 1. MENU / RETURN - enter the menu options, press and hold for 3 sec to return to main screen or to deactivate Boost or Manual modes. | 4. UP - increase the temperature and move through menus.                                 |
| 2. SELECT - confirm changes and enter menus.   | 5. BOOST - activate Boost Mode.  |
| 3. DOWN - decrease the temperature and move through the menus.   | 6. MANUAL - press once to activate / press and hold for 3 sec to deactivate Manual Mode. |



**PLEASE NOTE!** The LCD screen can be activated by using any button.

### 4.3 First power up sequence and configuration



Please make the receiver connections and power the receiver before inserting the batteries into the thermostat.

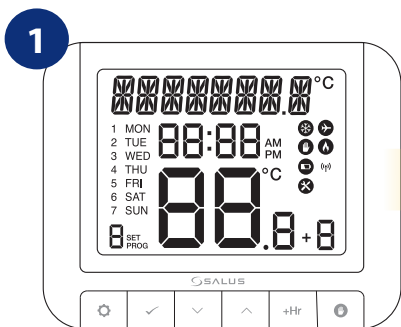

After inserting the batteries, the thermostat will power up.



Press .



Using or , choose your language and then press .

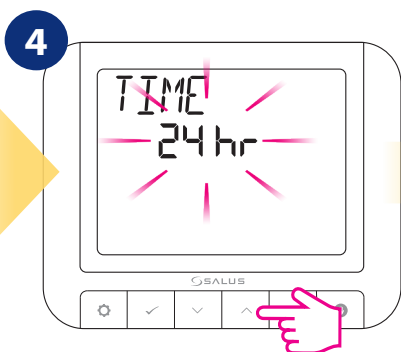

Using or , choose the time format.

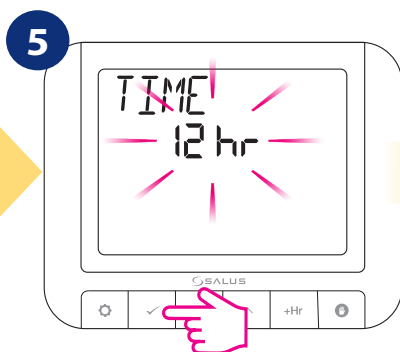

Press to confirm.

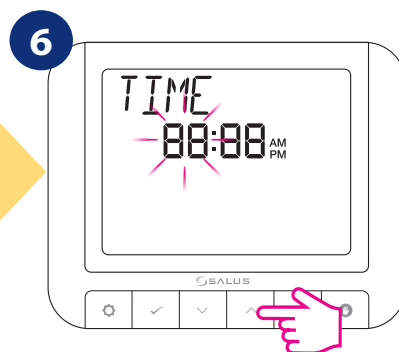

Using or , set the hour and then press .

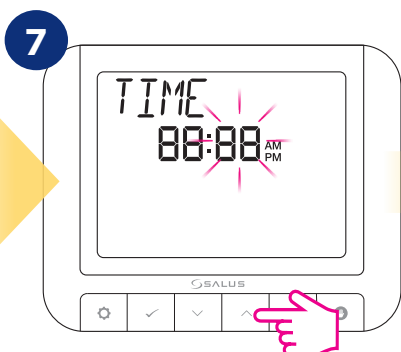

Using or , set the minutes and then press .

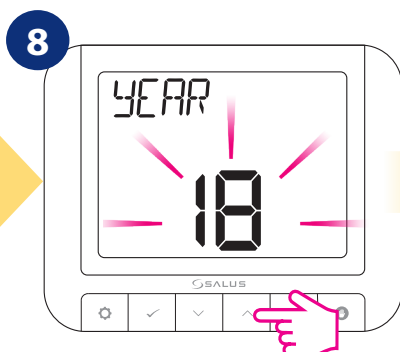

Using or , set the year and then press .

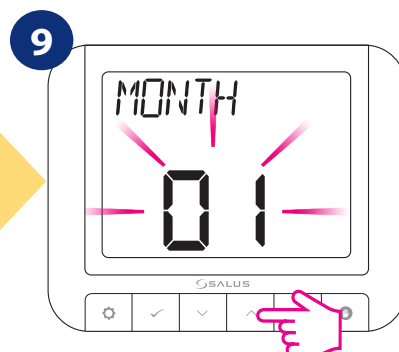

Using or , set the month and then press .

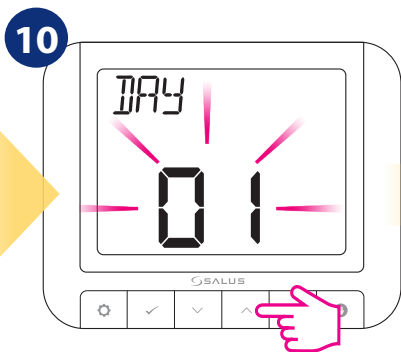

Using or , set the day and then press .

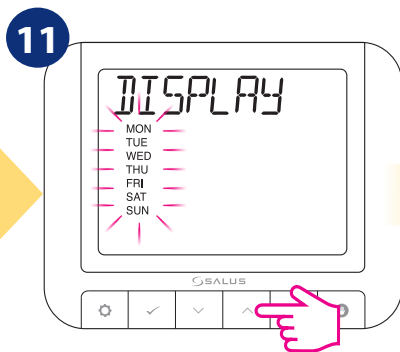

Using or , select the week format.

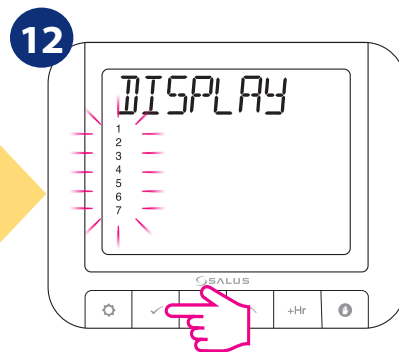

Press to confirm.

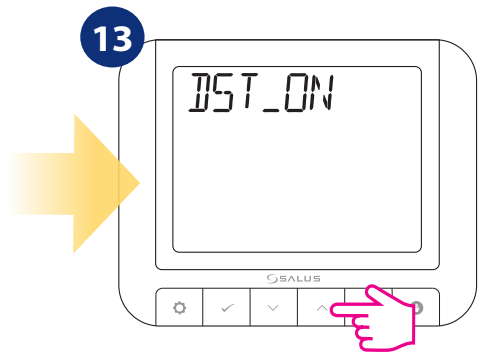

Using  or , enable or disable DST (Daylight Saving Time).

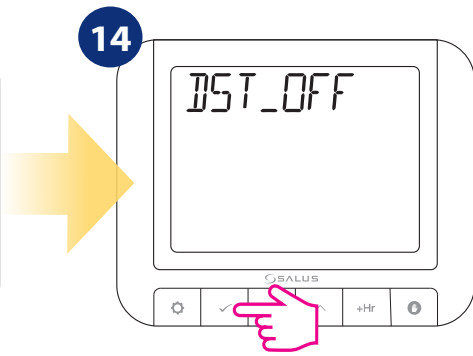

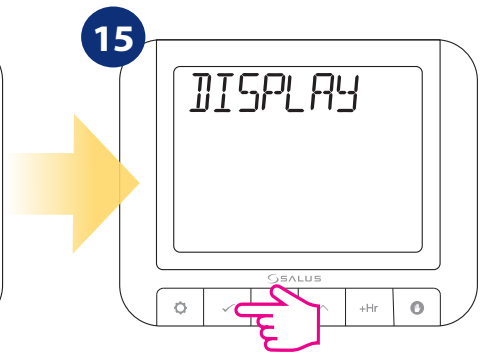

Press  to confirm.

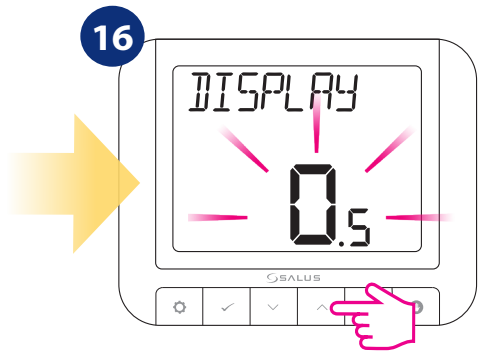

Press .



Using  or , select your temperature accuracy.

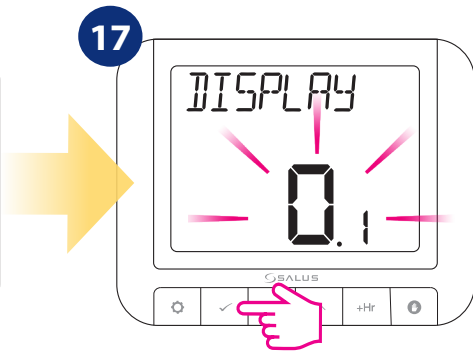

Press  to confirm.

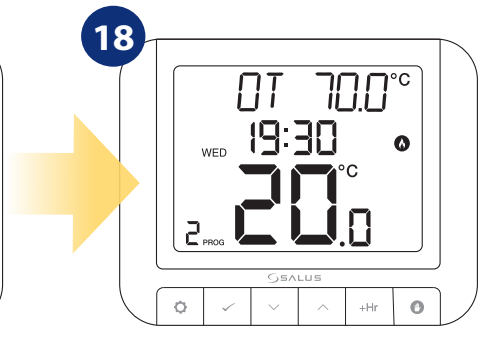

When OpenTherm is connected, the device software will automatically adjust to the OpenTherm settings.

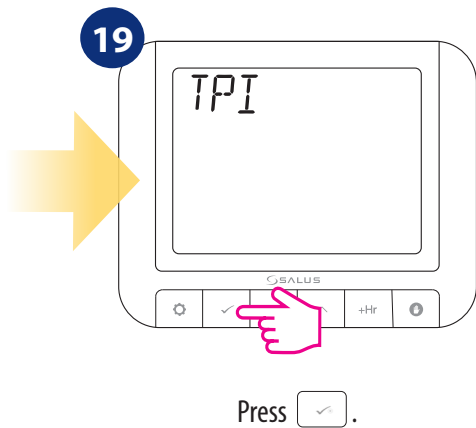

TPI (Time Proportional & Integral) is a self-learning, time-proportional algorithm. TPI type of regulation ensures economical system operation through more accurate temperature maintenance during controlling process and limits overload conditions. In addition to the exact and stable room temperature, the advantage of this system is the minimization of energy consumption and significant savings. RT520RF offers 3 types of TPI control: 1. for radiator (6CPH); 2. for underfloor heating (3CPH); 3. for electric heating (9CPH).

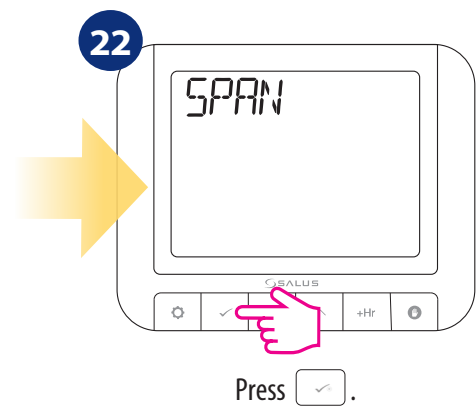
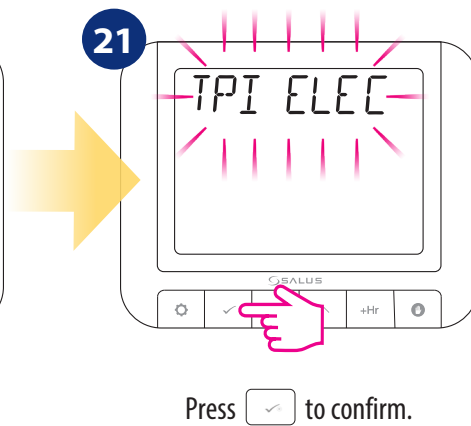
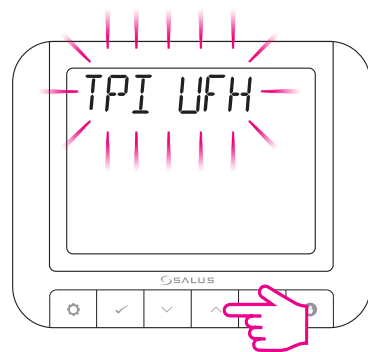
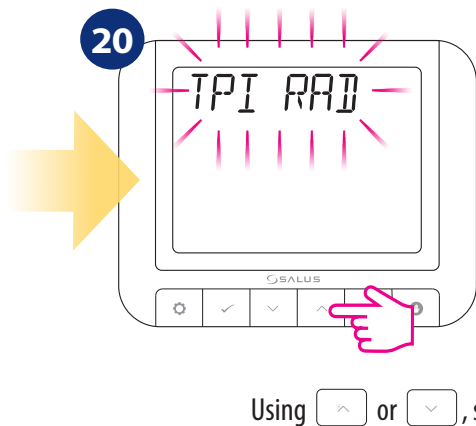

Span is the temperature difference, between which thermostat operates and keeps setpoint temperature. For example, if you set setpoint temperature to 20°C and if the hysteresis is  $\pm 0.5^\circ\text{C}$ , heating will be turned on when the room temperature drops to 19.5°C and turned off when the room temperature reaches 20.5°C.

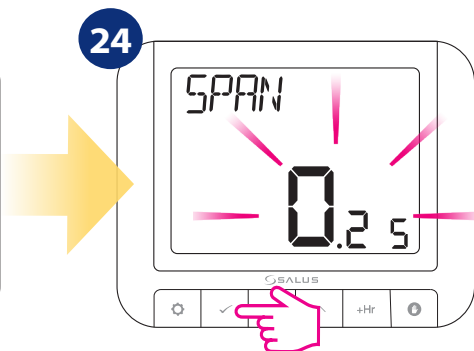
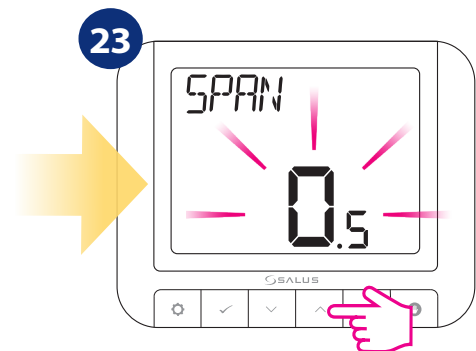

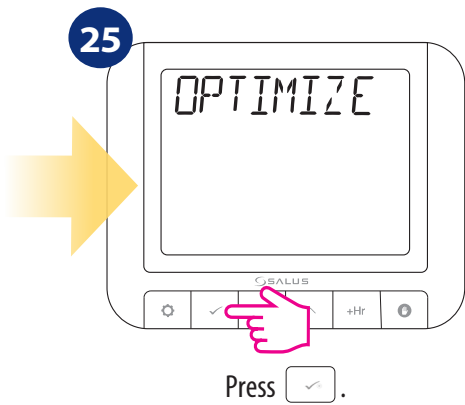

The optimization function is an energy-saving algorithm for the effective control of the heating device, ensuring better thermal comfort at certain times of the day. When the OPTIMUM START function is active, the thermostat sends a heating signal to the heat source beforehand so that the preset temperature in the room is reached at the time specified in the schedule.

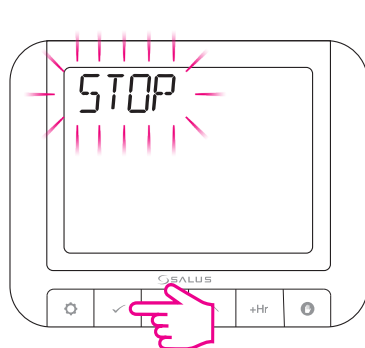
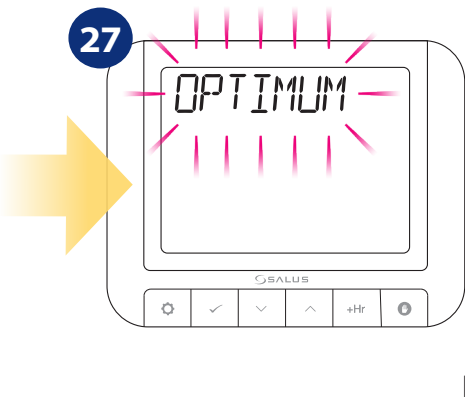
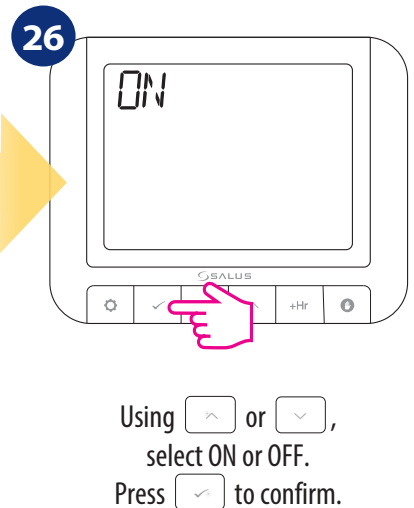
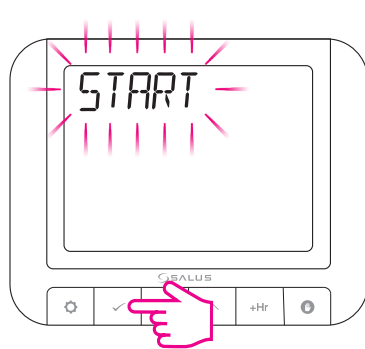
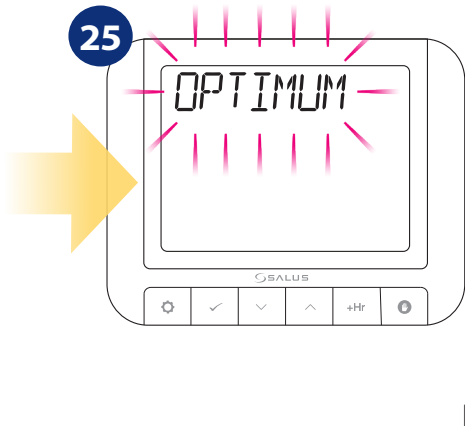

When the OPTIMUM STOP function is active, the thermostat, taking into account the inertia of the system, switches off the heat source earlier, keeping the temperature set in the schedule.

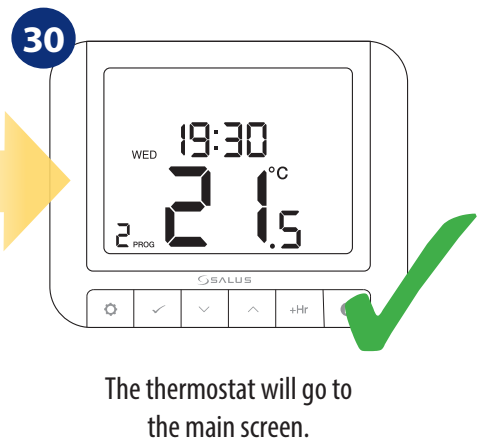
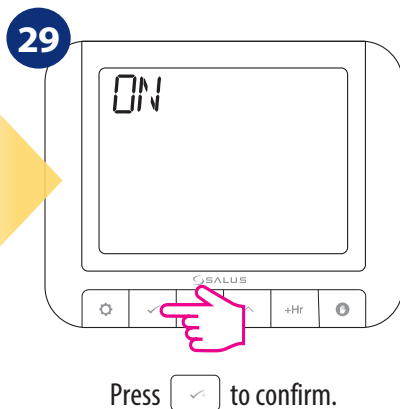
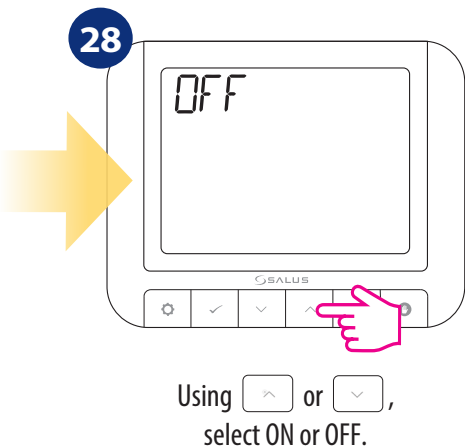



## 4.4 OpenTherm - Hot Water configuration

RT520RF can be configured in Hot Water OPENTHERM system. To configure it follow steps below:

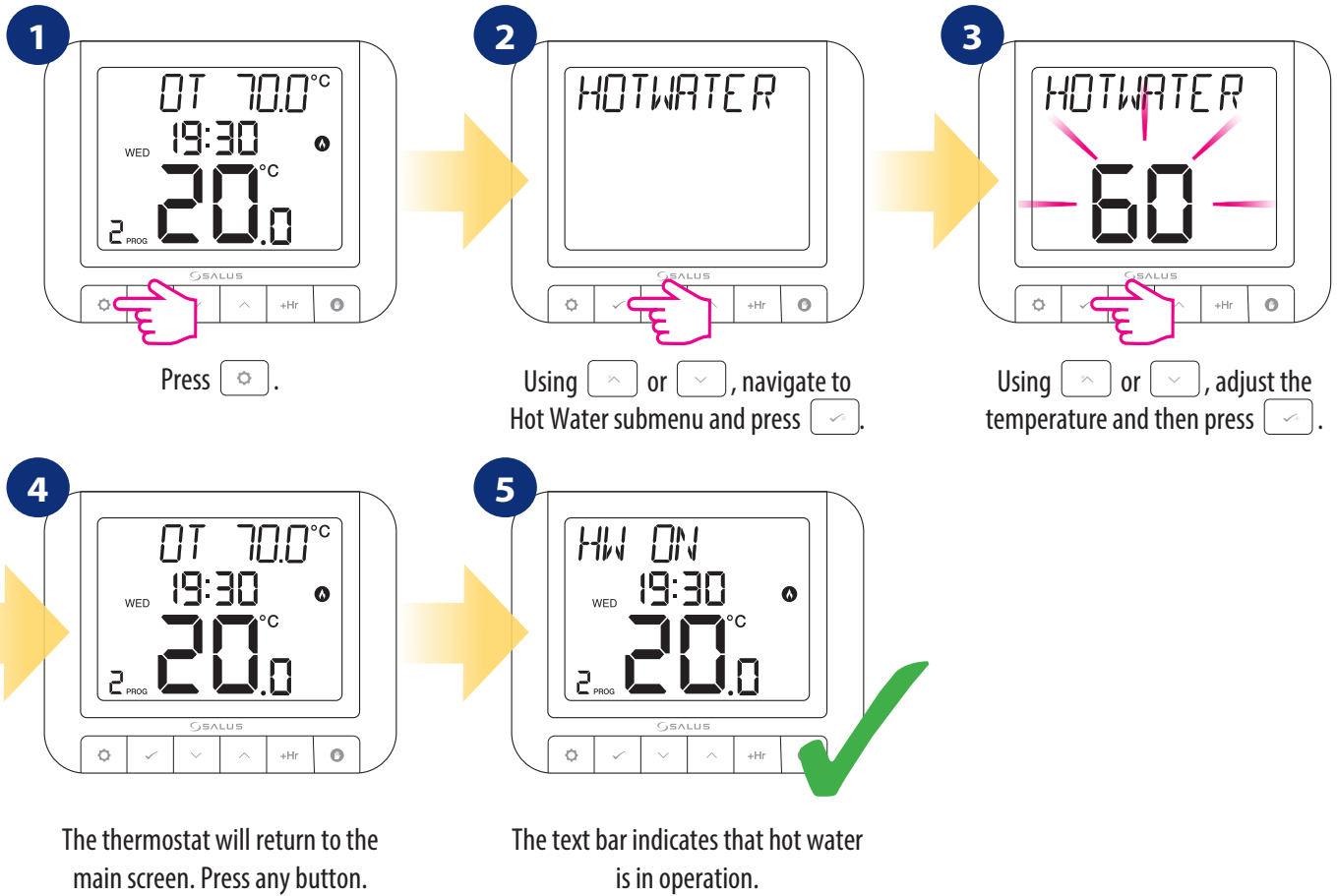

## 4.5 Max boiler temperature settings

In this chapter you will learn how to set max temperature for connected boiler. Follow steps below:

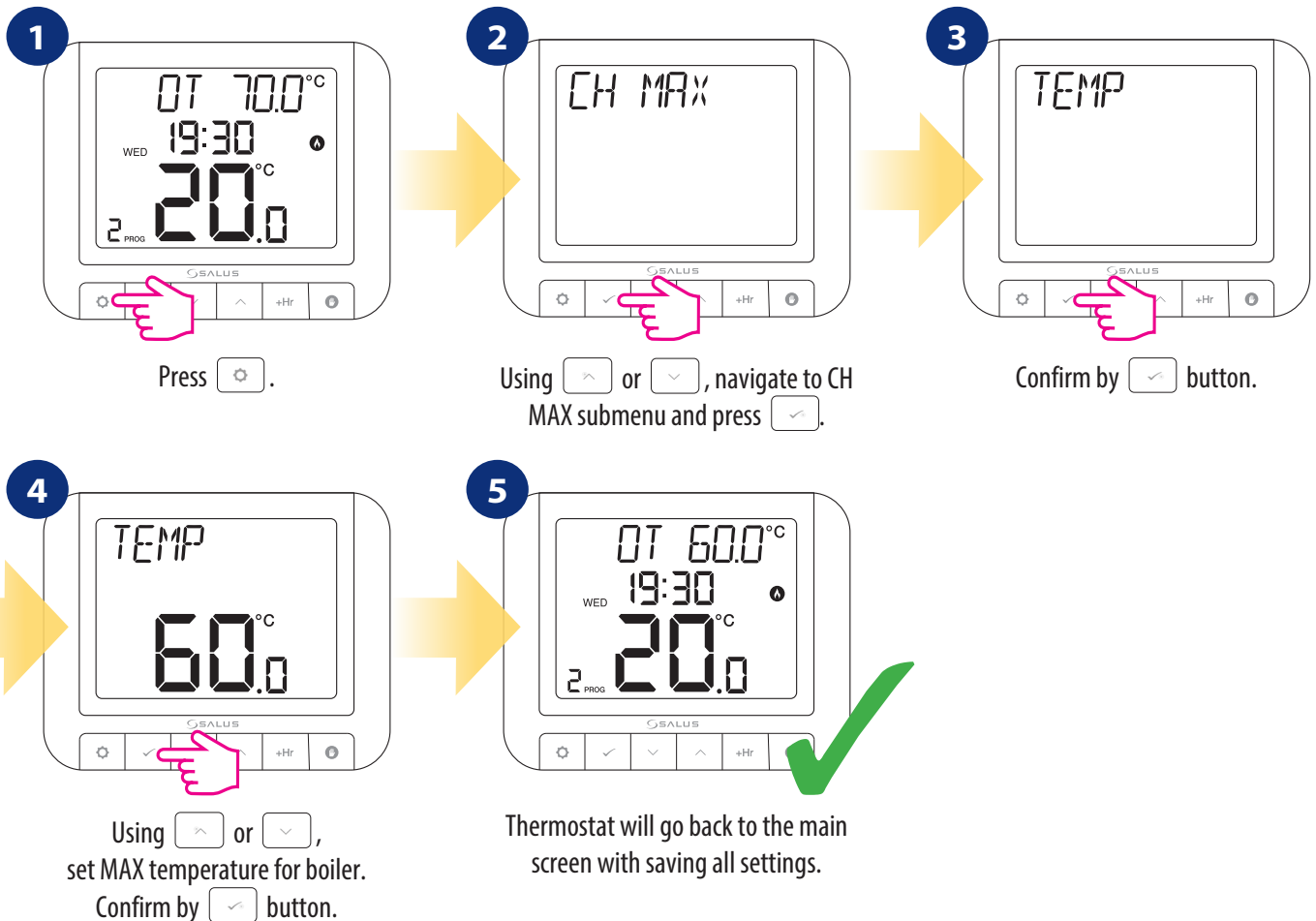

## 5. User settings

### 5.1 Manual mode

In manual mode, the thermostat maintains a constant temperature set by the user. To exit mode, press and hold  button for 3 seconds. A hand icon is displayed when manual mode is active.

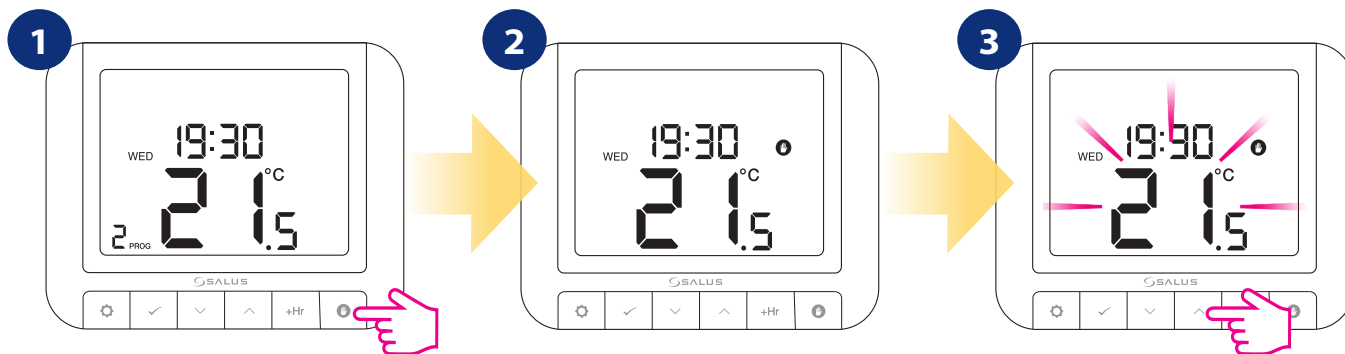

Press  button.

A hand icon will appear, which means that thermostat is in manual mode.

To set temperature use  or  button.

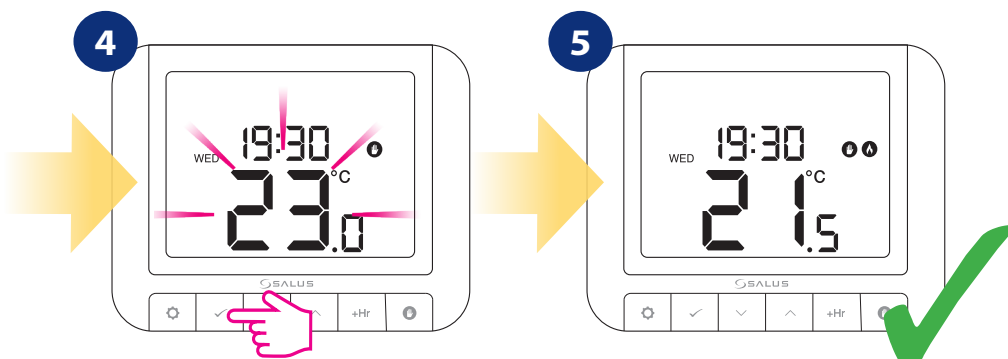

Confirm your choice using  button.

Thermostat will maintain the temperature until manual change or manual mode exit (press and hold  button for 3 seconds).

## 5.2 Schedule mode - programming schedule

In this mode, user can set the schedules for thermostat (temperature setpoints for specific periods of time). Programmed schedules should use all time periods.

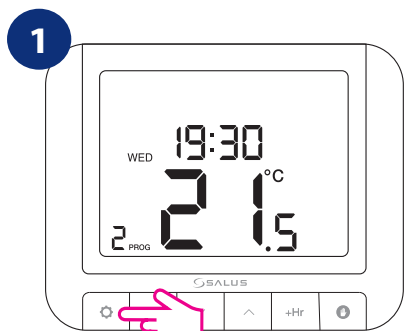

Press .

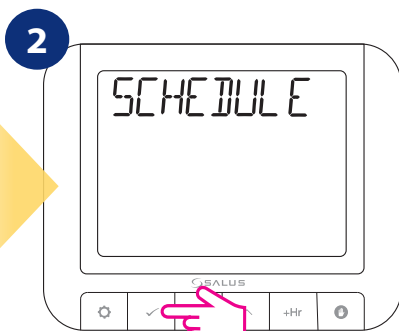

Press .

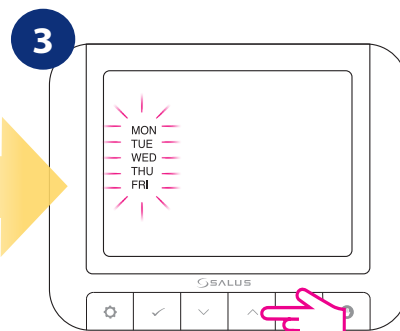

Using or , select the program type between: **5**

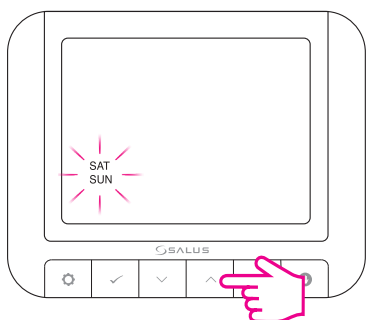

**+2** (schedule for the working days and for the weekend)

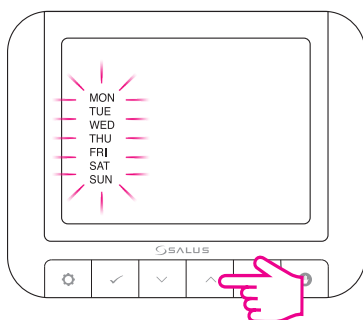

**All** (set one schedule for the entire week)

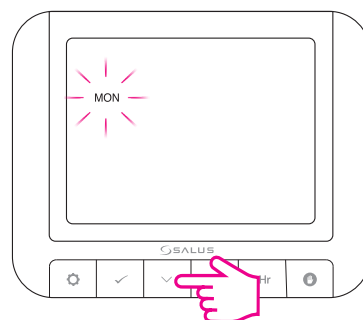

**Individual** (set a daily schedule).

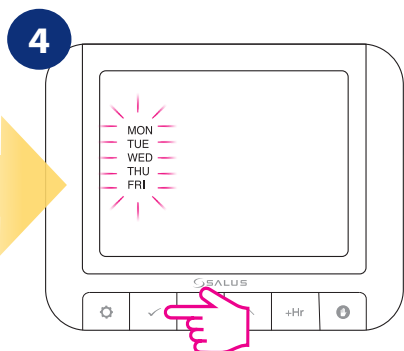

Press to confirm.

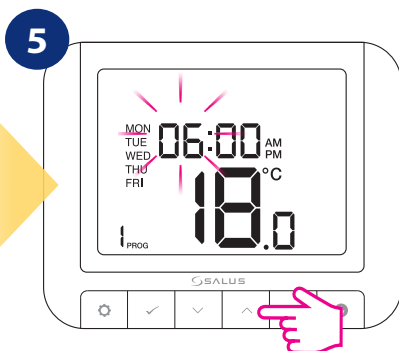

Using or , set the hour and then press .

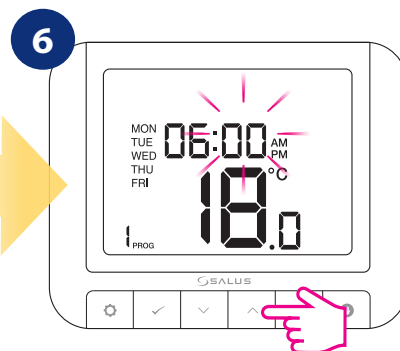

Using or , set the minutes and then press .

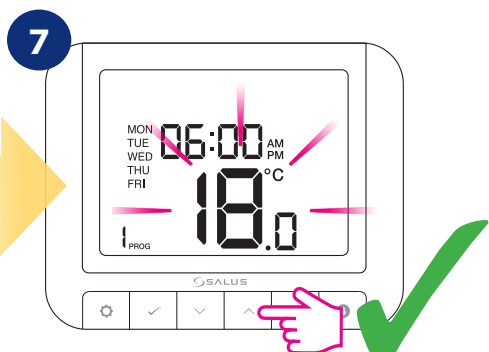

Using or , set the temperature and then press .



Repeat the process for all time periods.

### 5.3 Switching between manual and schedule mode

In this option, user can switch between manual and schedule mode by using  button. To do that please follow steps below:

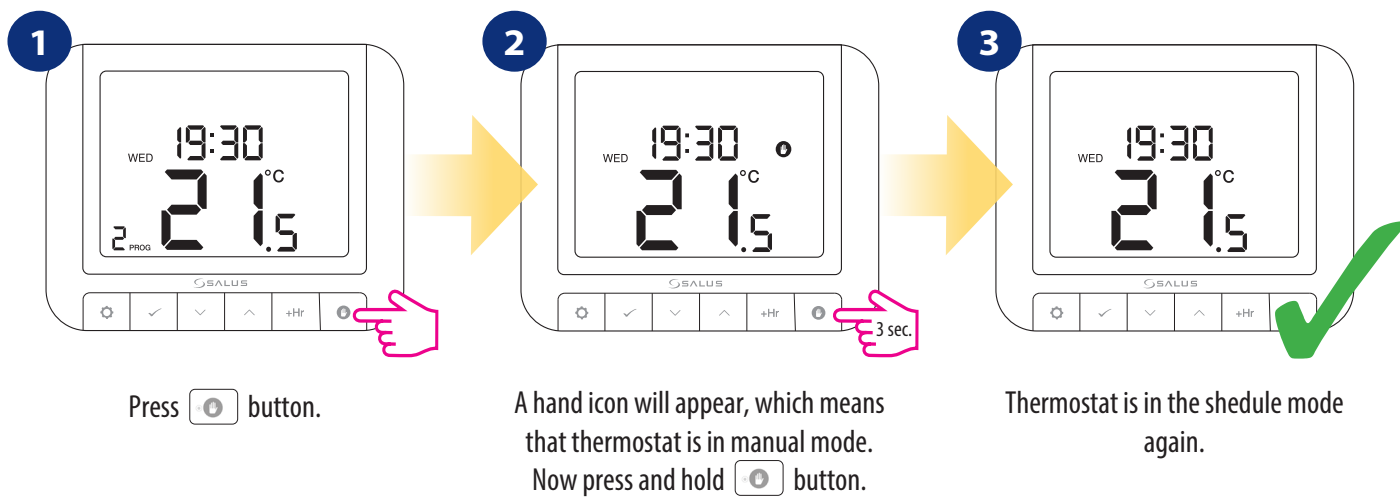

## 5.4 BOOST mode - hourly temperature override (+Hr)

The function is available in automatic and manual mode. Used to change the temperature to the desired value for a specified number of hours (up to 9 hours). After the elapsed time, the thermostat returns to the previous operating mode.

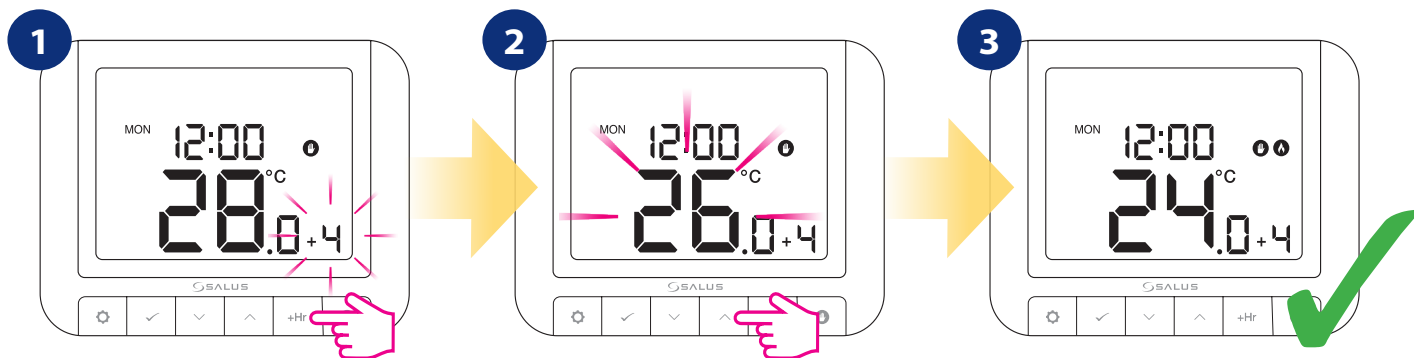

Press +Hr button to set hour for temporary override (eg. 4 hours = 4 times button pressing). Confirm by  button.

Using  or  buttons set the temperature for BOOST mode. Confirm by  button.

Thermostat is working in BOOST mode for 4 hours and it will maintain temperature setpoint for 4 hours.

### How to stop BOOST mode:

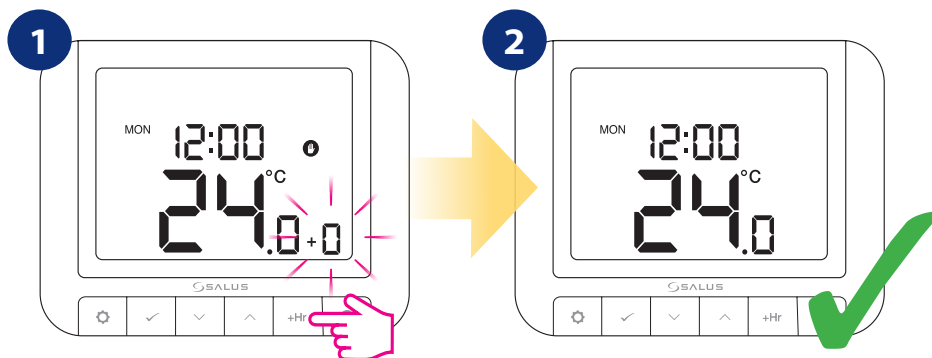

Hold  button for 3 seconds or press +Hr button several times until "+0" will appear and confirm by  button.

Thermostat will go back to main screen and previous work mode.

## 5.5 Control and Heat/Cool settings

This function enables the selection of the controller operating mode:

**HEAT** - thermostat controls heating installations,

**COOL** - thermostat controls cooling installations.

Thermostat is set to heating mode by default. To change the parameter follow the steps below:

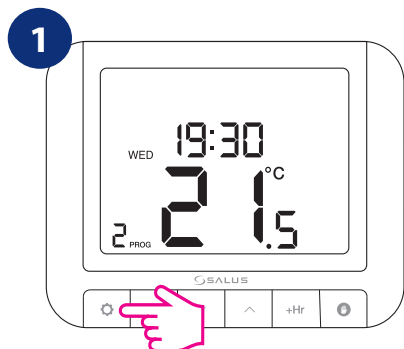

Press .

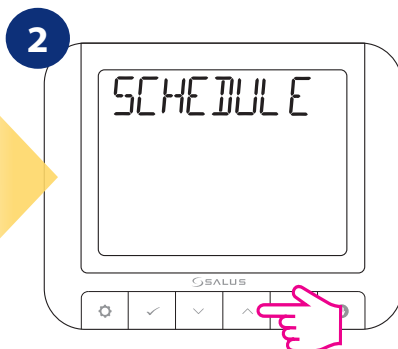

Using  or  move between parameters.

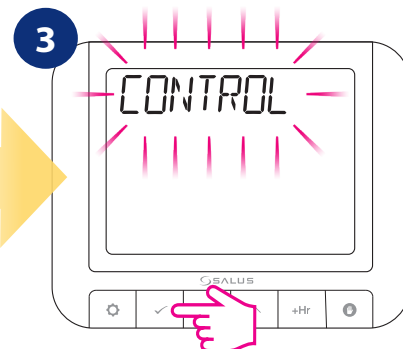

Enter using  button.

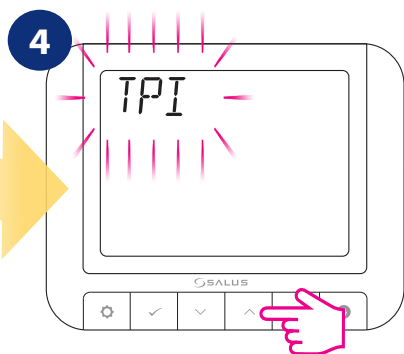



Using  or  move between parameters.

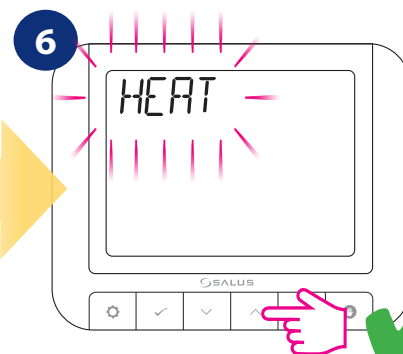

Confirm HEAT / COOL option using  button.



Using  or  move between parameters. Confirm your choice by  button.

## 5.6 OFFSET temperature calibration

In this chapter you will learn how to properly calibrate the temperature in the RT520RF thermostat. Calibration is possible in the range from  $-3.5^{\circ}\text{C}$  to  $3.5^{\circ}\text{C}$  (in steps of  $0.5^{\circ}\text{C}$ ). To calibrate temperature please follow steps below:

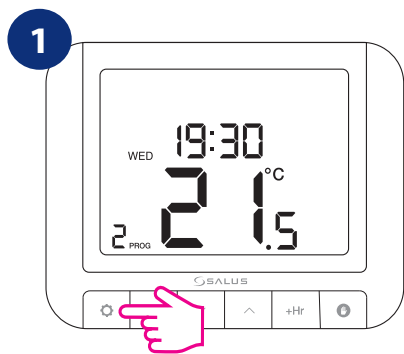

Press .

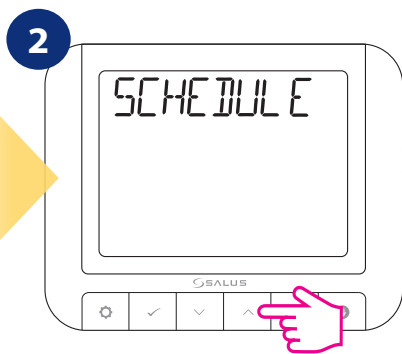

Using  or  move between parameters.

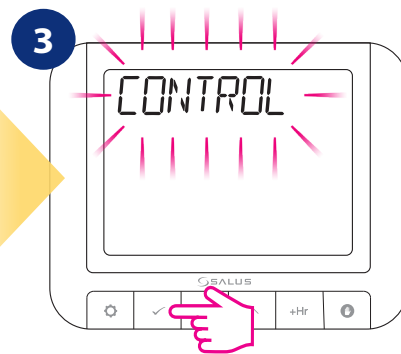

Enter using  button.

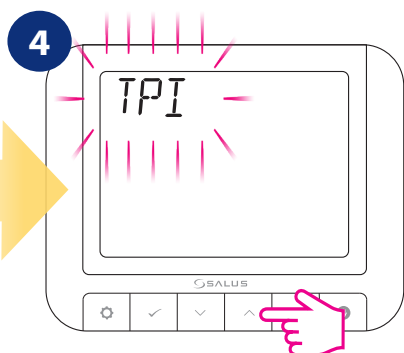



Using  or  move between parameters.

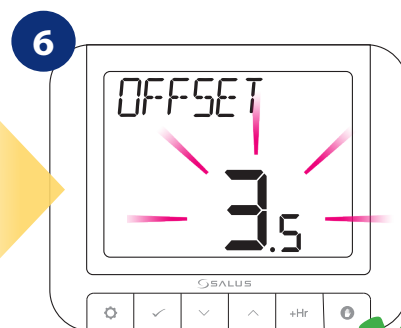

Confirm OFFSET option using  button.



Using  or  calibrate temperature. Calibration is possible in the range from  $-3.5^{\circ}\text{C}$  to  $3.5^{\circ}\text{C}$  (in steps of  $0.5^{\circ}\text{C}$ ) Confirm your choice by  button.

## 5.7 Landlord settings

Landlord settings is a pin code protected feature that allows the landlord to set a service reminder on the thermostat that will warn the tenant when the boiler is due its annual service.

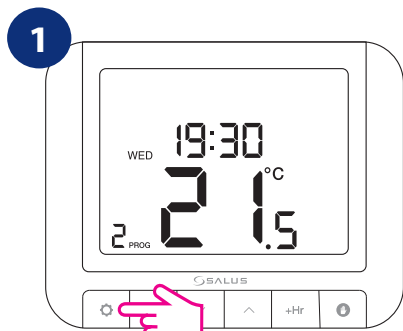

Press .

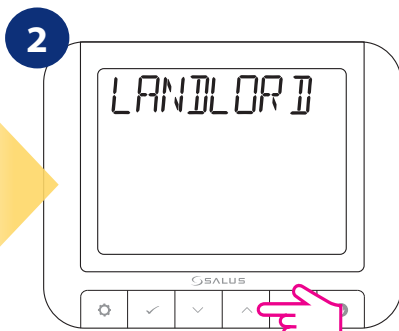

Using or , navigate to Landlord submenu and press .

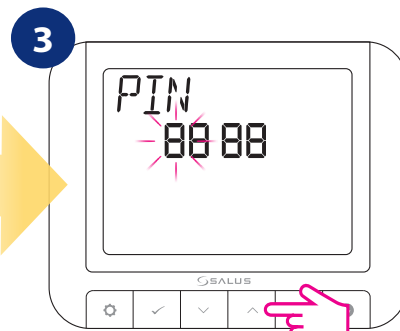

Using or , enter the PIN code number. Press to confirm every digit. **Note:** The first PIN code entry is also the setting of a NEW PIN CODE which must be entered each time to enter the LANDLORD (Admin) menu.

4



**Please remember** to write down your pin code so that you can use the Landlord menu later without any hassle from losing it.



Press .

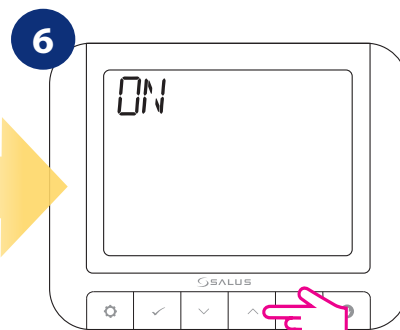

Using or , select ON and press .

7

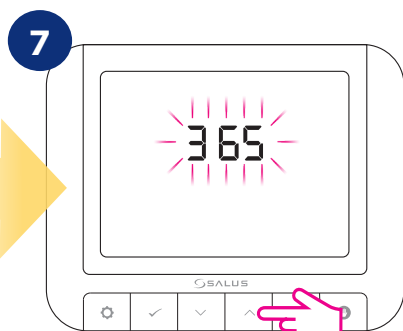

Using or , select the due date and then press .



Using or , select the warning period and then press .

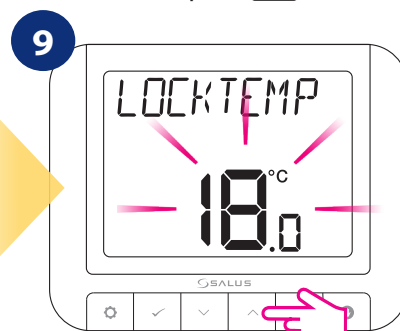

Using or , select the lock temperature and then press .

10

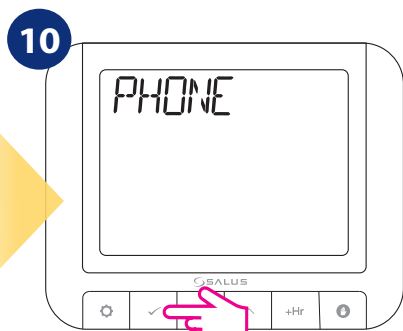

Press .

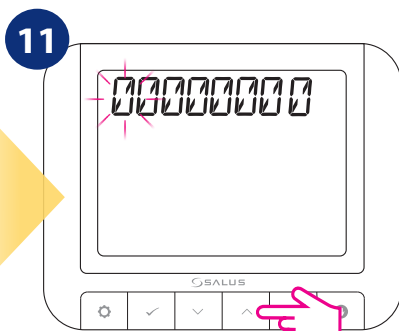

Using or , enter the phone number. Press to confirm every digit.

12



To confirm and exit this option use button. Then use or buttons again to move to the next LANDLORD options (look at the next steps).



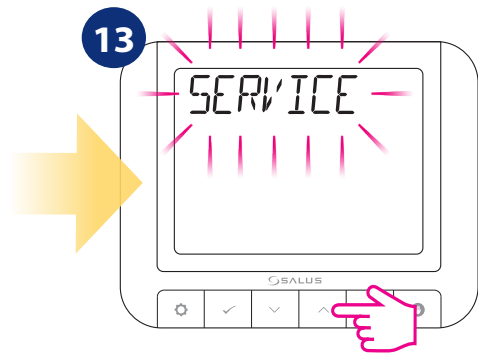

Using  or , move to the next option.



Press .

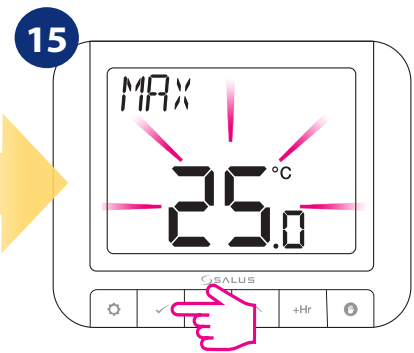

Using  or , select correct MAX temperature setpoint value. Confirm by .

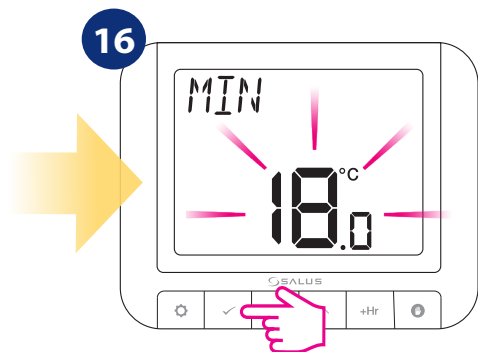

Now, using  or , select correct MIN temperature setpoint value. Confirm by .



Thermostat will go to the next option. Here you can decide if your receiver is allowed to work in manual mode or not. To set it press  button.

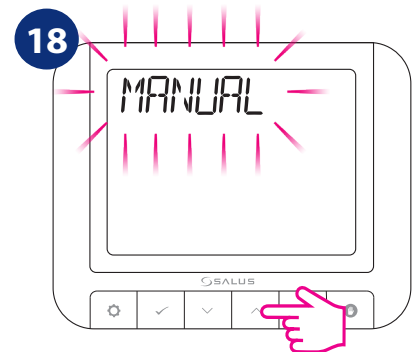

Now, using  or , select proper settings (ON / OFF).

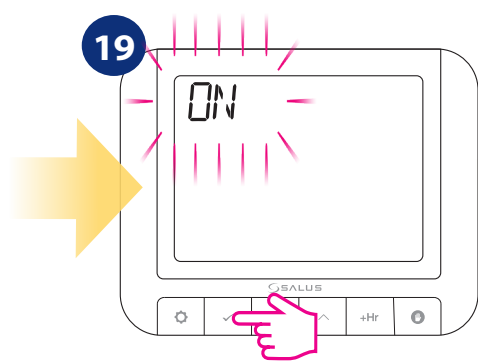

Confirm by .



Thermostat will go back to SERVICE option. To go back to the main screen wait 10 seconds or press  button as long as main screen will be displayed.

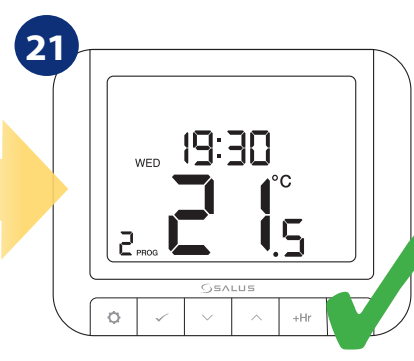

## 5.8 Time/Date

To set time/date follow steps below:

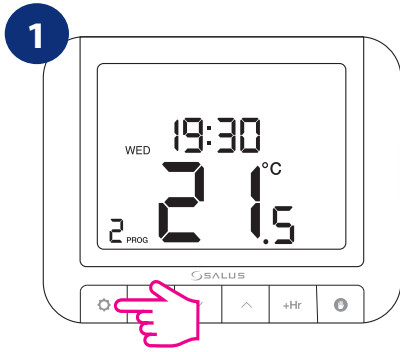

Press .

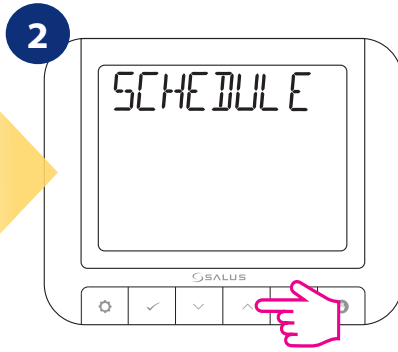

Using or move between parameters.

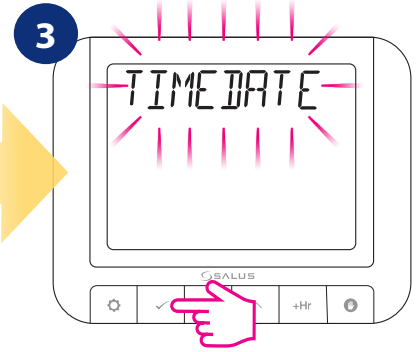

Press to enter Time/Date settings.

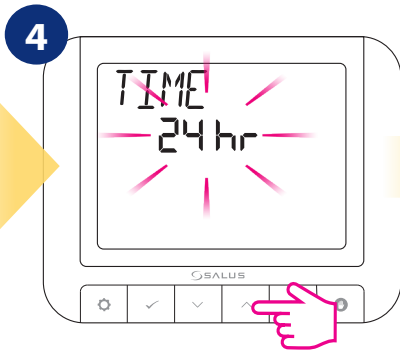

Using or , choose the time format. Press to confirm.

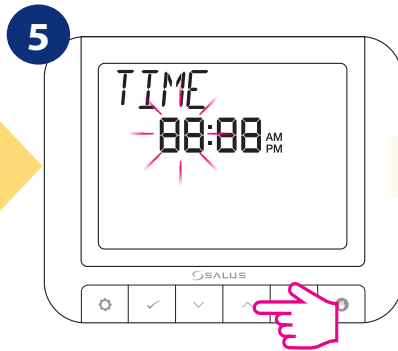

Using or , set the hour and then press .

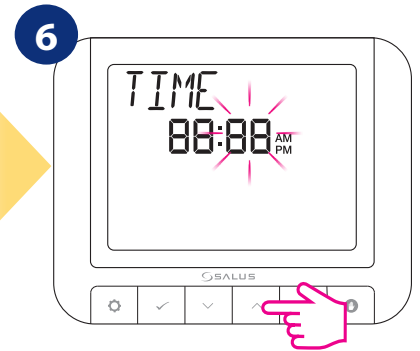

Using or , set the minutes and then press .

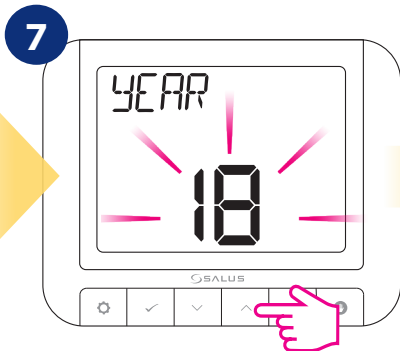

Using or , set the year and then press .

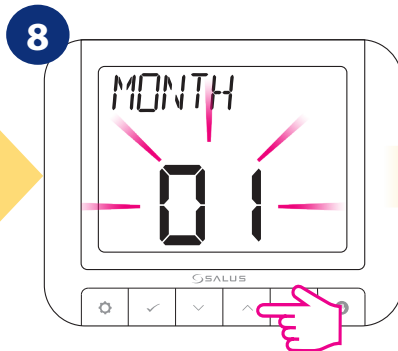

Using or , set the month and then press .

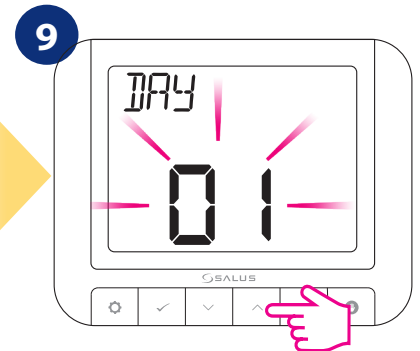

Using or , set the day and then press .

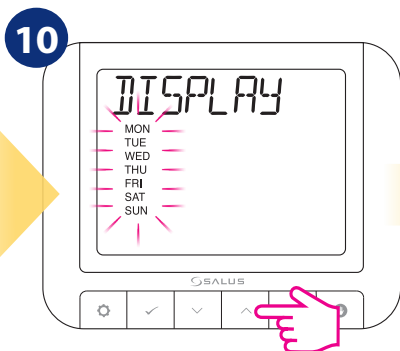

Using or , select the week format. Press to confirm.

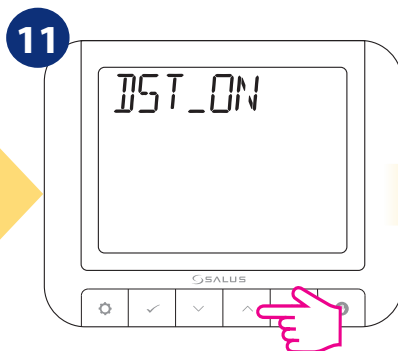

Using or , enable or disable DST (Daylight Saving Time). Press to confirm.

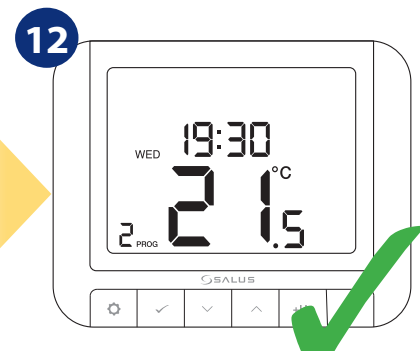

Thermostat will go to the main screen with saving all the settings.

## 5.9 Holiday mode

Holiday mode is a special program temperature setpoint which thermostat will maintain for specified days. How to set **HOLIDAY MODE**:

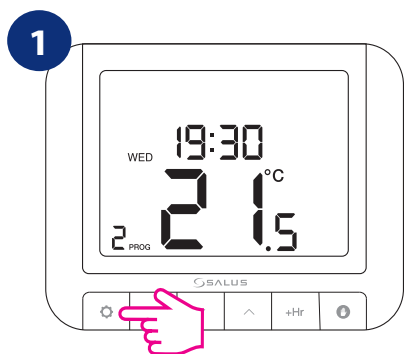

Press .

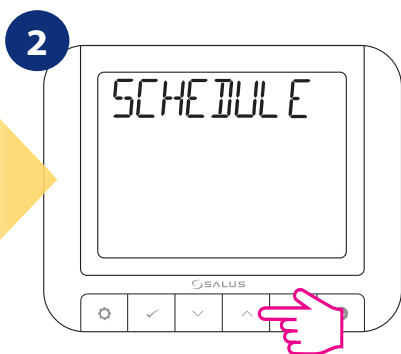

Using or move between parameters.



Press to enter holiday mode settings.

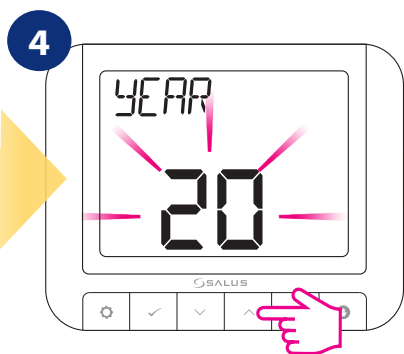

Using or , set the year and then press .

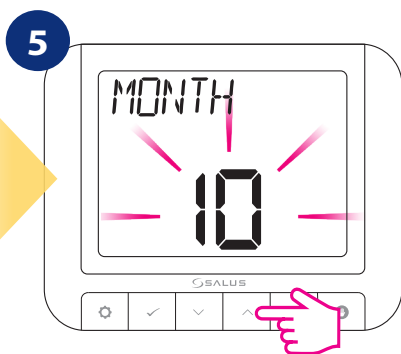

Using or , set the month and then press .

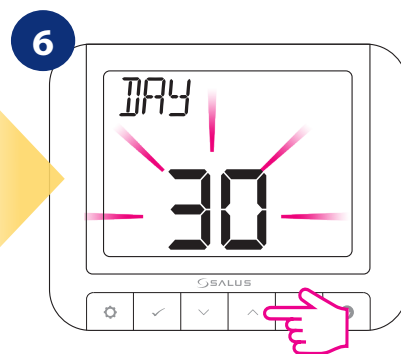

Using or , set the day and then press .

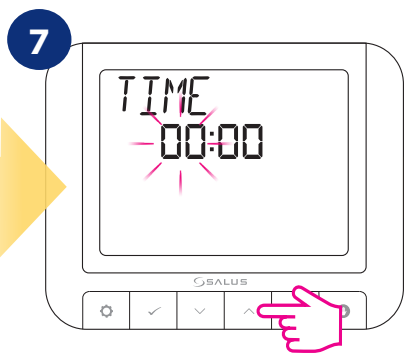

Using or , set the hour and then press .



Using or , set the minutes and then press .

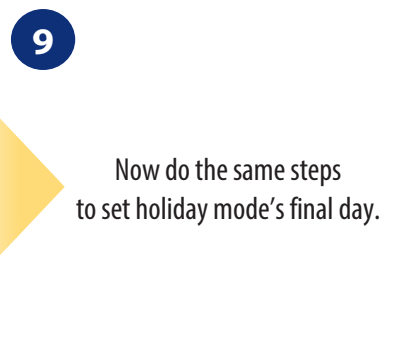

Now do the same steps to set holiday mode's final day.

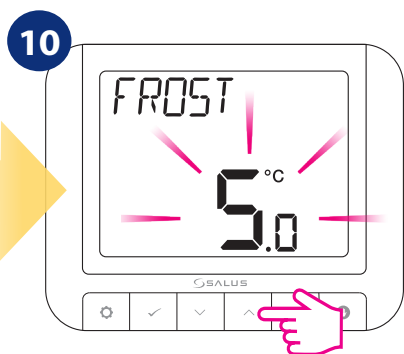

Using or , set the temperature which should be maintained during holiday mode and then press .

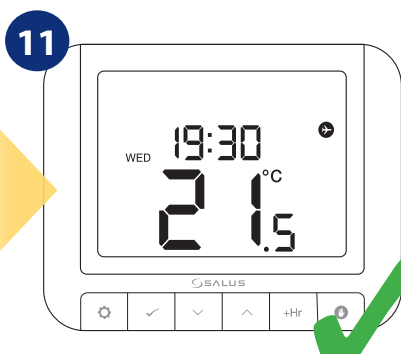

According to set period of time the plane icon will appear on the main screen and thermostat is working in holiday mode.

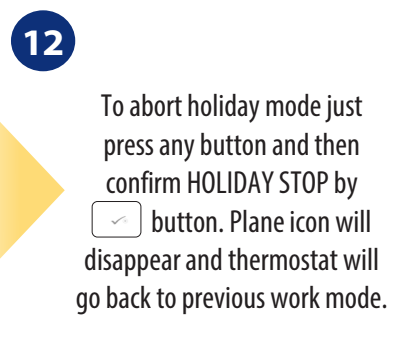

To abort holiday mode just press any button and then confirm HOLIDAY STOP by button. Plane icon will disappear and thermostat will go back to previous work mode.

## 5.10 Language

To choose language follow steps below:

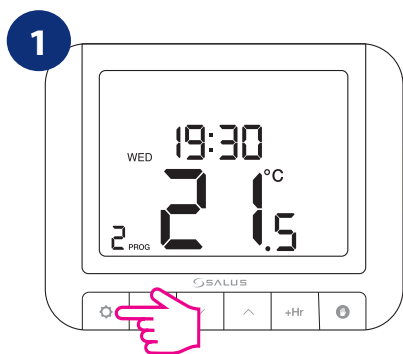

Press .

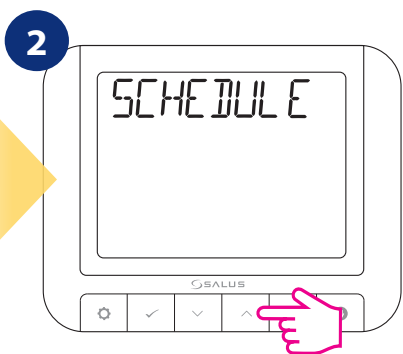



Using  or  move between parameters.

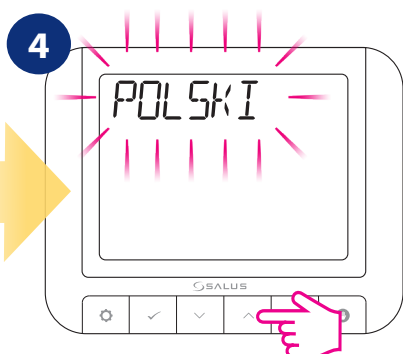

Press  to enter language settings.



Using  or  choose your language.

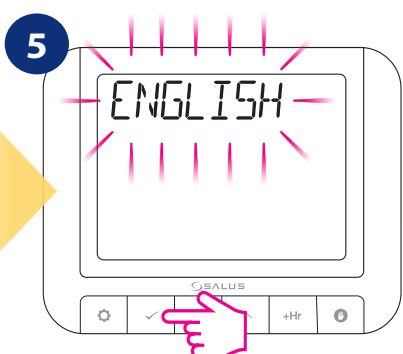

Press  to confirm.

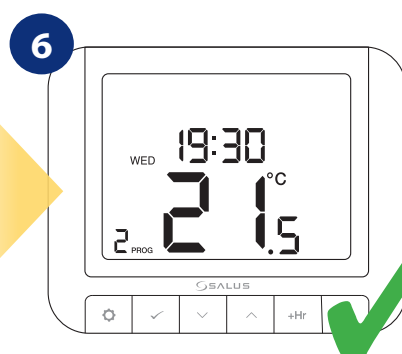

Thermostat will go to the main screen with saving the changes.

## 6. RT520RF thermostat pairing with the receiver

The word PAIRING in the user settings means the function of synchronizing the transmitter with the receiver again, if it has been removed.



### WARNING!

**IN THE SET RT520RF THE THERMOSTAT IS FACTORY PAIRED WITH THE RECEIVER!**

In order to pair the devices correctly, you must first prepare the receiver for synchronization!

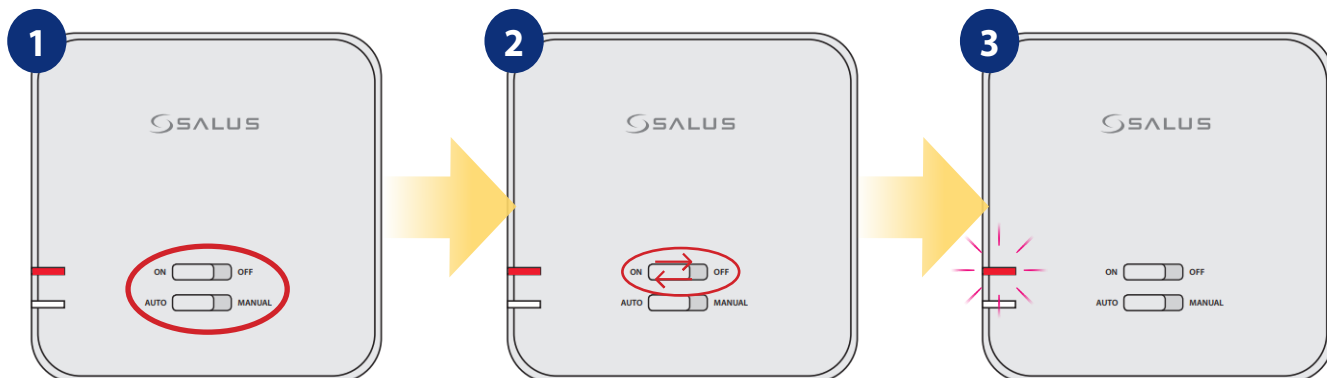



If you want to re-pair the devices with each other, make sure that the receiver is disconnected from the power supply and the switches on it are in the AUTO and ON positions. Then connect the receiver to the power supply and wait for the red diode to glow continuously.

Move the top switch to the OFF position with a quick motion and back to the ON position.

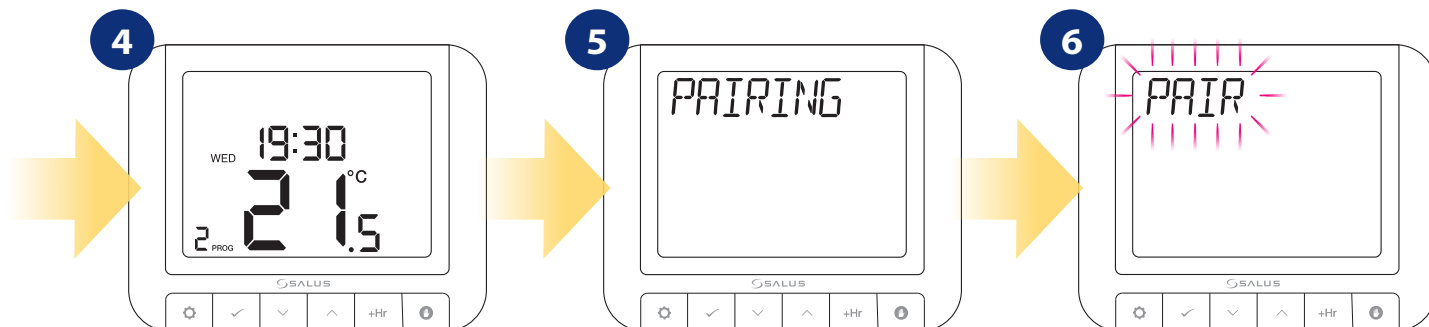
The red LED will start blinking, which will confirm that the receiver has entered the pairing mode.



Press .

Using  or , navigate to PAIRING submenu and press .

Using  or , select PAIR and press .

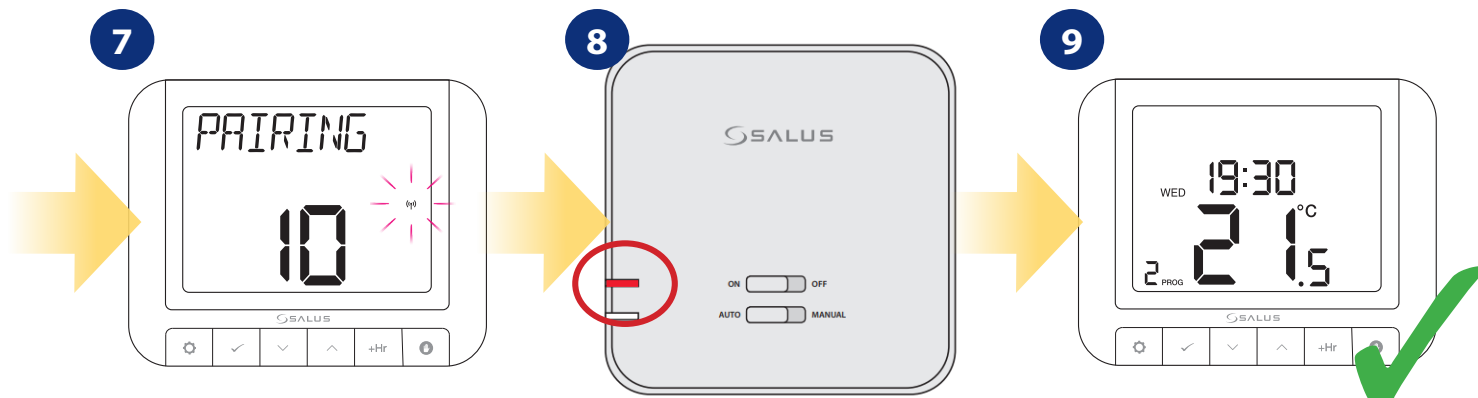

The pairing process takes up to 10 minutes.

When the red diode on the receiver lights up continuously, the devices have been paired on a new frequency.



After all, thermostat will go back to the main screen.

## 7. Test the pairing process

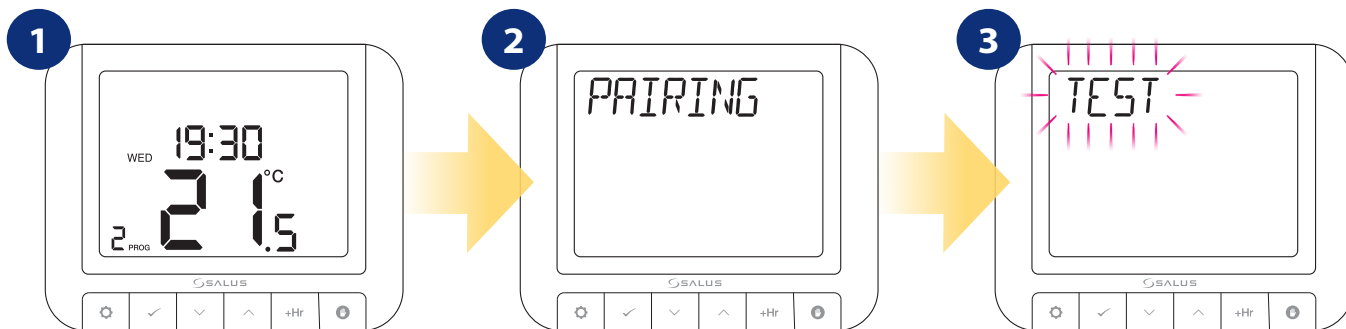
It is important to place the receiver and transmitter in places where nothing interferes with the radio signal. The range of communication between the transmitter and the receiver in an open area is up to 60m. The radio transmission is influenced by many factors that can shorten the working distance, such as thick walls, drywall covered with aluminum foil, metal objects such as cabinets, general radio interference, etc. However, the range is sufficient for most domestic use. It is recommended to test the radio transmission between devices before mounting the regulator on the wall. The test can be performed by changing the set temperature, i.e. by activating or deactivating the heating.



Press .

Using  or , navigate to PAIRING submenu and press .

Using  or , select TEST and press .

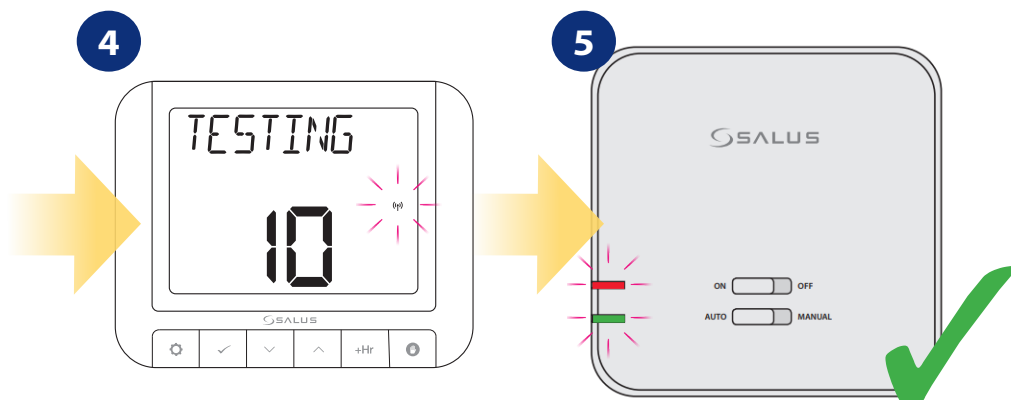

The testing process takes up to 10 minutes.

The red LED and the green LED on the receiver will begin to flash.

## 8. Factory Reset

To RESET RT520RF thermostat to it's factory default settings please follow steps below:

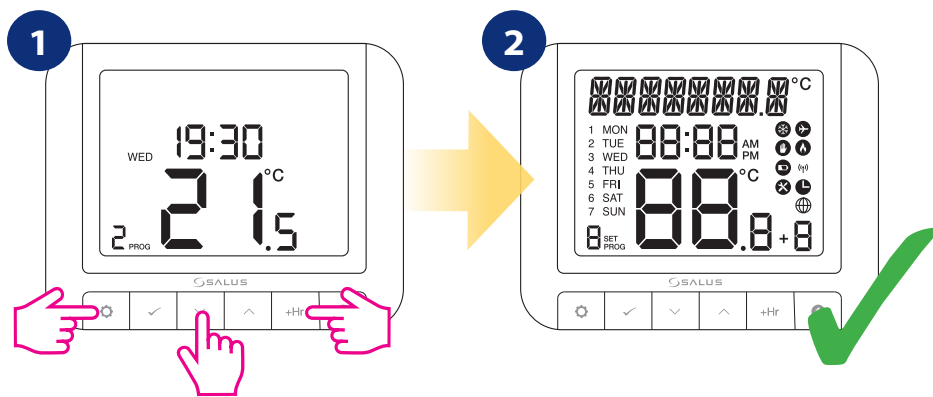

To reset the thermostat press and hold together + + buttons for 5 seconds.

Thermostat has been reseted.  
**PLEASE NOTE:** User settings will not be deleted.

## 9. Error codes



Thermostat will display errors only when it's connected to the boiler by OPENTHERM terminals (A / B). Please refer then to boiler manual. Each boiler can have different error codes.

## 10. Battery change

Turn the thermostat over so that the back is in front of you. Now look at the picture below:

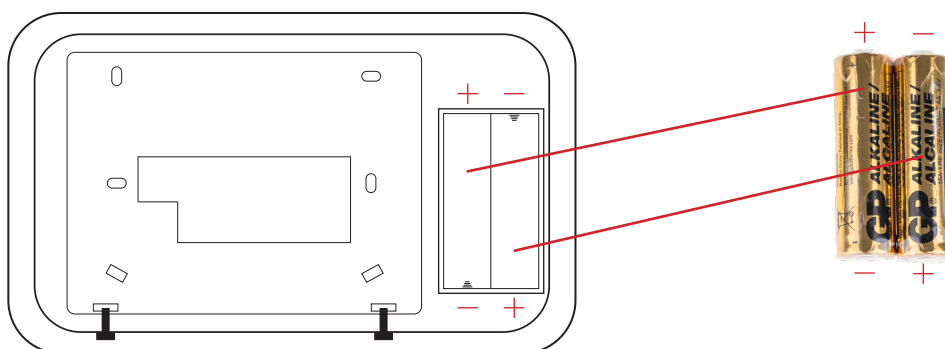

INSERT THE BATTERIES, PAYING ATTENTION TO THEIR POLARITY!

## 11. Cleaning and Maintenance

The **RT520RF thermostat** requires no special maintenance. Periodically, the outer casing can be wiped clean using a dry cloth (please **DO NOT** use solvents, polishes, detergents or abrasive cleaners, as these can damage the thermostat). There are no user serviceable parts within the unit; any servicing or repairs could only be carried out by **Salus Controls** or their appointed agents.

## 12. Technical Informations

Power supply	2 x AA batteries
Receiver rating max	16 (5) A
Output signal	OpenTherm or voltage free COM/NO
Temperature range	5 - 33.0°C
Display temperature accuracy	0.1°C or 0.5°C
Control algorithm	TPI or Hysteresis: $\pm 0.25^{\circ}\text{C}$ or $\pm 0.5^{\circ}\text{C}$
Communication	Wireless, 868Mhz
Dimension [mm]	Transmitter: 118 x 95 x 26 Receiver: 96 x 96 x 27

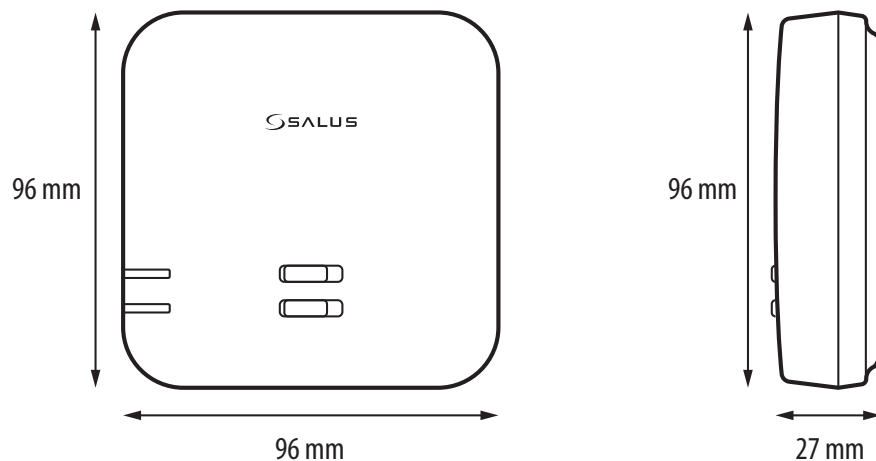
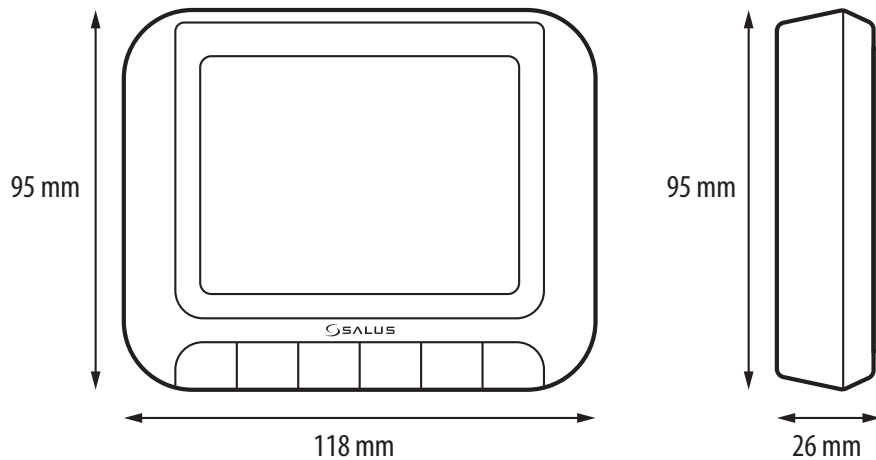



### 13. Warranty

SALUS CONTROLS warrants this product to be free from any defects in material or workmanship and to perform as specified for a period of five years from the date of installation. SALUS CONTROLS reserves the sole responsibility for breach of this warranty by repairing or replacing the defective product. This product includes software that matches the distributor's identification at the time of sale. The manufacturer / distributor provides a guarantee covering all functions and specifics of the product in accordance with this marking. The distributor's warranty does not cover the correct operation of the functions and features available as a result of a product software update.

The full warranty conditions are available at [www.salus-controls.eu](http://www.salus-controls.eu)

<p><b>Customer Name:</b> .....</p> <p><b>Customer Address:</b> .....</p> <p>..... <b>Post Code:</b> .....</p> <p><b>Tel No:</b> ..... <b>Email:</b> .....</p>
<p><b>Company Name:</b> .....</p> <p><b>Tel No:</b> ..... <b>Email:</b> .....</p> <p><b>Installation Date:</b> .....</p> <p><b>Installer Name:</b> .....</p> <p><b>Installer Signature:</b> .....</p>

PRODUCER:

SALUS Controls Plc Units 8-10 Northfield  
Business Park Forge Way, Parkgate,  
Rotherham S60 1SD, United Kingdom



[www.saluscontrols.com](http://www.saluscontrols.com)

SALUS Controls is a member of the Computime Group.

Maintaining a policy of continuous product development SALUS Controls plc reserve the right to change specification, design and materials of products listed in this brochure without prior notice.

Ver. 6

Issued: 14 IV 2021

Soft version: 2.3

