

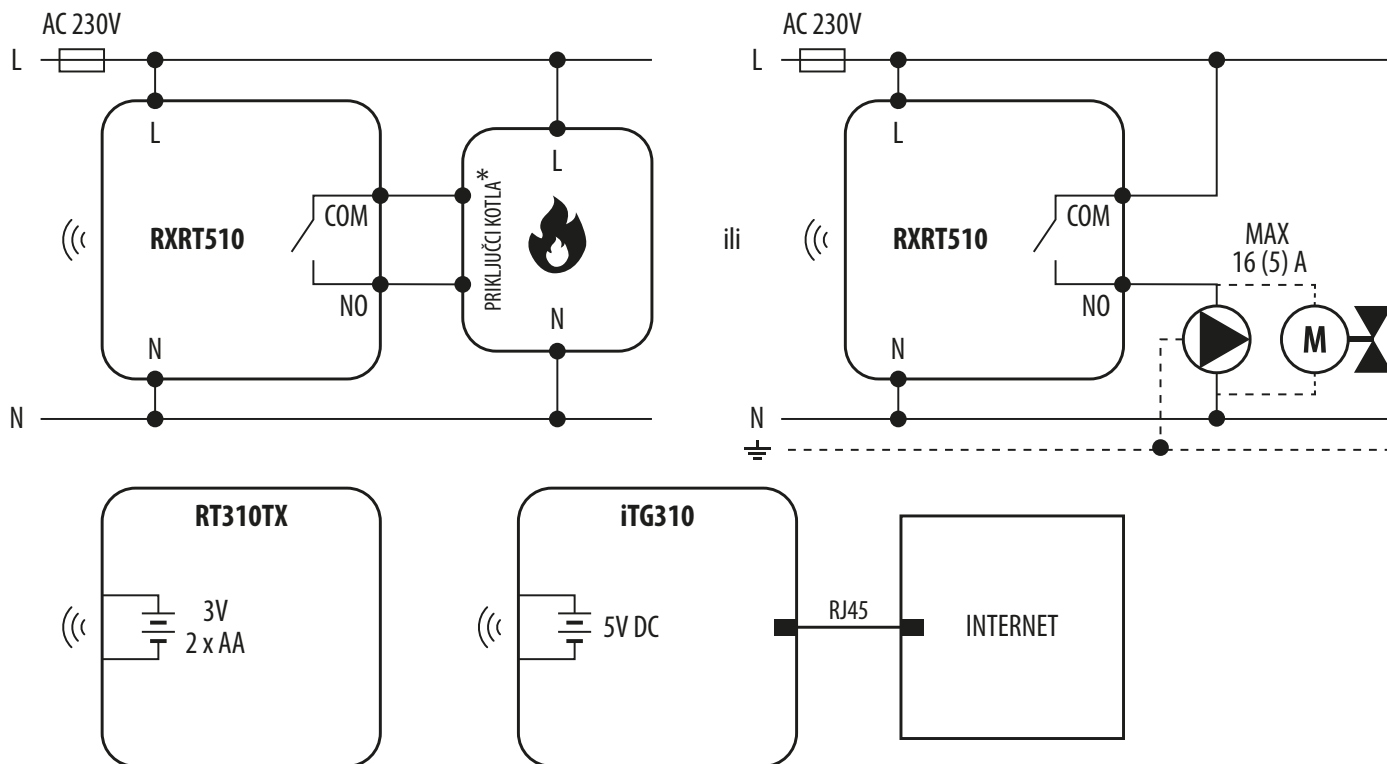















RT310i - TECHNICKÉ ÚDAJE



LEGENDA

	Napájení bateriemi		Bezdrátová komunikace
L, N	Napájení 230V AC		Čerpadlo
	Pojistka		Ovladač ventilu
COM, NO, NC	Výstup bez napětí		Teplotní čidlo
S, S1, S2	Vstupní svorky		Třístupňový ventilátor 230V AC
SL	Napětí 230V AC		Žárovka nebo jiné zatížení
	Kontakt bez napětí otevřený		Termoelektrický pohon
	Kontakt bez napětí zavřený		Časový programátor
	Přepínač NC / COM / NO		Vnější kontakt normálně otevřený
	Kotel - Připojení kotle - Kontakty kotle pro ON / OFF termostat (podle instalační příručky kotle)		Měnič napětí