

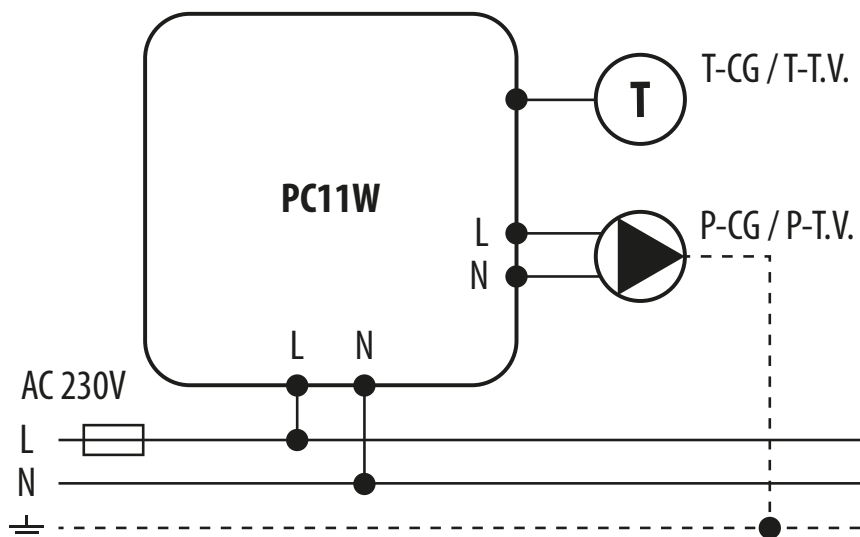















PC11W

Dijagrami žičanog povezivanja



OPIS IKONA

	Baterijski napajan		Bežična komunikacija
L, N	230V AC napajanje		Pumpa
	Osigurač		Ventil aktuatora
COM, NO, NC	Bez-naponski izlaz		Senzor temperature
S, S1, S2	Ulazni terminali		Ventilator sa 3 brzine
SL	230V AC naponski izlaz		Osvetljenje ili neko drugo opterećenje
	Normalno otvoren kontakt NO		Termoelektrični aktuator
	Normalno zatvoren kontakt NC		Vremenski programator
	NO/COM/NC prekidač		Dodatni normalno otvoren kontakt
	Kotao - priključci na kotlu - priključci kotla za ON/OFF termostat (prema uputstvima kotla)		Transformator (naponski konverter)