



Manual

PRODUCER:
SALUS Controls Plc
Units 8-10 Northfield Business Park
Forge Way, Parkgate, Rotherham S60
1SD, United Kingdom



www.saluscontrols.com

SALUS Controls is a member of the Computime Group.

Maintaining a policy of continuous product development SALUS Controls plc reserve the right to change specification, design and materials of products listed in this brochure without prior notice.



Introduction

A programmable timers EP110, EP210, EP310 are used to switch ON/OFF the heating system, the hot water or any electronical device like pumps or lights as needed. It works by controlling with programmed schedules (24H or 5-2 schedule types) which contain 3 time programs each.

Product Compliance

EU Directives: 2014/30/EU, 2014/35/EU and 2011/65/EU.
Please check www.saluslegal.com for the full information.

Safety Information

Use in accordance with the EU and national regulations. For indoor use only. Keep your device completely dry. This product must be installed by a competent person and in accordance with all the EU and national regulations.

Technical data

	EP110	EP210	EP310
Power Supply	230V AC	230V AC	230V AC
Max load	3 (1) A	3 (1) A	3 (1) A
Output	NO / COM / NC voltage free	2 x SPDT 230V AC	3 x SPDT 230V AC
Number of channels	1	2	3
Dimensions [mm]	120 x 98 x 27	120 x 98 x 27	120 x 98 x 27

Buttons functions

Button	Function
MODE	Select operating mode (ON, ONCE, AUTO, ADV, OFF)
+Hr	Activate/deactivate BOOST function
	Turn on the LCD backlight
	Press for 3 sec to activate HOLIDAY mode
	Increases the selected setting
	Decreases the selected setting
SELECT	Select a clock or programme setting
SET	Sets a clock or programme setting
RESET	Reset to Factory settings

LCD display icon description

EP110

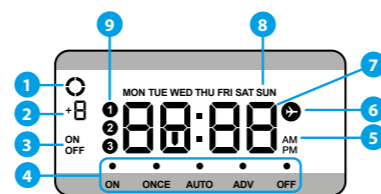

1. Device operation (animated icon)
2. Number of hours for the BOOST function
3. ON/OFF indicator
4. Work mode
5. AM/PM
6. Holiday mode
7. Clock
8. The day of the week
9. Program number

EP210

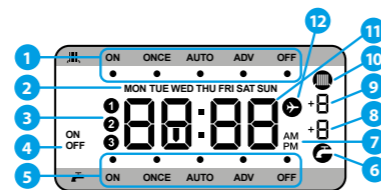

1. Zone I operation mode
2. Day of the week
3. Program number
4. ON/OFF indicator
5. Zone II operation mode
6. Zone II work status
7. AM/PM
8. Number of hours for the BOOST function for Zone II
9. Number of hours for the BOOST function for Zone I
10. Zone I work status
11. Clock
12. Holiday mode

EP310

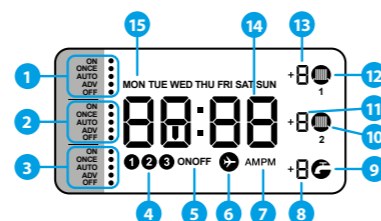

1. Zone I operation mode
2. Zone II operation mode
3. Zone III operation mode
4. Program number
5. ON/OFF indicator
6. Holiday mode
7. AM/PM
8. Number of hours for the BOOST function for Zone III
9. Zone III work status
10. Zone I work status
11. Number of hours for the BOOST function for Zone II
12. Zone II work status
13. Number of hours for the BOOST function for Zone I
14. Clock
15. Day of the week

Jumpers settings

The parameters can be changed using the jumpers on the back of the device.

Note: Disconnect power supply before working with the device.

EP110 / EP310	EP210	Description
-	P	System selection: P - systems work separately G - HW dependent on CH (CH switching causes switching HW)
5-2	G	Schedule mode selection: • business days + weekend (5-2) • each day separately (24 h)
wył.	wł.	Memory support

Note: After changing the settings, it is necessary to reset the device using RESET button.

Wiring diagram

All wire connectors are located on the back of the device. To remove the cover, loose two screws located at the bottom of the device and then remove the back of the housing.

Note: Disconnect power supply before working with the device.

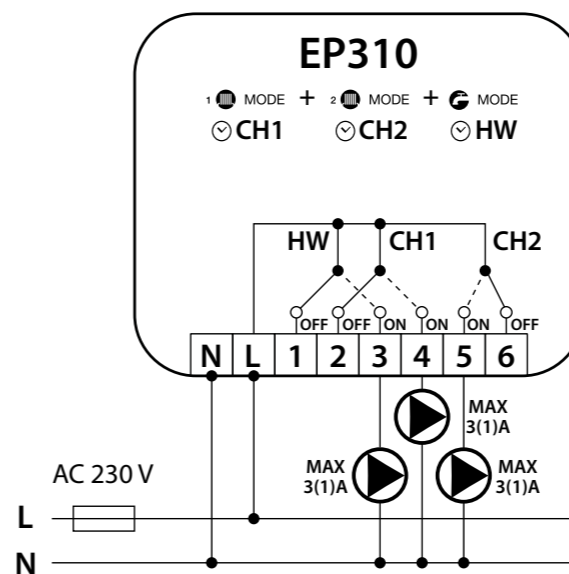
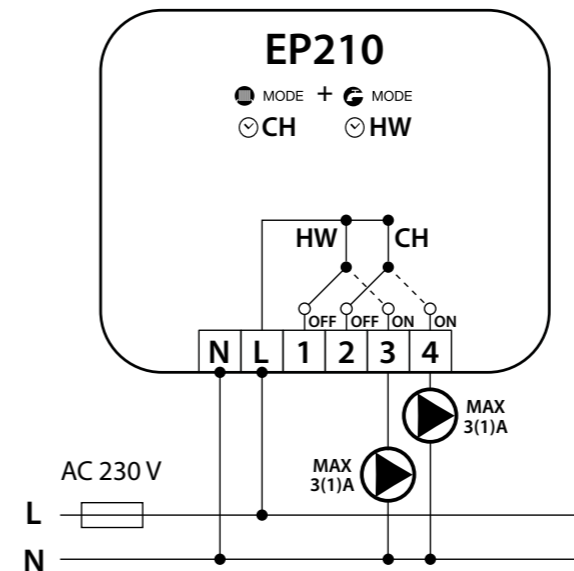
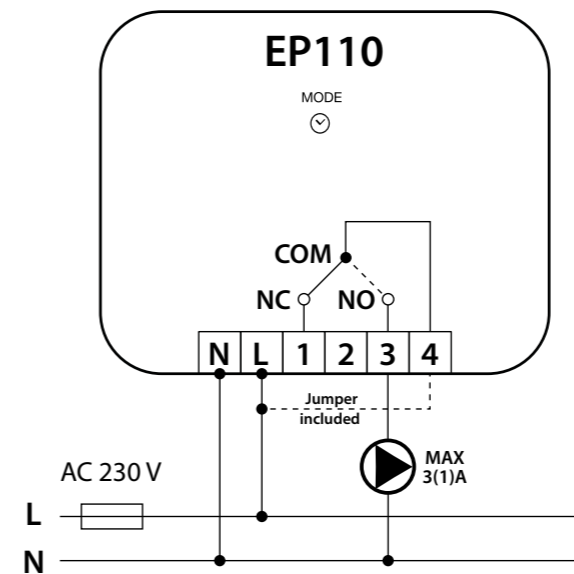

Setting time and date

1. Hold SELECT and SET buttons at the same time for 3 seconds. Display shows 12:00.
2. Press ^ or v button to choose the time format (12hr or 24hr). Display shows 12 hr.
3. Confirm selection using SELECT button. Display shows 24 hr.
4. Press ^ or v button to set hour. Display shows 00:00.
5. Confirm selection using SELECT button. Display shows 13:00.
6. Press ^ or v button to set minutes. Display shows 13:00.
7. Confirm selection using SELECT button. Display shows 13:56.
8. Press ^ or v button to set year. Display shows 4 16.
9. Wybór zatwierdz przyciskiem SELECT. Display shows 4 17.
10. Press ^ or v button to set month. Display shows m 01.
11. Confirm selection using SELECT button. Display shows m 11.
12. Press ^ or v button to set day. Display shows d 01.
13. Confirm selection using SELECT button. Display shows d 15.
14. Press ^ or v button to set the summer time change function DST*. Press the SET button to end the time/date setting. Display shows d 5t.

*When the Daylight Saving Time (DST) function is on (ON), controller will automatically change the time from winter to summer.

Operation modes

There are 5 different work modes available. Using **MODE** button, you can change modes directly according to the following sequence:

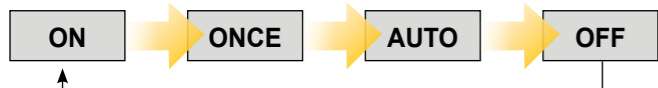

ON mode

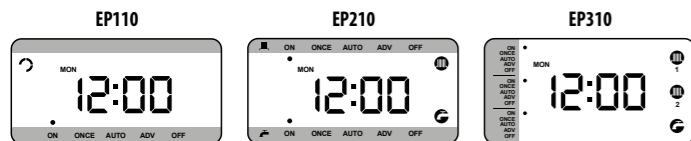

Controller works continuously:

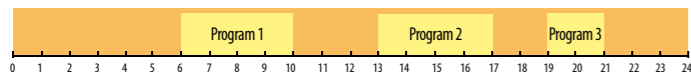

ONCE mode

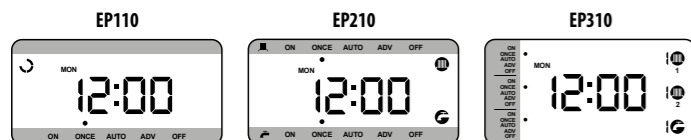

Controller works from the beginning of Program 1 to the end of Program 3:

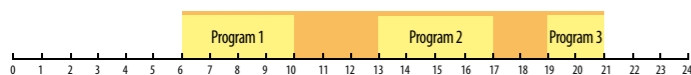

AUTO mode



Controller works according to previously defined programs:

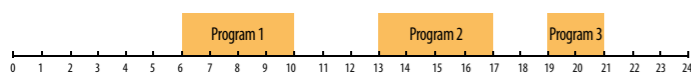

ADV mode

The ADV mode can be activated if the ONCE or AUTO mode is selected when it is activated.



To turn the ADV mode on or off, press the **MODE** button for 3 seconds. The mode of operation of the mode has been presented in the chart below

Enabling the ADV function, when all programs are inactive, will turn on selected channel until the end of the nearest program.

Enabling the ADV function, when the program is active, will turn off selected channel until the end of the nearest program.

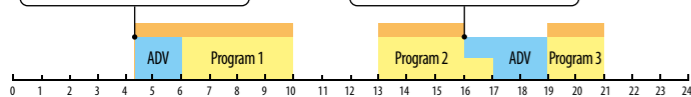

OFF mode

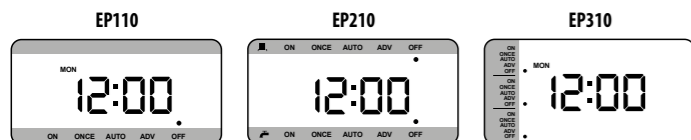

Controller is turned off.

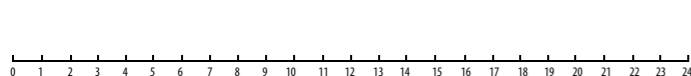

Programming EP110 controller

You can create 3 independent time schedules. There are 2 work models to choose from:

- business days + weekend (5-2)
- each day separately (24 hours)

Controller works by default in working days + weekend mode (5-2).

To set each day separately (24 hours), change the jumper position according to the diagram on previous page.

1. Press **MODE** button.
2. Press **^** or **v** button to choose the days you want to program.
3. Confirm selection using **SELECT** button.
4. Press **^** or **v** button to set start time (hour) of the program 1.
5. Confirm selection using **SELECT** button.
6. Press **^** or **v** button to set start time (minutes) of the program 1.
7. Confirm selection using **SELECT** button.
8. Press **^** or **v** button to set end time (hour) of the program 1.
9. Confirm selection using **SELECT** button.
10. Press **^** or **v** button to set end time (minutes) of the program 1.
11. Confirm selection using **SELECT** button.
12. Controller will automatically go to the settings of program 2. Follow steps 4 - 11 to set further programs. Press **SET** button to complete programming.

Programming EP210/EP310 controller

You can create 3 independent time schedules for each zone. There are 2 work models to choose from:

- business days + weekend (5-2)
- each day separately (24 hours)

Controller works by default in working days + weekend mode (5-2).

To set each day separately (24 hours), change the jumper position according to the diagram on previous page.

1. Press **MODE** button.
2. Press **^** or **v** button to select a zone or zones and days, which you want to program.
3. Confirm selection using **SELECT** button.
4. Press **^** or **v** button to set start time (hour) of the program 1.
5. Confirm selection using **SELECT** button.
6. Press **^** or **v** button to set start time (minutes) of the program 1.
7. Confirm selection using **SELECT** button.
8. Press **^** or **v** button to set end time (hour) of the program 1.
9. Confirm selection using **SELECT** button.
10. Press **^** or **v** button to set end time (minutes) of the program 1.
11. Confirm selection using **SELECT** button.
12. Controller will automatically go to the settings of program 2. Follow steps 4 - 11 to set further programs. Press **SET** button to complete programming.

HOLIDAY mode

Holiday mode is used to disable all controller outputs for a specified number of days (up to 31 days). When HOLIDAYS mode is active, aircraft icon will appear on the display.

1. Press **MODE** button.
2. Press **^** or **v** button to set HOLIDAY mode duration (in days).
3. Press **SET** button to confirm selection.
4. Press **SET** button to confirm selection.

Disabling the Holiday mode

1. Press **MODE** button.
2. Press **MODE** button for 3 seconds to return to normal mode.

BOOST Function

BOOST function extends the active program time to 1-9 hours. Press **+HR** button to activate BOOST mode (each press of the button extends the active program by 1 hour).



Factory Settings

If you made a mistake, want to change controller parameters or return to its factory settings, you can reset controller with **RESET** button.

Note: RESET button will permanently delete your existing settings.

