

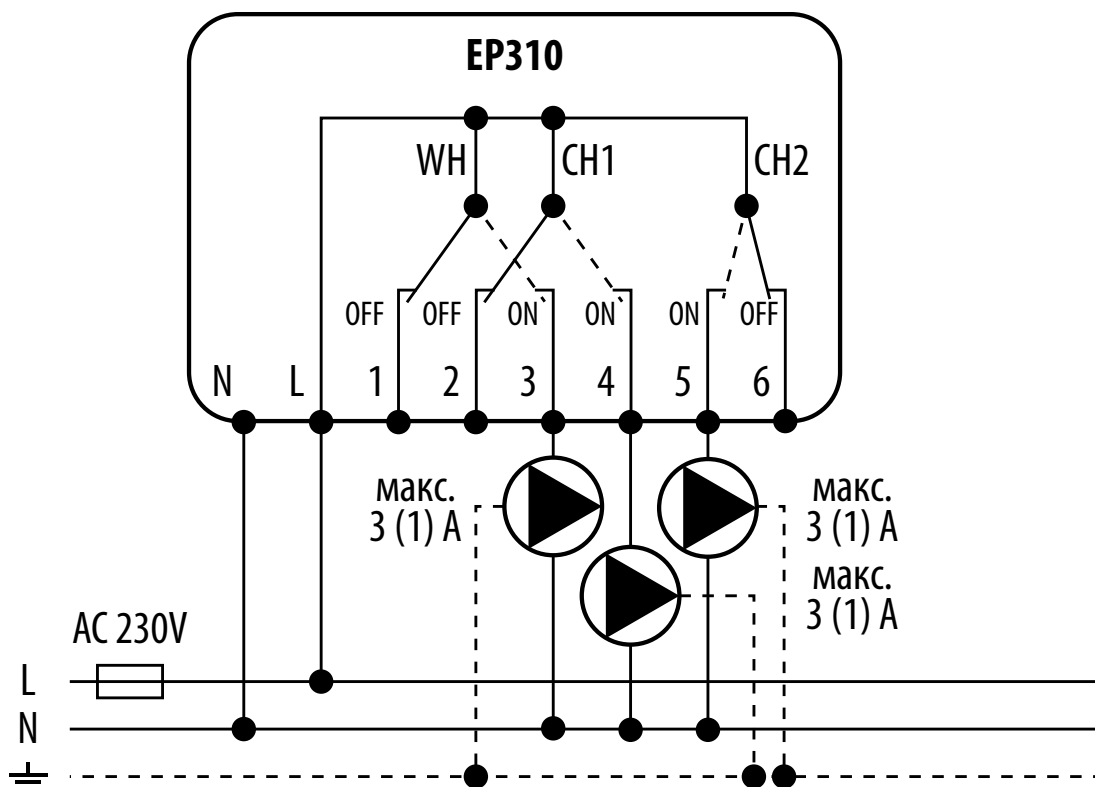











EP310 - Схема на свързване.



ЛЕГЕНДА

	Захранване батерии		Безжична комуникация
L, N	Захранващо напрежение 230V AC		Помпа
	Предпазител		Вентил с ел. задвижка
COM, NO, NC	Безнапрежени контакти		Темп. сензор
S, S1, S2	Контактни входове		Вентилатор - 3 скорости 230V AC
SL	Напрежен изход 230 V AC		Ел. крушка или друг товар
	Нормално отворен контакт		Термо-задвижка
	Нормално затворен контакт		Таймер
	Превключващ контакт NC/COM/NO		Външен нормално отворен контакт
	Котел - Свързване на котел* - свързване с термостат ON/OFF (в зависимост от котела)		Трансформатор