



Manual



SALUS Controls Plc
Units 8-10 Northfield Business Park
Forge Way, Parkgate
Rotherham, S60 1SD
United Kingdom



www.saluscontrols.com

SALUS Controls is a member of the Computime Group.

Maintaining a policy of continuous product development SALUS Controls plc reserve the right to change specification, design and materials of products listed in this brochure without prior notice.

AUG 2021
V15



Control box description

1. Cartridge fuse 5 x 20 mm T2A
2. Power supply*
3. NSB (Night Set Back reduction) function

4. Actuators output connections (AC 230V)
5. Thermostats input connections
6. CB500X extension input

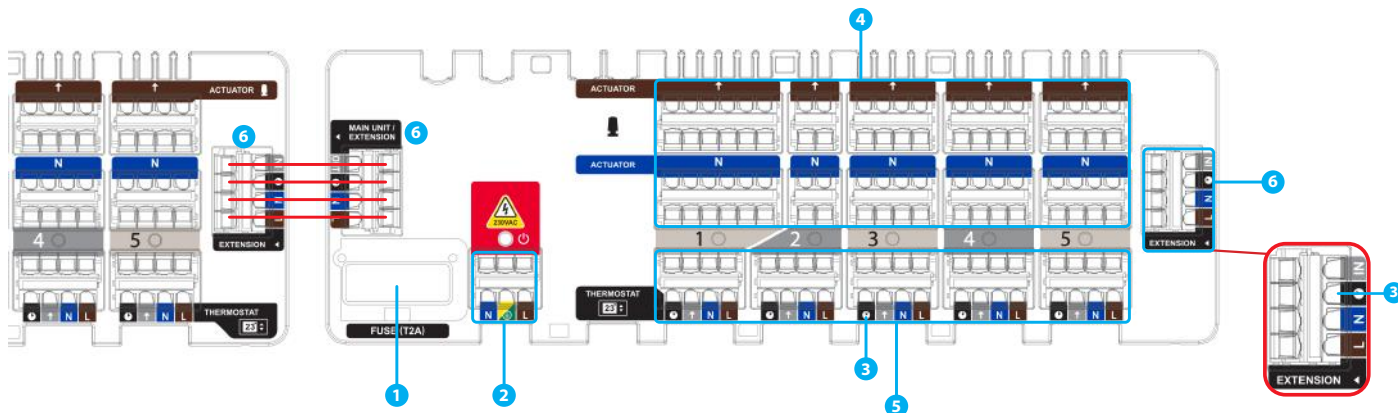

*** WARNING! DO NOT connect power supply to the CB500X power supply input when it is connected together with CB500. CB500X power supply input have to be used only when control box extension works as standalone device.**

Introduction

The CB500X extension module control box is an element of the underfloor heating / cooling control system. The control box allows you to control 5 different zones. Number of controlled zones can be increased up to 15 zones by connecting CB500X extension modules to the CB500 unit which is equipped with a module system that controls the source of heating and cooling. Each individual zone can be operated by one thermostat. Thermostats which require 230V power supply has to be powered directly from control box. The spring clamps provide quick and convenient wiring connections. The control box is designed to work with NC (normally-closed) type actuators. It is recommended to mount it on a surface or on a DIN rail.

Product compliance

This product complies with the essential requirements and other relevant provisions of the following EU Directives: EMC 2014/30/EU, Low Voltage Directive LVD 2014/35/EU and RoHS directive 2011/65/EU. The full text of the EU Declaration of Conformity is available at the following internet address: www.saluslegal.com.

Safety information

Use in accordance with current national and EU regulations. Device is intended for indoor use only in dry conditions. Product for indoor use only. Installation must be carried out by a qualified person in accordance to current national and EU regulations. Before attempting to setup and install, make sure that the devices is not connected to any power source. Installation must be carried out by a qualified person. Incorrect installation may cause damage to the devices. The CB500X should not be installed in areas where it may be exposed to water or damp conditions.

Technical Information

Power Supply	230 V AC
Total Load Max	1 A
Outputs	Actuators (AC 230V)
Dimensions [mm]	270 x 110 x 55

1. Fuse



Note: Replacement of the fuse to be carried out only when the control box is disconnected from power supply (230 V ~).

Main fuse is located under the housing cover next to power supply terminals and secures the control box and the devices connected to it. Use ceramic tube slow blow 250 V ROHS fuses (5x20 mm) with nominal max current 2A. To replace fuse remove the fuse holder with a flat screwdriver and pull out the fuse.

2. Power Supply

Power supply for control box is 230 V ~ 50Hz.

Three wire installation should be made in accordance with the current applicable regulations.



The red LED will illuminate indicating that the control box is connected to the power supply.

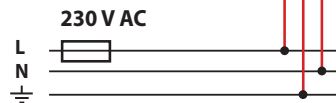
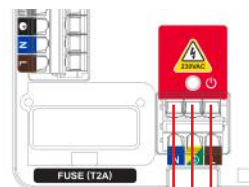

3. NSB (Night Set Back reduction) function

The NSB (Night Set Back) function enables you automatically reduce the setpoint temperature on non-programmable thermostats via programmable thermostat connected to the same control box or an extension module. NSB function changes comfort to economic setpoint temperatures for each thermostat individually. The programmable thermostat, e.g. installed in the living room, sends a signal to the non-programmable thermostats through a control box (by wires). Then, the non-programmable thermostats automatically reduce the setpoint temperature according to the value set on them. The NSB terminal is marked with the clock icon - all NSB terminals are connected together within control box. The NSB function works only in a 4-wire installations (see connection diagrams).

4. Actuators connection

Actuators wires should be plugged into the spring clamps of the respective zones. Maximum current load for each zone is designed to handle up to 6 actuators with a power of 2W each. With more actuators in one zone, an additional relay should be used to make sure that actuators output will be not overloaded.

Example based on T30NC 230V actuators

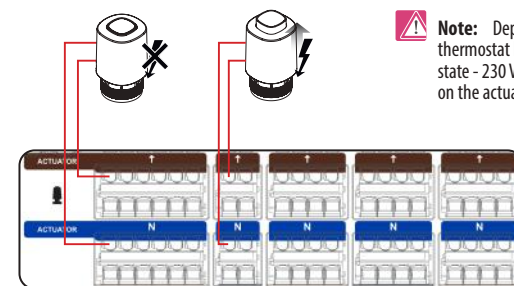

Note: Depends on the thermostat heating/cooling state - 230 V AC may appear on the actuators output.

5. Thermostats connection

• Connecting EXPERT NSB, HTR or BTR series thermostats

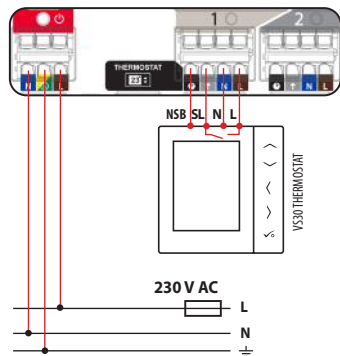

• Connecting a 230 V thermostat to the CB500X control box extension (e.g. SQ610)

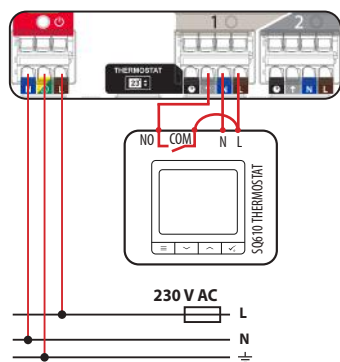

• Connecting ON/OFF battery-powered thermostat with voltage-free COM / NO output contacts (e.g. 091FL, RT310, RT510)

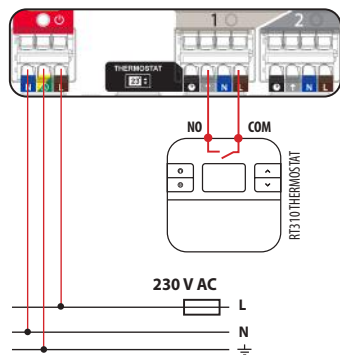

L	230 V live terminal
N	Neutral
Ⓛ	NSB function terminal
SL (↑)	230 V control signal

Note: In NSB, HTR, ERT, BTR product series follow interchangeable signifying:

- ↑ = SL
- Ⓛ = NSB

INSTALLATION



1 Remove the top cover of the extension module.

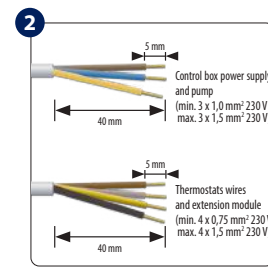

2 Remove the appropriate piece of insulation from the wires.

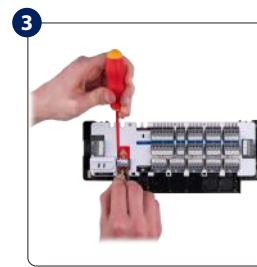

3 Connect the wires to the spring clamps according to the wiring diagrams. You can run the cables in the tunnel under control box housing.

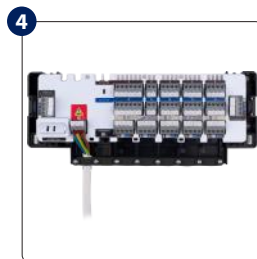

4 For safety use fastening strap to prevent power supply / thermostats wires from falling out.

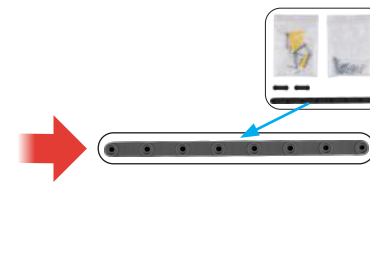

5 Make sure that all the wires are properly connected, mount top cover and power up the control box - the red power indicator LED will be illuminated.

6. Connection between CB500 and CB500X

If there is a need to increase the number of zones of CB500 control box, it is possible to connect the CB500 and CB500X units using the EXTENSION connector.

230V AC power is supplied only to the main CB500 control box. A maximum of two CB500X extension modules can be connected to the EXTENSION input of the main CB500 control box using a 4-wire cable (230V) - please pay attention to the terminal markings. All thermostats connected to the CB500 or CB500X have impact on the system module which controls the heat / cool sources in the main CB500 control box.

1

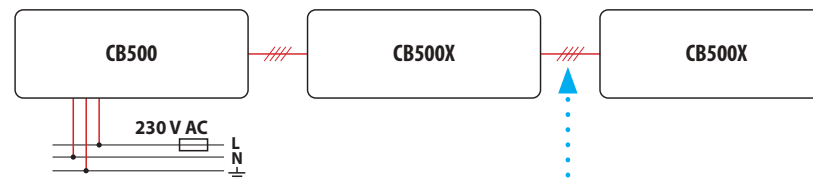

2

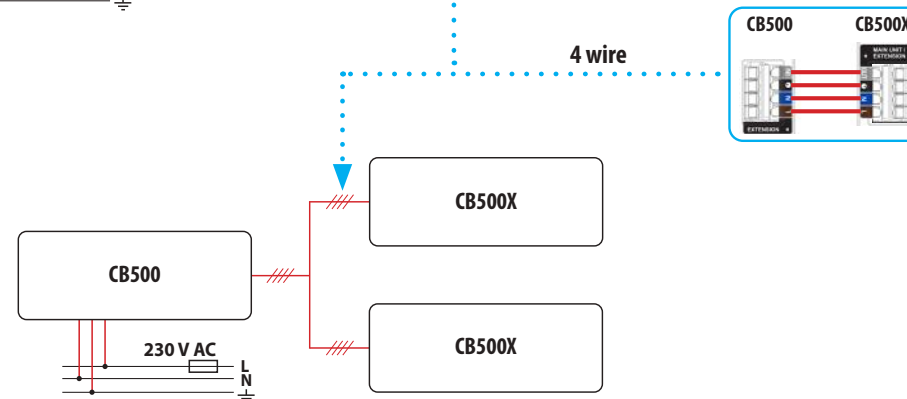

WARNING! DO NOT connect power supply to the CB500X power supply input when it is connected together with CB500. CB500X power supply input have to be used only when control box extension works as standalone device.