

Manual

SALUS Controls Plc
Units 8-10 Northfield Business Park
Forge Way, Parkgate
Rotherham, S60 1SD
United Kingdom



www.saluscontrols.com

SALUS Controls is a member of the Computime Group.

Maintaining a policy of continuous product development. SALUS Controls plc reserve the right to change specification, design and materials of products listed in this brochure without prior notice.

AUG 2021
V17



Control box description

1. Cartridge fuse 5 x 20 mm T10A
2. Power supply
3. NSB (Night Set Back reduction) function
4. Jumpers settings

5. Boiler control output (volt free)
6. Heat Pump / Chiller control output (volt free)
7. Heating / Cooling modes change input (volt free)
8. Dew point sensor input (volt free)

9. Pump/Valve control output (AC 230V)
10. Actuators output connections (AC 230V)
11. Thermostats input connections
12. CB500X extension input

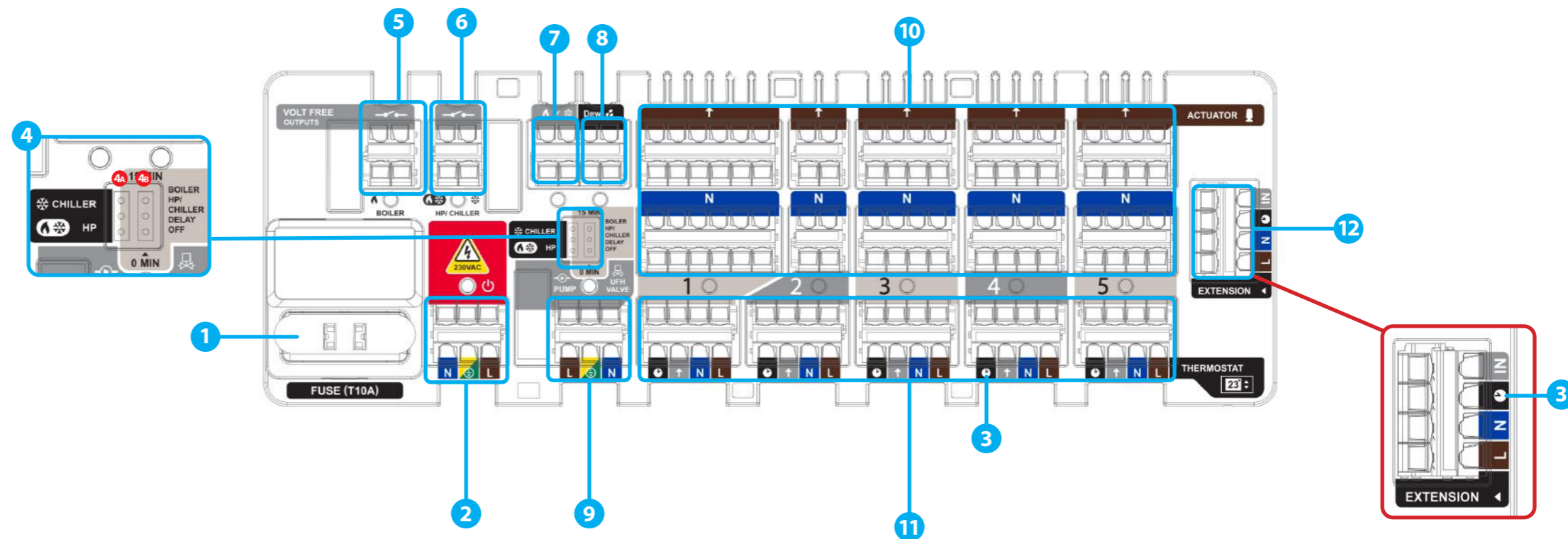

Introduction

The CB500 control box is the main element of the underfloor heating / cooling control system. It has a built-in module that controls the heat and cool sources. The control box allows you to control 5 different zones. Number of controlled zones can be increased up to 15 zones by using additional CB500X extension modules (CB500 main control box + two CB500X extension modules). Each individual zone can be operated by one thermostat. Thermostat which require 230V power supply has to be powered directly from control box. The CB500 has voltage-free outputs designed to control a boiler, heat pump or chiller. It allows you to switch between heating and cooling modes. It is equipped with 230V voltage outputs for a pump and actuators. The spring clamps provide quick and convenient wiring connections. The control box is designed to work with NC (normally-closed) type actuators. It is recommended to mount it on a surface or on a DIN rail.

Product compliance

This product complies with the essential requirements and other relevant provisions of the following EU Directives: EMC 2014/30/EU, Low Voltage Directive LVD 2014/35/EU, RoHS directive 2011/65/EU. The full text of the EU Declaration of Conformity is available at the following internet address: www.saluslegal.com.

Safety information

Use in accordance with current national and EU regulations. Device is intended for indoor use only in dry conditions. Product for indoor use only. Installation must be carried out by a qualified person in accordance to current national and EU regulations.

Before attempting to setup and install, make sure that CB500 is not connected to any power source. Installation must be carried out by a qualified person. Incorrect installation may cause damage to the control box. The CB500 should not be installed in areas where it may be exposed to water or damp conditions.

Technical Information

Power Supply	230 V AC 50 Hz
Total Load Max	7 (2) A
Pump / Boiler / HP (Chiller) Relay Load Max	5 (2) A
Inputs	Heating / Cooling modes change (volt free) Dew point sensor
Outputs	Boiler control output (volt free) Heat Pump / Chiller control output (volt free) Pump control (AC 230V) Actuators (AC 230V)
Dimensions [mm]	270 x 110 x 55

1. Fuse

Note: Replacement of the fuse to be carried out only when the control box is disconnected from power supply (230 V ~).

Main fuse is located under the housing cover next to power supply terminals and secures the control box and the devices connected to it. Use ceramic tube slow blow 250 V ROHS fuses (5x20 mm) with nominal max current 10A. To replace fuse remove the fuse holder with a flat screwdriver and pull out the fuse.

2. Power Supply

Power supply for control box is 230 V ~ 50Hz.

Three wire installation should be made in accordance with the current applicable regulations.

The red LED will illuminate indicating that the control box is connected to the power supply.

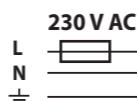
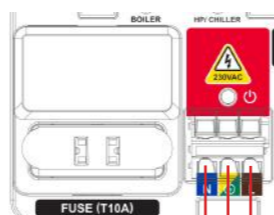

3. NSB (Night Set Back reduction) function

The NSB (Night Set Back) function enables you to automatically reduce the setpoint temperature on non-programmable thermostats via programmable thermostat connected to the same control box or an extension module. NSB function changes comfort to economic setpoint temperatures for each thermostat individually. The programmable thermostat, e.g. installed in the living room, sends a signal to the non-programmable thermostats through a control box (by wires). Then, the non-programmable thermostats automatically reduce the setpoint temperature according to the value set on them. The NSB terminal is marked with the clock icon - all NSB terminals are connected together within control box. The NSB function works only in a 4-wire installations (see connection diagrams).

4. a) Heat Pump / Chiller logic selection (HP/CHILLER output)

When connecting the HP / CHILLER output to an external heat / cooling source, pay attention to the setting of the jumper responsible for the HP/CHILLER output.

When the jumper is set to "HP" position (default setting) then HP/CHILLER output (volt free relay) is activated/deactivated each time thermostat starts (stop) heating or cooling. When the jumper is set to "CHILLER" position then HP/CHILLER output (volt free relay) is activated/deactivated only when CB500 is in cooling mode (please refer to chapter 7) and thermostat starts (stop) cooling.

The factory setting of the jumper is HP

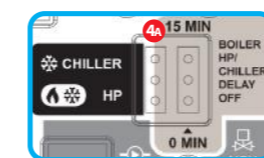

4. b) Turn OFF delay of the Heat/Cool source (BOILER and HP/CHILLER outputs)

This jumper sets the turn off delay time of the BOILER and HP / CHILLER control outputs.

When the jumper is set to "0 MIN" position (default setting) then BOILER and HP/CHILLER output (volt free relays) are deactivated immediately when thermostats stop heating or cooling.

When the jumper is set to "15 MIN" position then BOILER and HP/CHILLER outputs (volt free relays) are deactivated 15 minutes after thermostats stop heating or cooling.

PLEASE NOTE:

When the jumper is set to 15 minutes delay time you must ensure hydraulic flow in the system when all actuators are closed. Use a bypass or differential pressure valve.



5. BOILER control output

Boiler ON/OFF contacts (according to the boiler's manual)

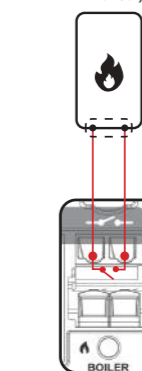

Boiler output - this is a volt free output (COM / NO) which controls heating system boiler. If any of thermostats connected to the control box sends signal for heating, BOILER output is activated after 3 minutes delay, giving permission for boiler to turn ON. If all thermostats connected to the control box stop sending signal for heating, then BOILER output is deactivated - this is the signal for boiler to turn OFF (BOILER output can work with 0min or 15min delay - please refer to chapter 4b).

When the boiler output is activated, the LED shows a constant green light.

6. Heat Pump / Chiller control output

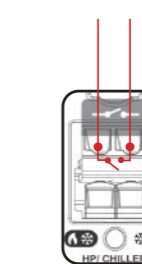

HP/CHILLER volt free output (COM / NO) is specially designed to work with the source of heating and cooling (Heat Pumps) or only cooling (Chillers). If any of thermostats connected to the control box sends signal for heating or cooling, HP/CHILLER output is activated after 3 minutes delay, giving permission for connected heat pump or chiller to turn ON. If all thermostats connected to the control box stop sending signal for heating or cooling, HP/CHILLER output is deactivated, giving permission for connected heat pump or chiller to turn OFF (HP/CHILLER output can work with 0min or 15min delay - please refer to chapter 4b). It can operate in heating and cooling modes or only in cooling mode (please refer to chapter 4a).

When the Heat Pump / Chiller control output is deactivated, the LED shows a constant green light.

7. Heating/Cooling modes change input



When Heating/Cooling input is opened - that means CB500 works in the heating mode.

When Heating/Cooling input has a link installed (bridged) - that means CB500 works in cooling mode.

NOTE: In cooling mode BOILER output is disabled. HP/CHILLER output is enabled/disabled dependently on the HP/CHILLER jumper setting (please refer to chapter 4a).

Symbol	Diode	Mode
	Red	Heating
	Blue	Cooling

8. Dew point sensor input



If the installation is equipped with a dew point sensor, it should be connected into the DEW POINT input. When condensation is detected (DEW POINT contacts shorted), PUMP and HP/CHILLER outputs are switched off immediately to prevent floor damage. DEW POINT input is only active in cooling mode.

When the Dew point sensor input contact is closed, the LED shows a constant red light.

9. Pump/Valve control output

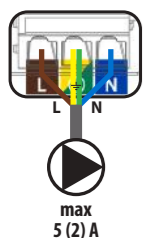

PUMP/VALVE output - this is a 230 V AC output that controls the pump and valve of the heating and cooling systems. If any of thermostats connected to the CB500 send heating / cooling signal - PUMP/VALVE output will be activated after 3 minutes. If all of the thermostats connected to the CB500 stop sending heating / cooling signal - PUMP/VALVE output will be deactivated after 3 minutes.

When the Pump/Valve control output is activated, the LED shows a constant green light.

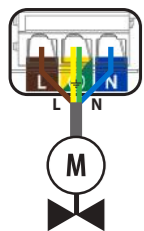

Warning:
Before starting the installation, disconnect the 230V power supply!

10. Actuators connection

Actuators wires should be plugged into the spring clamps of the respective zones. Maximum current load for each zone is designed to handle up to 6 actuators with a power of 2W each. With more actuators in one zone, an additional relay should be used to make sure that actuators output will be not overloaded.

Example based on T30NC 230 V actuators

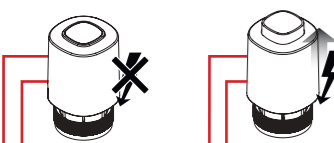

Note: Depends on the thermostat heating/cooling state - 230 V AC may appear on the actuators output.

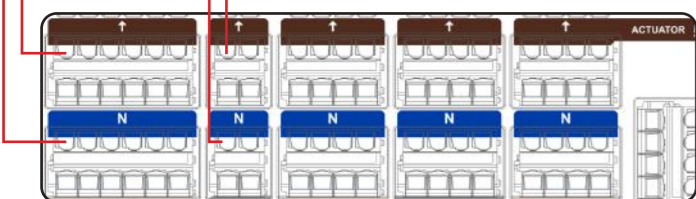

11. Thermostats connection

• Connecting EXPERT NSB, HTR or BTR series thermostats

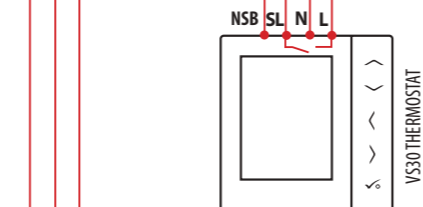
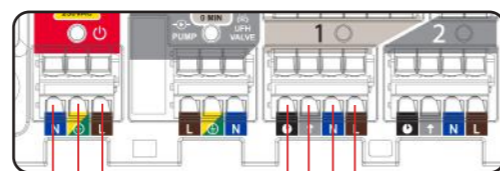

• Connecting a 230 V thermostat to the CB500 control box (e.g. SQ610)

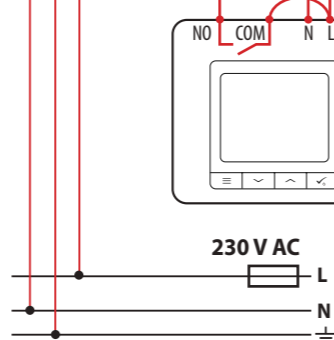
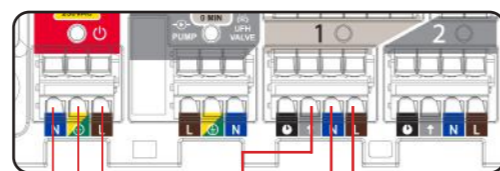

• Connecting ON/OFF battery-powered thermostat with voltage-free COM / NO output contacts (e.g. 091FL, RT310, RT510)

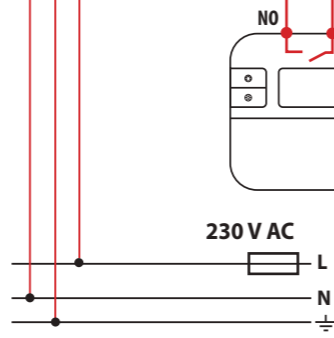
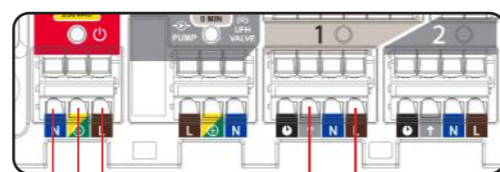

L	230 V live terminal
N	Neutral
	NSB function terminal
SL (↑)	230 V control signal

Note: In NSB, HTR, ERT, BTR product series follow interchangeable terminals description:
↑ = SL
⌚ = NSB

INSTALLATION



Remove the top cover of the control box.

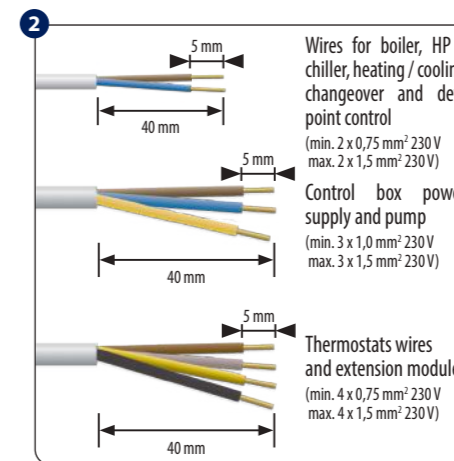

Remove the appropriate piece of insulation from the wires.

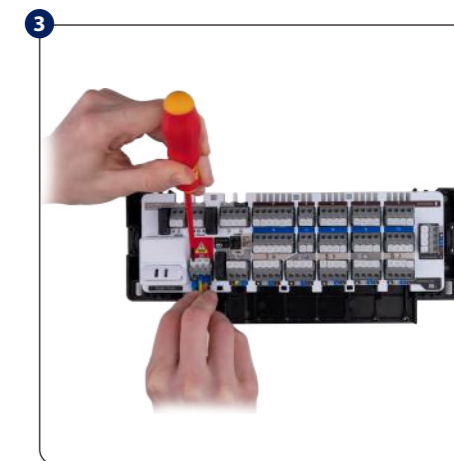

Connect the wires to the spring clamps according to the wiring diagrams. You can run the wires in the tunnel under control box housing.

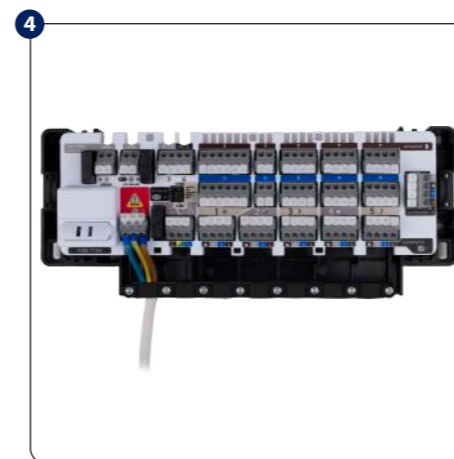

For safety use fastening strap to prevent power supply / thermostats wires from falling out.

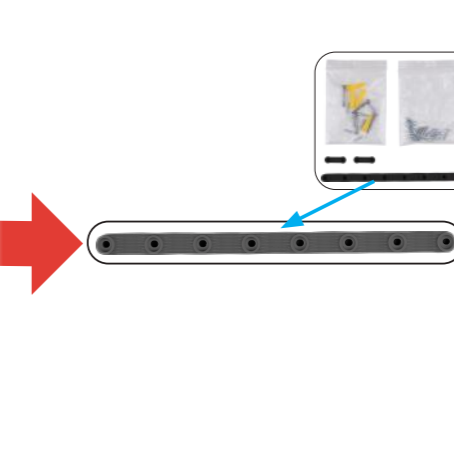

Make sure that all the wires are properly connected, mount top cover and power up the control box - the red power indicator LED will be illuminated.

12. Connection between CB500 and CB500X

If there is a need to increase the number of zones of CB500 control box, it is possible to connect the CB500 and CB500X units using the EXTENSION connector.

230V AC power is supplied only to the main CB500 control box. A maximum of two CB500X extension modules can be connected to the EXTENSION input of the main CB500 control box using a 4-wire cable (230V) - please pay attention to the terminal markings. All thermostats connected to the CB500 or CB500X have impact on the system module which controls the heat / cool sources in the main CB500 control box.

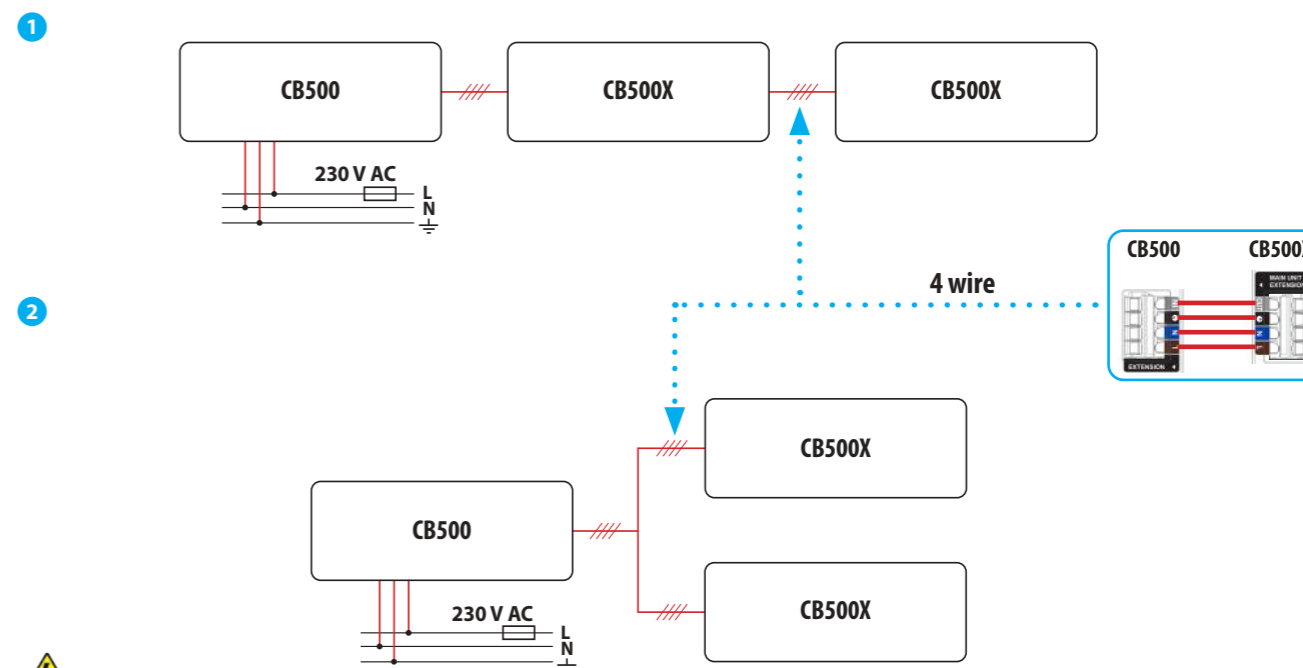

WARNING! DO NOT connect power supply to the CB500X power supply input when it is connected together with CB500. CB500X power supply input have to be used only when control box extension works as standalone device.