

SALUS
CONTROLS

ENERGY SOLUTIONS

EV CHARGER



Installation Manual



MULTILANGUAGE
MANUAL



Contents

Smart Charging with SALUS.....	3
SALUS EV Charger (AC).....	4
Important Safety Information.....	5
Electrical Protection	7
Overview.....	8
LED Status	9
Technical Specifications.....	10
Installation and electrical connections.....	11
Setup.....	17
Step 1: Download the SALUS App	17
Step 2: (If needed) Create Smart EV Charger account	17
Step 3: Adding your first EV Charger.....	19
Step 4: Managing multiple chargers.....	22
Dashboard features and settings.....	23
Step 5: Charging flow	24
Charging flow - potential displays.....	25
In-App Settings for the EV Charger.....	26
Other App Settings.....	30
Changing the EV Charger Wi-Fi network or Performing Factory Reset.....	32
CT Clamp & Load Curtailment feature.....	34
Disposal of the SALUS EV Charger.....	40
Troubleshooting and Error Codes.....	41

Smart Charging with SALUS

The SALUS EV Charger is a smart charging solution designed for efficiency, security, and ease of use. It features a Type 2 charging connector, ensuring compatibility with a wide range of electric vehicles.

For user authentication, the charger supports NFC card access, allowing simple tap-to-charge functionality. Additionally, it connects to the SALUS mobile app via Wi-Fi and cloud integration. Through the app, users can monitor charging status, schedule sessions, and track energy consumption remotely.

With its combination of smart connectivity, cloud-based controls, and multiple access options, the SALUS EV Charger ecosystem offers a seamless and user-friendly charging experience.

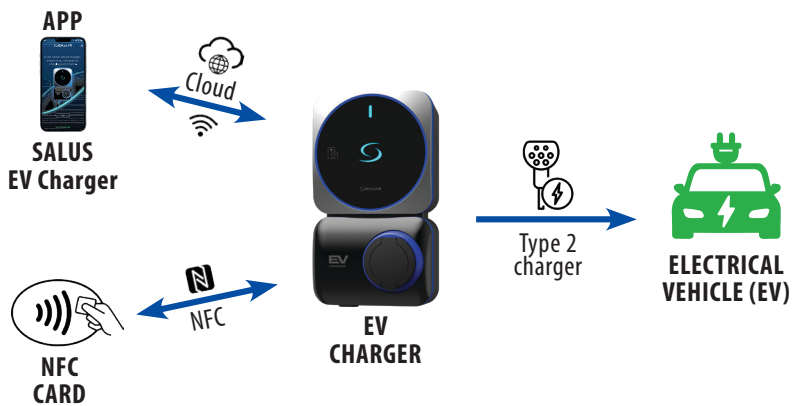

SALUS EV Charger (AC)

MODEL NUMBER

EV7EU : 7kW (1-phase) socket type

EV11EU : 11kW (3-phase) socket type

EV7UK : 7kW (1-phase) socket type (UK version)

The Salus EV Charger Mode-3 AC series offers charging power from 7kW to 11kW via a Type-2 socket for your Electric Vehicles. Its slim design makes it suitable for both indoor and outdoor environments, ideal for residential use.

It connects to the Internet via Wi-Fi and can be controlled using a smartphone app. The app provides:

- Charging monitoring and control
- Off-peak scheduling for cost-efficient charging
- Charging history for tracking and analysis
- NFC access management for authorized users
- Multi-charger management in one account

The UK model (EV7UK) includes PEN fault detection, eliminating the need for an additional earth electrode, and complies with UK EV (Smart Charge Points) Regulations.

Important Safety Information

 The installation, maintenance, & servicing **must be carried out only by suitably qualified personnel in accordance with all applicable local regulations.** The installer is responsible for ensuring that the work complies with relevant local, regional and national standards and guidelines.

 When using electric products, basic precautions should always be followed.

 **Correctly isolate the supply** before installing or cleaning the EV charger.

 **Install the EV charger well away from flammable or explosive materials, chemicals or solvents, gas pipes or steam outlets, radiators or batteries, and any areas prone to flooding, high humidity or running water.** Never spray liquid into the charging socket or connector, submerge the connector in liquid, or open the cover in the rain.

 **Use the EV Charger only within the specified operating temperatures.**

 **Do not use if the EV Charger is damaged, isolate from supply and contact a qualified engineer.**

 Do not attempt to disassemble, repair, tamper with or modify the EV charger. Do not insert fingers or any objects into the charger or its terminals.



Do not use cleaning solvents on any part of the charger. Use a clean, dry cloth to remove dust and dirt.



Always keep children under close adult supervision when they're near the EV charger to prevent accidental tampering, misuse or electric shock.



Upon unpacking, ensure the charger has been stored within its specified temperature range. Handle the unit gently to avoid impacts or drops that could damage any components, and inspect it for signs of damage before installation.



Ensure that every safety and installation guideline has been followed when fitting and using the EV charger. If the charger is installed or tested incorrectly, it may damage your vehicle's battery or components, harm the charger itself, and create a safety risk..



The information in this manual may be changed without prior notice. It does not represent any obligation on the part of the manufacturer. Images in this manual are for illustration purposes only and might differ from the delivered product.

Electrical Protection

- The EV Charger must be permanently connected to the electrical Earth of the installation.
- Certified Circuit Breakers should be installed upstream and shall comply with standard IEC 60898-1. The rated voltage and current of the Circuit Breakers shall be 230V single phase / 400V three phase with a maximum current rating of 40A for the 7kW model and a maximum current rating of 20A for the 11kW model.
- Install an upstream RCD conforming to IEC 61008-1 or IEC 61009-1, with a 30 mA tripping current and the appropriate leakage-detection characteristic (Type A or Type B) as required by local regulations. Select an RCD rated for the charger's supply: 230 V AC, 40 A for the 7 kW model; 400 V AC, 20 A for the 11 kW model.
- Ensure the EV charger supply includes both overcurrent protection and residual-current protection. Fit a suitably rated MCB together with an RCD (30 mA trip) upstream of the charger, in accordance with local wiring regulations.
- The combination of the EV Charger and the RCD (i.e. RCCB, RCBO, etc.) installed upstream can meet the requirements of OVCIII.
- The installer must select the RCD, Circuit Breaker, earthing configuration (ground earth connection is required) and any devices by following the current local regulations. Local installation guideline should also be followed to ensure the unit is installed in accordance to any local restrictions. All these protection devices shall be chosen with appropriated technical specification, such as:

Working voltage \geq charging station working voltage,
Working current \geq charging station working current,
Ingress Protection (IP) \geq IP54 or installed inside IP54 protection box
for outdoor use.

Overview

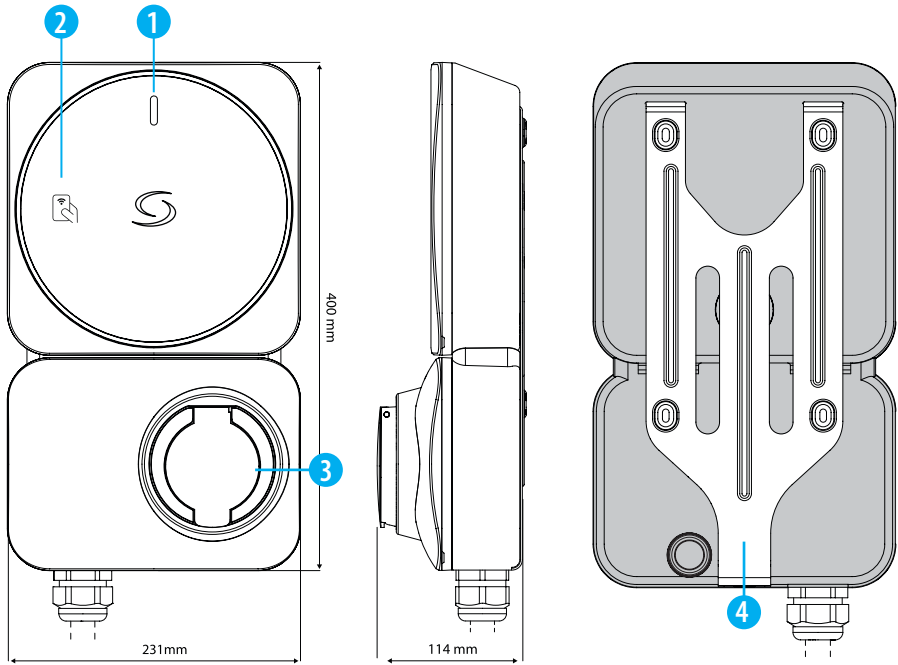

- 1. LED status indicator
- 2. NFC reader for authentication















- 3. Type 2 charging socket
- 4. Y-shape metallic wall mount

MODEL	NO. OF PHASES	OUTPUT CURRENT	CONNECTION	POWER
EV7EU	1- PHASE	32A	TYPE 2 SOCKET	7kW
EV11EU	3 - PHASE	16A	TYPE 2 SOCKET	11kW

For UK only (with PEN fault protection)

EV7UK	1 - PHASE	32A	TYPE 2 SOCKET	7kW
--------------	-----------	-----	---------------	-----

LED Status

DURING SETUP		
Ready to set up Wi-Fi		SLOW Blink
Connected to Wi-Fi		SLOW Blink
Connected to Cloud (or OCPP server)		Solid
No connection		FAST Blink
CHARGING OPERATION		
Standby		Solid
Charger is locked		SLOW Blink
Charger is waiting for NFC		Solid
Charger is waiting for schedule		SLOW Blink
Charger is waiting for EV to start charging		SLOW Blink
Charging		Solid
Finished charging		Solid
NFC card is verified		Blink 3 times
NFC card verification failed		Blink 3 times
Error (disconnect all cable, switch off main power supply and contact technician)		Solid

Technical specifications

	SINGLE PHASE (EV7EU / EV7UK)	THREE PHASE (EV11EU)
Input voltage	230V AC 50Hz	400V AC 50Hz
Charging current & power	32A / 7kW	16A / 11kW
Cable section	6 mm ² to 10 mm ²	2.5 mm ² to 10 mm ²
Charging mode	Mode 3	
Charging connector	IEC 62196 - Type 2 socket with lock	
Cable entry	Bottom and rear side	
Electrical protection	6mA DC residual current detection Anti-welding protection Over current protection Over/under voltage protection Over temperature protection Surge protection PEN fault protection (EV7UK only), without the need for additional earth rod installation.	
LED display	LED backlight for logo and multi-colour LED for charging status	
NFC reader	Mifare (13.56MHz), ISO14443-A	
Connectivity	IEEE 802.11bgn Wi-Fi (2.4GHz)	
Communication	Mobile App operation	
Firmware update	Over the air firmware update capability	
Security	Wi-Fi : WEP, WPA-TKIP, WPA2-CCMP, PMF and WPA3	
Ingress protection rating	IP54	
Impact protection rating	IK08	
Material (Enclosure)	PC UV stabilized (UL94 V-0 fire rated)	
Storage temperature	-30°C to 80°C	
Operating temperature	7kW model : -25°C to 50°C	11kW model : -25°C to 45°C
Operating humidity	Up to 95% RH (non-condensed)	
Working altitude	Up to 2,000m	
Dimensions (H x W x D)	400mm x 231mm x 114mm	
Net weight	3.7kg	
Accessories	Y-shape mount NFC card x 3 pcs	

Installation & electrical connections

1. Mount the EV charger

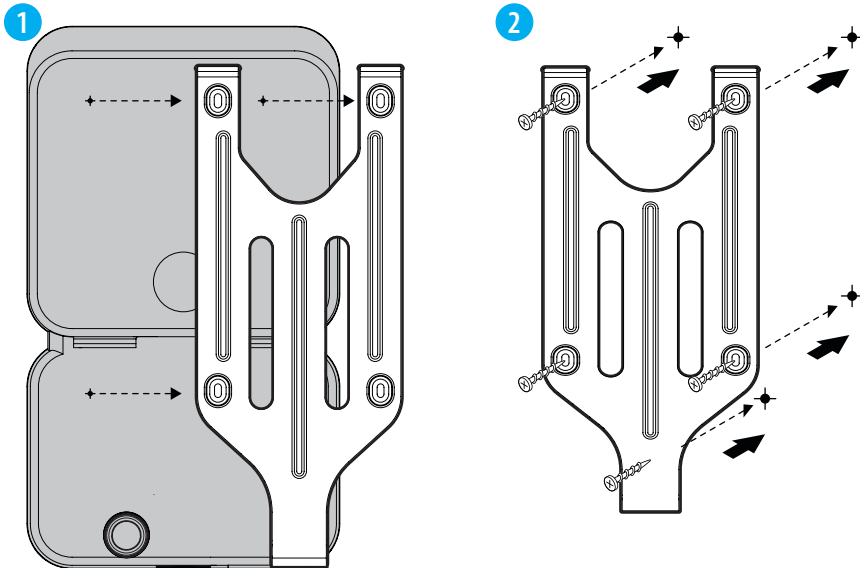

Use the screws (included) to fix the mounting plate on to the wall.

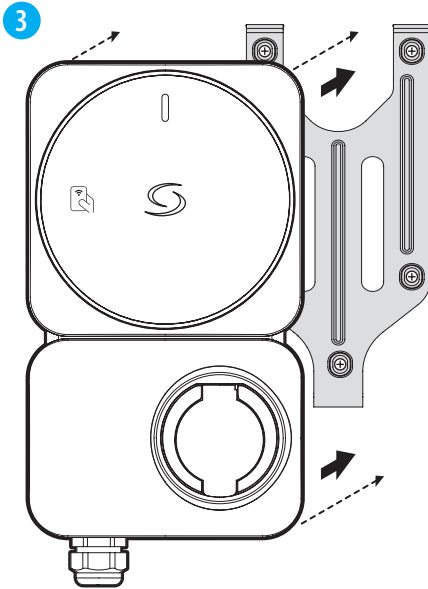

Attach the EV charger back to the mounting plate.

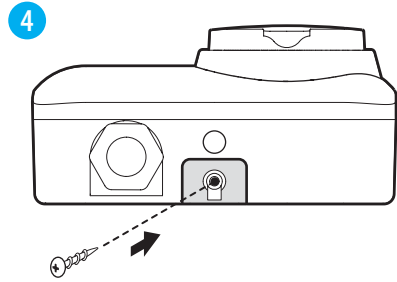

Tighten the screw at the mounting plate bottom to fix the EV charger firmly to it.

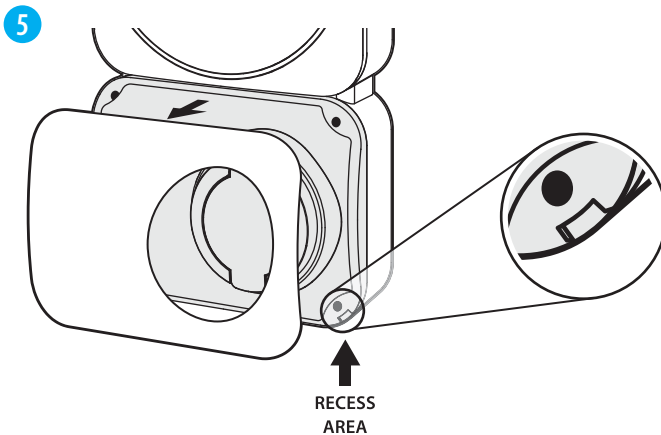

Open the decorative cover, there is a **recess area** at the corner for opening it easily.

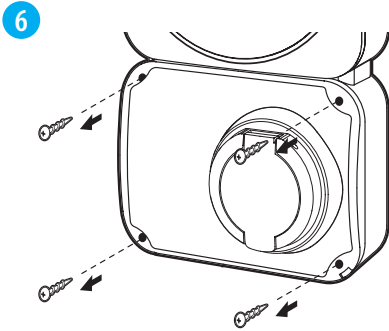

Loosen the screws at each corner of the inner cover, then open it to access the internal part for wiring and set up.

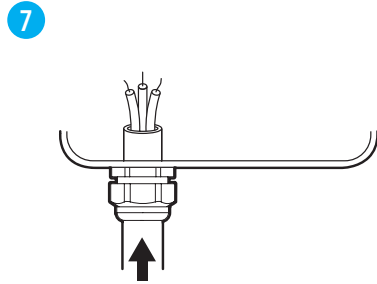

Pass the power supply cable through the cable gland supplied.

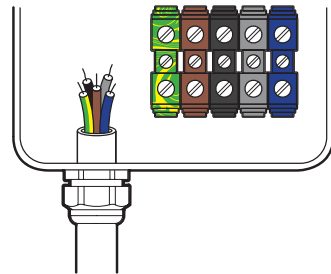
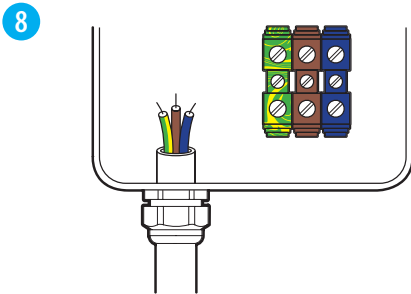

Insert the cable into the EV charger and connect it to the terminals, following the configurations listed for **single-phase** or **three-phase** power input.

EV7EU / EV7UK

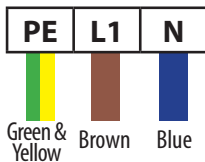

EV11EU

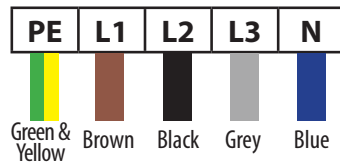

Tighten the terminal screws up to 1.2 Nm. Do not over-tighten.

Strip 12–14 mm of insulation from the wire to expose the metal conductor, ensuring proper electrical contact.

* The above colors are used following the IEC standard, some regions may use other standardised colours.

9

Maximum charging current: can be adjusted by turning the shown Rotary Switch to the position corresponding to the desired limit (see table).

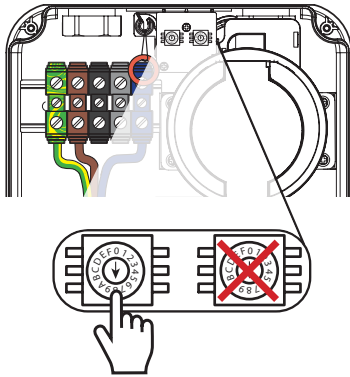

POSITION	CURRENT LIMIT
1	6A
2	8A
3	10A
4	13A
5	16A
6 (For 7kW versions only)	20A
7 (For 7kW versions only)	24A
8 (For 7kW versions only)	32A



Using positions not listed in the provided table may cause an error.



ONLY USE THE LEFT ROTARY SWITCH to adjust the maximum current output according to table.



DO NOT use or adjust the right rotary switch.



The new setting will take effect after a power reset.

10

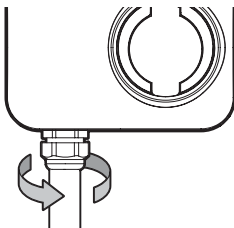

After finishing the wiring, the **cable gland** must be tightened to the EV charger in order to secure the cables.

11

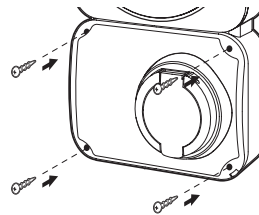

Install the exterior cover and tighten the screws securely.

For Rear Entry Installation:

1

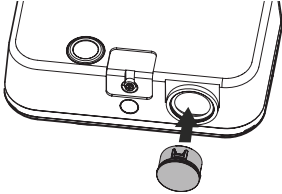

Seal the bottom cable entry hole with the provided cover to protect the unit.

2

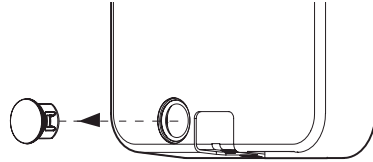

Remove the rear entry cover.

3

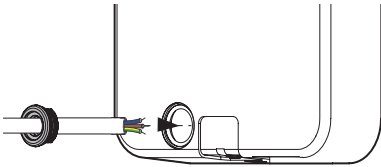

Pass the cable through the provided rubber grommet.

4

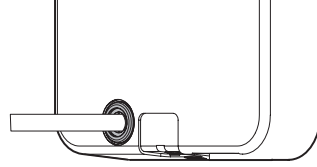

Secure the cable into rear entry hole.

5



Connect the cable wires to terminals.



Please note: Rear entry installation does not require cable glands.

2. Finish the installation

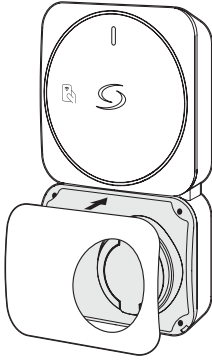

Position the decorative cover over the top cover, aligning it properly.

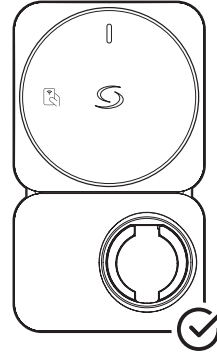

Installation is complete.

Power outage manual release: The socket version has a locking mechanism that secures the charging cable to prevent unauthorized disconnection. If a power outage occurs during charging, the cable remains locked and automatically releases when power is restored. To manually unlock it before power returns, pull the red ring attached to the locking mechanism, unplug the cable, and reinstall the covers securely.



Before opening the EV charger cover, ensure the power is switched off at the circuit breaker.

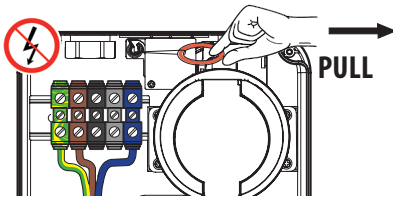

Pull the red ring

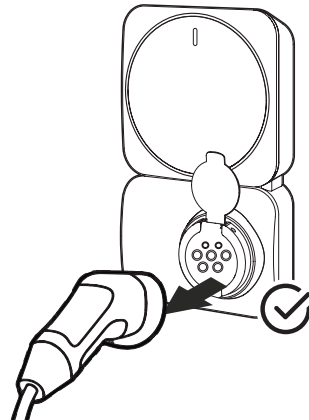

Setup

Step 1: Download the SALUS App



Download the Salus EV charger App and register an user account.



*If you already have a **SALUS Premium Lite** account, it can be used for the EV Charger app as well.*



Please note that the app images shown are for reference only and may be updated regularly. Please refer to the actual app for the latest version.

Step 2: (If needed) Create Smart EV Charger account

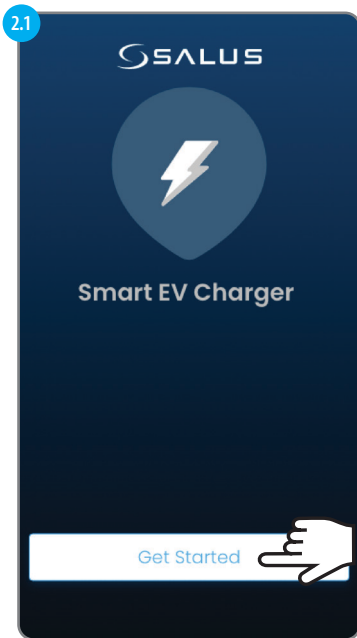

In order to create an account, select the **SIGN UP** option.

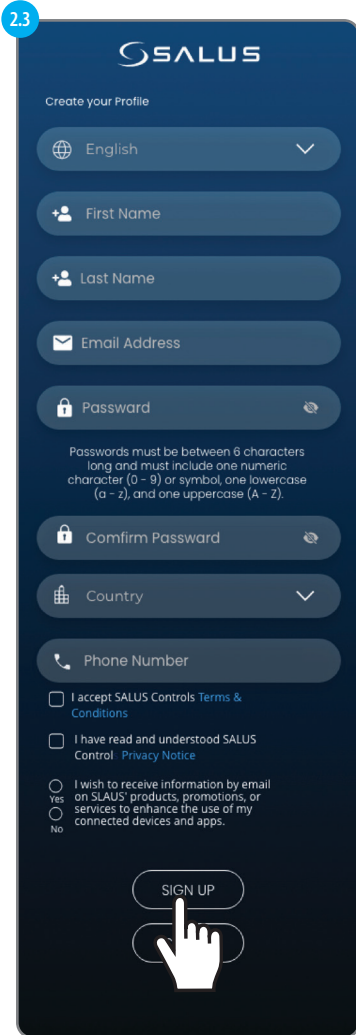

Add the info requested in order to proceed with account creation.
Then select **SIGN UP**.

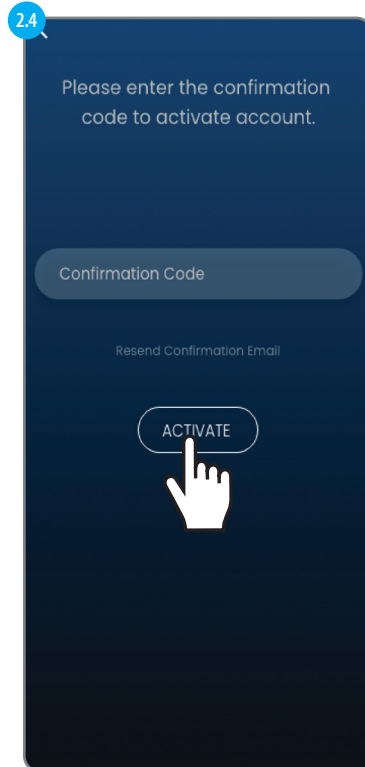

A confirmation code email will be sent via email. Add the code and then select **ACTIVATE**.

Step 3: Adding your first EV Charger

For the first time set up, the EV charger will broadcast a Wi-Fi Access Point continuously for your mobile device to connect to it for set up.

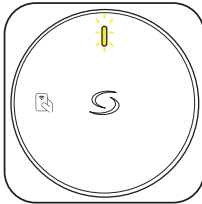

During the initial setup, the LED flashes yellow.

Once the EV charger is set up connecting to any Wi-Fi network, the Access Point will be turned OFF in 20 minutes after the mobile device is disconnected. If the Wi-Fi needs to be set up again, power reset the EV charger and the EV charger will broadcast the Access Point again.



Select **ADD** in order to proceed with the addition of the EV Charger to the app.

3.2

Please follow the on-screen instruction to set up the EV charger Wi-Fi connection to the Internet and adding the EV charger to the user account.

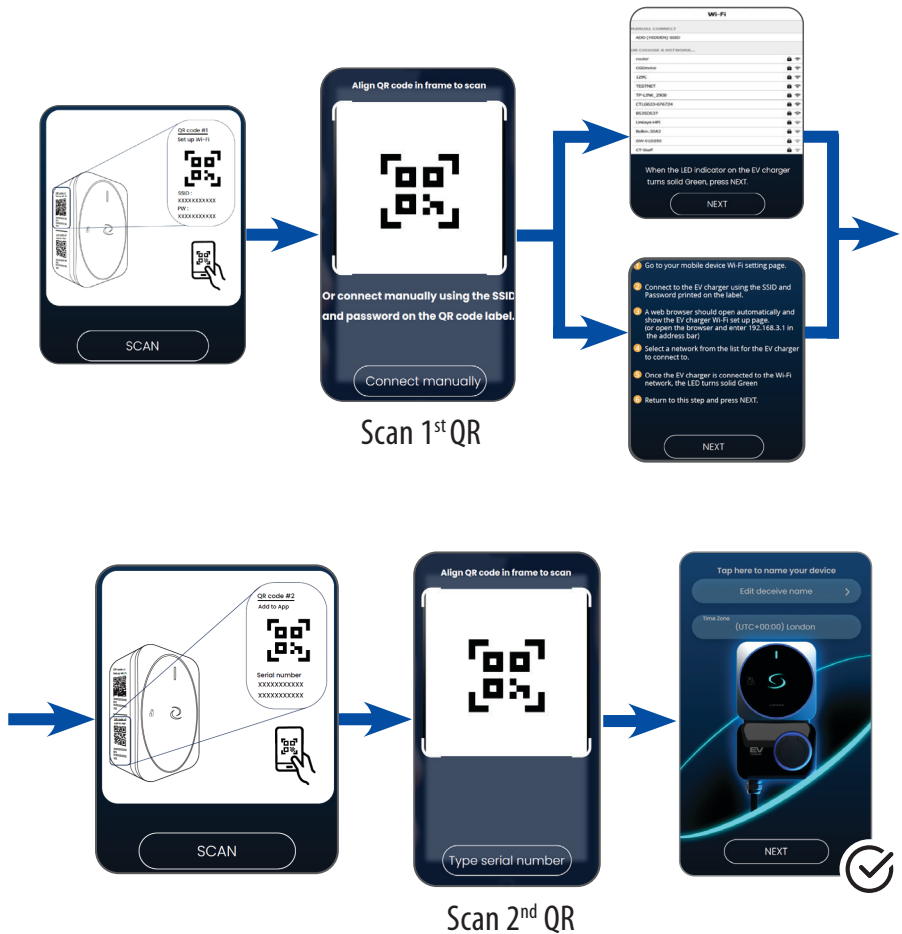



Add a name for the device & set Time Zone

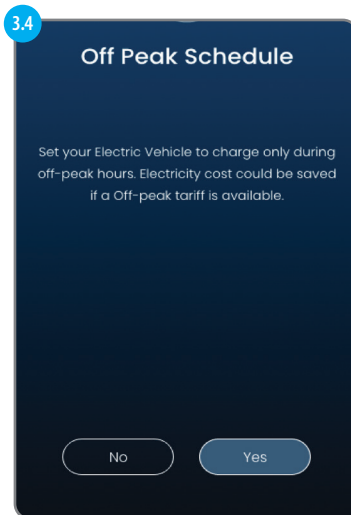

Set your choice for Off Peak Schedule

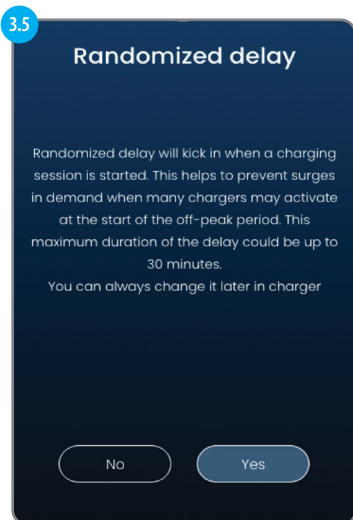

Set your choice for Randomized delay

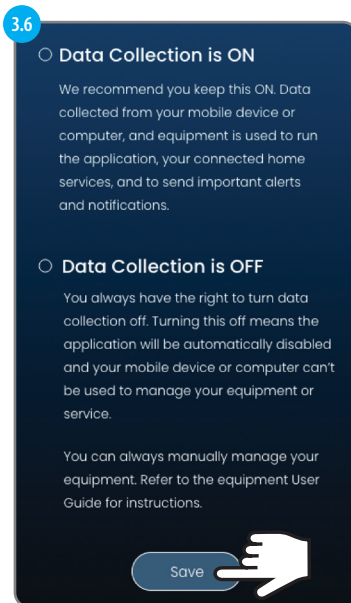

Set your choice for Data Collection and select **Save**

Step 4: Check the firmware version before the first charge

Make sure the EV charger is running the latest firmware. If an update is available, install it. For the procedure, see “App Settings – EV Charger”, step c.1 (page 27)

Step 5: Managing multiple chargers

Multiple chargers can be associated with a single user account. This allows the user to conveniently monitor and manage all of their chargers from one place.



Swipe the app's dashboard to cycle through different chargers

Dashboard features and settings



Step 5: Charging flow



Connect the charging cable to the EV and the EV charger.
Swipe NFC card on the EV charger, or select **Start** to start charging.



Wait to reach charging schedule, or select Boost to override schedule and charge at once.



Charging is initiated.



Charging starts.

Charging flow - potential displays



Charging screen.



This screen will appear when EV chargers stops or suspends receiving charge.

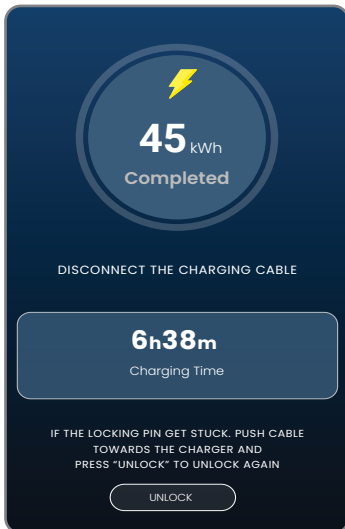

Charging completed.

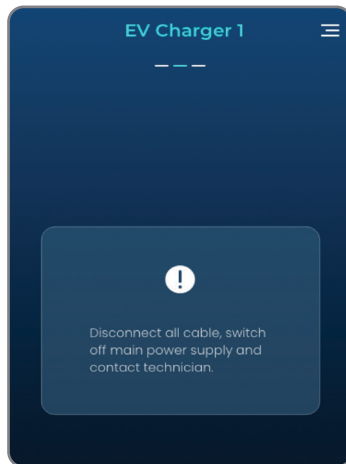

Error screen.

In-App Settings for the EV Charger

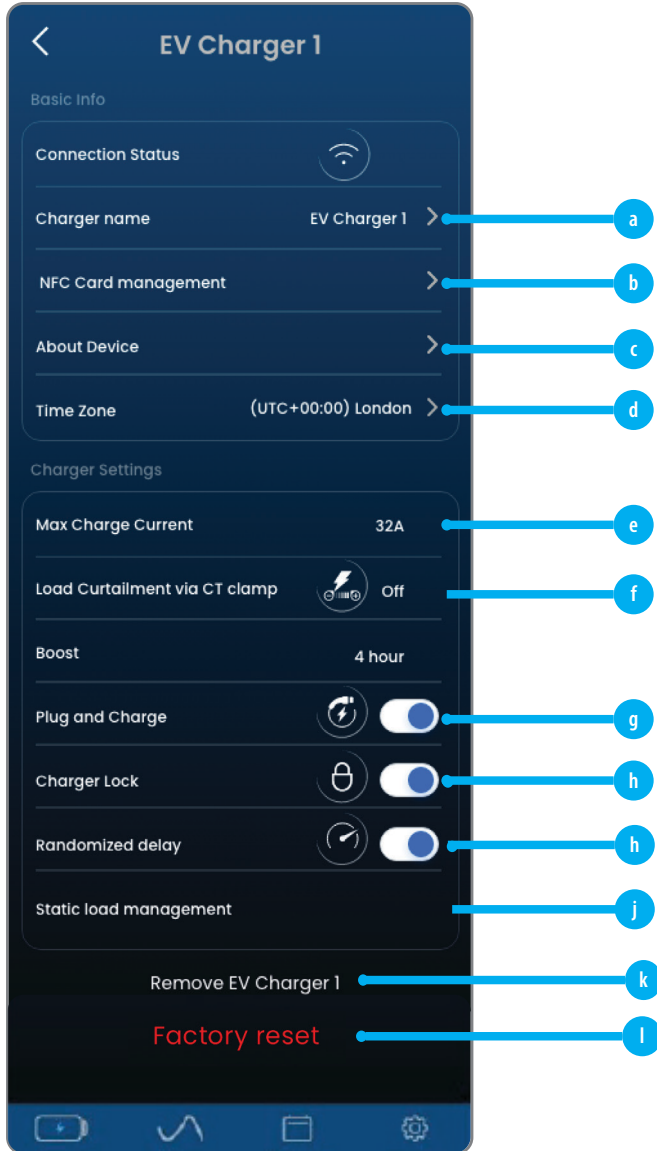

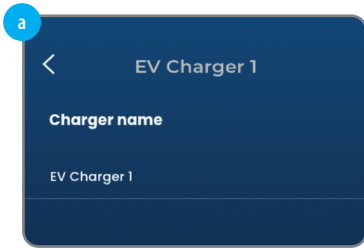

Here the name of the EV charger can be changed.

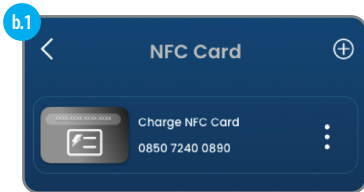

When Plug&Charge is disabled, authorization is required before charging, either by using the App or by swiping NFC card on the EV charger. To manage which NFC card can initiate charging, this screen allows adding new NFC card (by scan QR code or input card number) to the EV charger, and can edit/remove afterwards.

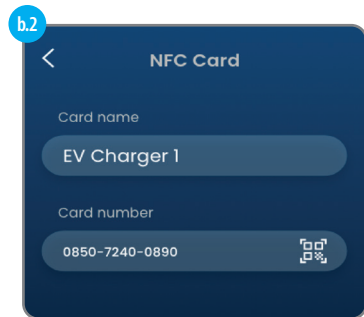

**Each EV charger has its own NFC card list, same card can be added to different EV chargers.*



This screen displays information about the EV charger, including the current firmware version. If a newer firmware version is available, a red download icon will appear. Press the icon to update manually. **Note:** If you do not update manually, the firmware will update automatically within 24 hours of a new release.

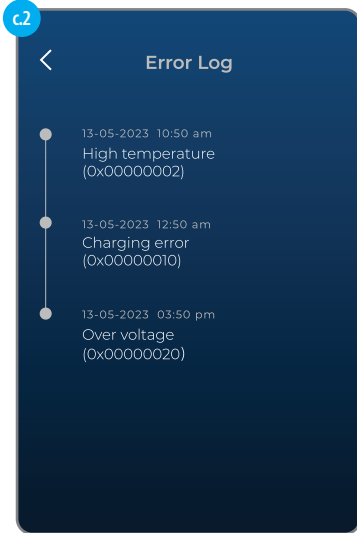

An error Log is also available for checking if the EV charger cover has encountered any errors while operating.

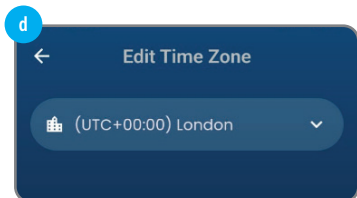

Edit Time Zone.

Other Charger Settings

Max Charge current

- e It shows the maximum charging current the EV charger can provide. (It is affected by both the model and the hardware setting inside the EV charger).

Load Curtailment via CT clamp

- f Automatically limits EV charging using CT clamp readings to keep within your mains supply limit and prevent trips.

Plug and Charge

- g When enabled, the EV charger can initiate charging without authorization from App or NFC card.
Charging starts right away or after a while depends on if any schedule or randomized delay is applied.

Charger Lock

- h When locked, the EV charger will not provide charging.

Randomized delay

- i When enabled, this feature applies a randomised delay of a maximum of 30 minutes before each charging session begins. This helps protect the supply infrastructure by preventing multiple sessions from starting simultaneously.

Static load management

- j This setting can limit the EV charger's output when needed.

Remove

- k Removes the EV charger from the user account.

Factory reset

- l Factory reset will clear all settings, including the Wi-Fi connection to the home router. This reset will also remove the EV charger from the current user account.

Other App Settings

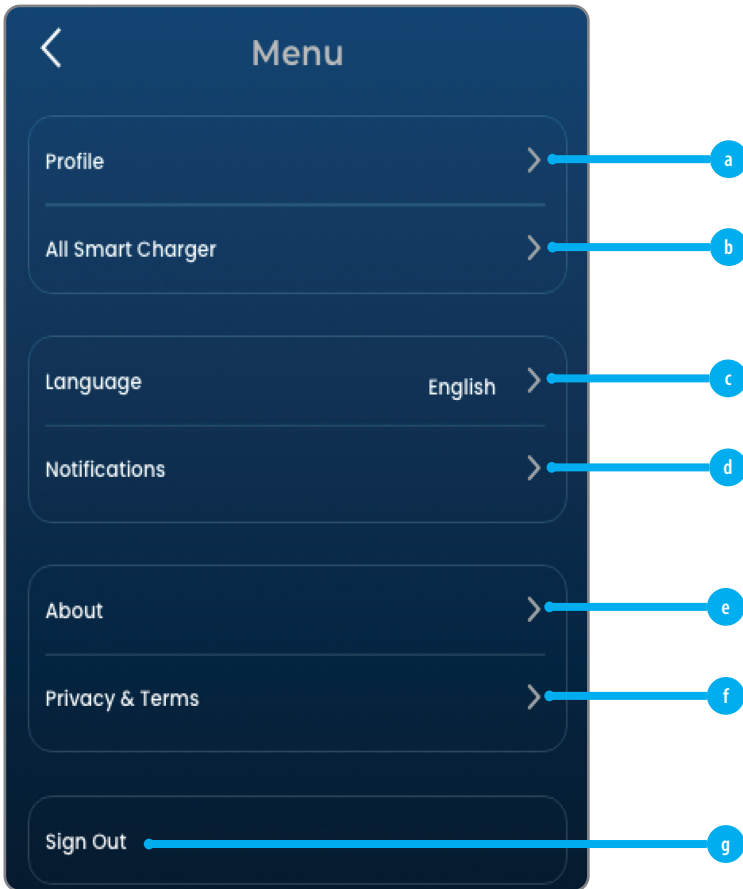

Other App Settings

- a Profile**
User information.

- b All Smart Charger**
Displays all EV chargers added to this user account, and their current status.

- c Language**
Change App display language.

- d Notification**
Enable/Disable App notification when EV charging starts or ends.

- e About**
App information.

- f Privacy & Terms**
Diverts to Privacy & Terms document.

- g Sign out**
Signs out the current user from the App.

Changing the EV charger Wi-Fi network or Performing Factory Reset

Use a mobile device to connect to the EV charger access point.



1

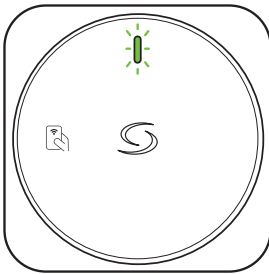

Power reset the EV charger to turn on the Access Point. It will be open for 20 minutes for a mobile device to connect to.

2

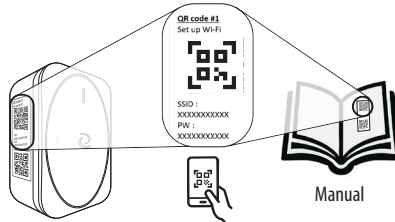

Scan the QR code #1 printed on the charger label and at the end of the Instruction Manual to connect automatically.

Or

Connect manually from the Wi-Fi list of the phone by searching the network name (SSID) and adding the password (PW) printed on the label.

3

Once connected, the web browser on the mobile device should open automatically and show the EV Charger Wi-Fi set up page.

Otherwise, **scan the QR code** in order to access the Wi-Fi set up page.

or

Open the browser and enter **192.168.3.1** in the address bar.



In the Wi-Fi setup page you can:

- a Modify the EV charger setting to connect to other Wi-Fi network to the Internet

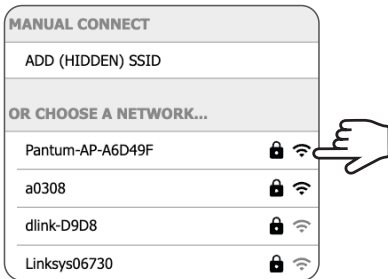

On the Wi-Fi set up page, select the new network from the list and enter the password to connect the EV charger to it.

- b Perform a factory reset if the EV charger cannot be factory reset via the app (even without an Internet connection).

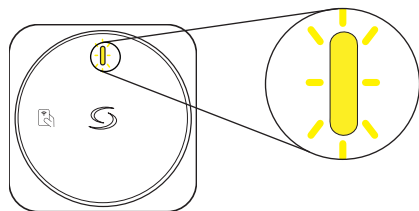
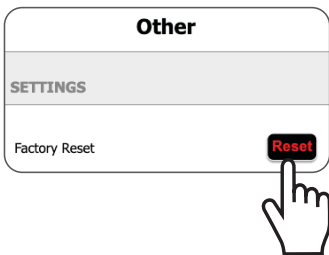





Once the factory reset is finished, the LED on the charger flashes Yellow.

CT Clamp & Load Curtailment feature

 (Accessories purchased separately)

Electric vehicle charging can place high demand on a household's electrical supply, especially when other appliances are in use at the same time. This may cause the main fuse to trip.

To prevent this, your SALUS EV Charger is equipped with a Load Curtailment function. A CT clamp, fitted to the incoming mains, continuously monitors the household's electricity usage.

-  In order to use Load Curtailment feature, the charge point must be running firmware version 2.0.40 (0x8C) or later.
-  If the total demand is too high, the charger will automatically lower its charging current.
-  Charging will stop if the available capacity falls below 6 A.
-  When demand falls and capacity is available again, the charger will return to normal charging.

This ensures safe operation, protects your electrical system, and allows efficient charging without the need for expensive upgrades.

* *The Load Curtailment feature is available on single-phase models **EV7EU** and **EV7UK**.*

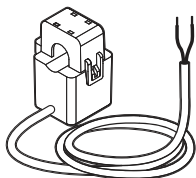

CT Clamp
with 2m signal wire

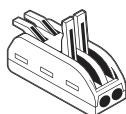



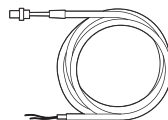





Cable connector



5m extension cable
(terminal connector pre-installed)

Important notes

-  Only qualified personnel may install, maintain or service the charger and CT clamp, in accordance with all applicable regulations and guidance.
-  Switch off power at the circuit breaker before installing the CT clamp.
-  Follow all safety and installation instructions. Incorrect installation or testing may damage the vehicle, the charger or both, and may create a safety hazard.
-  The manufacturer is not liable for damage, loss or injury caused by incorrect installation, misuse, negligence or unauthorised modifications, including tripping of household fuses or damage to other appliances.
-  Load Curtailment reduces overload risk but cannot prevent all faults or trips. Wiring conditions, supply issues or other loads may still cause tripping.
-  Users indemnify the manufacturer, installer and associated parties against claims arising from improper use or installation.
-  Always follow this user guide. Failure to do so may cause malfunction, including tripping of the main fuse/circuit breaker; the manufacturer accepts no responsibility.
-  Inspect regularly and consult a qualified professional if issues arise. Stop using the system immediately if a fault is detected.

This section describes how to install the CT clamp and connect it to the EV charger. The accompanying figure provides a general overview of the installation.

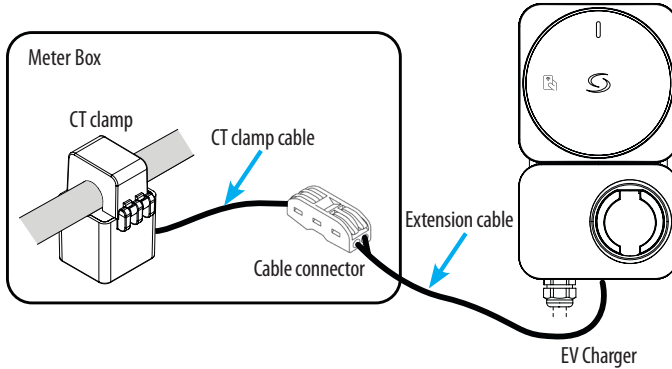

1. Installing the CT Clamp within the Meter Box or Consumer Unit

Position the CT clamp around the incoming live supply cable inside the meter box, ahead of the consumer unit. Ensure that the arrow marking on the clamp is directed towards the property's electrical load.

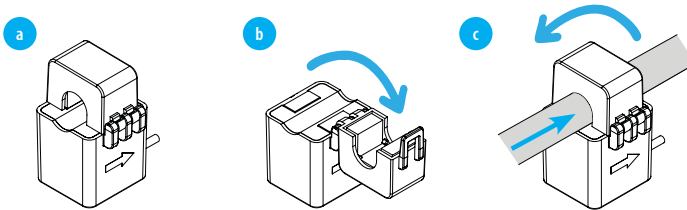

 **Note:** The CT clamp has a maximum primary rated current of 100A.

d Firmly insert the CT clamp wires into one side of the connector accessory. The opposite side is designated for attaching the extension cable wires.

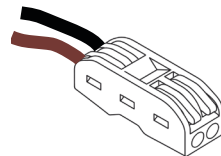

2. CT Clamp connection to EV Charger

a

To carry out the wiring of the CT clamp inside the EV charger, first remove the covers for both upper and lower units. The decorative cover can be released using the recessed area provided, while the inner cover should be removed by unscrewing the screws indicated below.

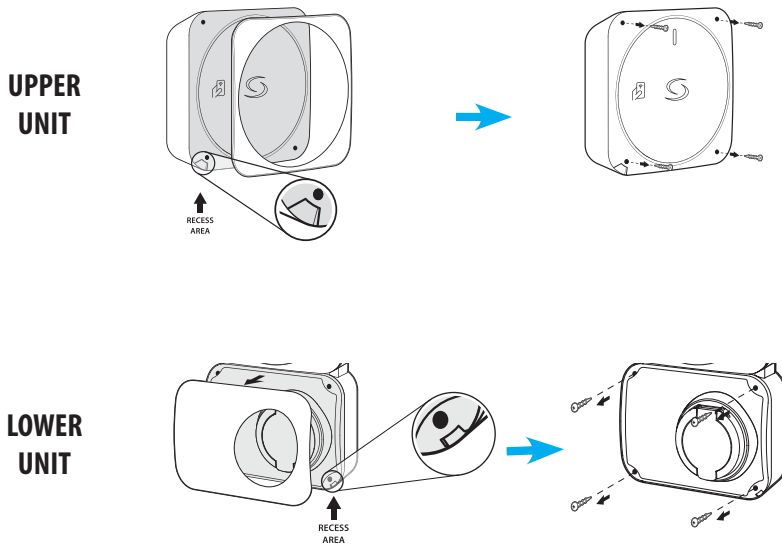

b

Loosen the cable clamp from the bottom side using a screwdriver.

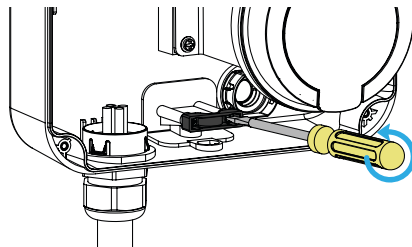

c

Connect the extension cable's connector to the CT clamp input terminal at the top of the EV charger. Then route the remaining length of cable through the cable-exit hole at the bottom of the unit, as shown.

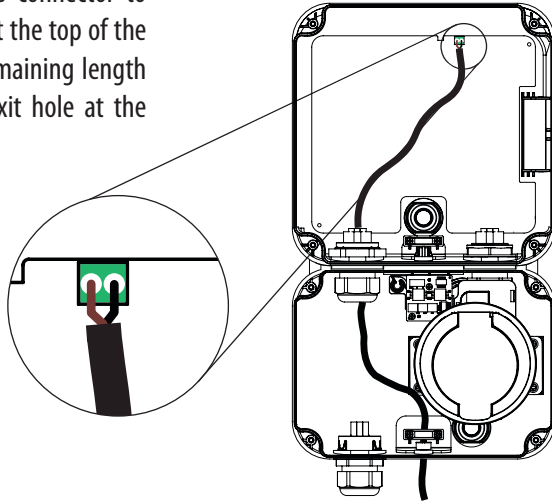

d

Seat the grommet fully to maintain the seal at the bottom of the EV Charger. Avoid twisting the connector and tighten the clamp only enough for strain relief.

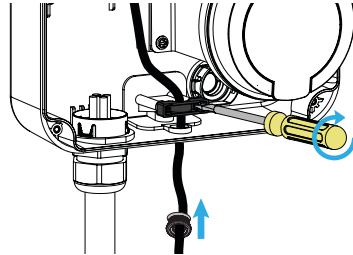

3. Connecting the CT clamp lead to the extension cable

Insert the CT clamp conductors into one side of the connector and the extension cable conductors into the opposite side; press firmly until they lock. Ensure the red conductor of the extension cable is aligned opposite the brown conductor of the CT clamp, as shown. Perform a gentle pull test to confirm the connection is secure.

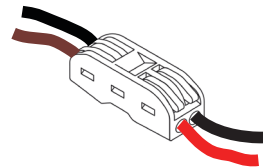

The CT clamp is supplied with a 2 m, 26 AWG cable. The extension cable is a 5 m UL 2516 #20/2C. The total run between the CT clamp and the EV charger may be extended to a maximum of 50 m.

4. Set the household current capacity

Set the rotary switch to the position that matches your property's mains supply rating. The rotary switch is located on the underside of the EV charger, adjacent to the charging socket.

Please note:

This value corresponds to the maximum current that your main circuit breaker or fuse can safely carry and informs the EV charger of the permitted upper limit for the total household current draw.

 For safety reasons, the charger automatically adjusts its charging power to keep the household power usage below 80% of the limit set by this switch.

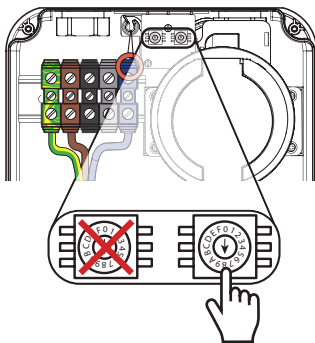

POSITION	CAPACITY
0	Load curtailment feature OFF
1	60A
2	80A
3	100A
4	25A
5	32A
6	40A
7	50A

To disable the Load Curtailment feature, set the rotary switch to "0". When disabled, any CT clamp measurement (if connected) is ignored and does not affect charging operation.

5. Fit back the cover

After connecting the CT clamp to the EV charger, refit the main cover and the decorative cover by reversing the removal steps. Tighten the screws and ensure not to trap any cables.

Technical specifications

CT clamp

Window size	16 mm
Maximum input current	100 A
Output current	33 mA
Turn ratio	1:3000
Frequency	50-60Hz
Operating temperature range	-30 °C to +70 °C
Rated operating voltage	AC 0.66kV
Output cable	2 m, 26 AWG, sheathed

Extension cable with pre-installed terminal connector

Signal cable	5 m, UL2516#20/2C
--------------	-------------------

Troubleshoot

When in standby (not charging), the EV charger checks whether the CT clamp reports a zero current reading, which may indicate incorrect installation or a malfunction.

Indicator: If this condition is detected, the charger's LED flashes green and yellow alternately.



Check the following:

- The CT clamp is fitted to the correct incoming live supply cable.
- The CT clamp is firmly installed and fully closed around the cable.
- The CT clamp is not physically damaged.
- The CT clamp wiring and the extension cable are intact and undamaged.

If charging is started while this condition persists, the maximum charging current will be limited to 6 A

PEN fault protection for EV7UK : 7kW (1-phase) socket type (UK version)

When installed on a PME electrical system it is necessary to protect the user from a potential electric shock that could occur if the combined Neutral and Earth (PEN) conductor on the supply becomes damaged or disconnected.

EV7UK model has an in-built PEN fault protection function, as described in 72.411.4.1 (iv), to disconnect the vehicle from the live, neutral and earth conductors if the voltage is above or below the prescribed levels (greater than 253V and less than 207V). It removes the need for an additional earth electrode or earth rod installation.

Disposal of the SALUS EV Charger

To ensure safe and environmentally responsible disposal, please follow these guidelines when disposing of your SALUS EV Charger.

- **Do not dispose of in household waste** - The SALUS EV Charger contains electronic components that must be recycled properly. Improper disposal may harm the environment and contravene local regulations.
- **Follow local E-Waste regulations** - Check with your local waste-management authority for e-waste collection points, certified recycling facilities and scheduled e-waste disposal programmes.
- **Use an authorised recycling centre** - Many recycling centres recover valuable materials while safely handling hazardous components. Always choose a certified e-waste recycler.
- **Do not attempt to disassemble** - The charger contains high-voltage components and hazardous materials that require professional handling. Disassembling it yourself may be unsafe and will void the warranty.
- **Consider Reuse or Donation** - If the charger is still functional, consider donating it, selling it or repurposing it instead of disposal.

Thank you for disposing of your SALUS EV Charger responsibly and helping to protect the environment.

Troubleshooting and Error Codes

Error name & code	Error description	Troubleshoot
High temperature (0x00000002)	Charging stopped due to high temperature detected.	<ol style="list-style-type: none"> 1. Disconnect the charging cable. 2. Wait until the temperature returns to normal, indicated by the LED turning green. 3. Once the LED is green, reconnect the cable to resume charging.
Charging error (0x00000010)	The EV is requesting a charging current that exceeds the charger's capacity.	<ol style="list-style-type: none"> 1. Disconnect the charging cable. 2. Check any EV settings that may cause this issue or contact your EV manufacturer.
Over voltage (0x00000020)	Charging stopped due to input voltage exceeding limit.	<ol style="list-style-type: none"> 1. Disconnect charging cable. 2. Switch off main power supply and contact technician to verify the electrical installation.
Under voltage (0x00000040)	Charging stopped due to input voltage being below limit.	<ol style="list-style-type: none"> 1. Disconnect charging cable. 2. Switch off main power supply and contact technician to verify the electrical installation.
Charging error (0x00000080)	Charging has stopped due to an error detected in the internal energy meter.	<ol style="list-style-type: none"> 1. Disconnect charging cable. 2. Switch off main power supply and contact customer service for assistance.
Charging error (0x00000100)	Charging stopped due to an error: the internal relay could not be switched ON.	<ol style="list-style-type: none"> 1. Disconnect charging cable. 2. Switch off main power supply and contact customer service for assistance.
Socket lock error (0x00000200)	Charging stopped because the socket failed to lock or unlock.	<ol style="list-style-type: none"> 1. To release a stuck charging cable, push it towards the charger and then press the Unlock button. 2. If problem persist, turn off the main power supply, then turn it back on and attempt to unplug again. 3. If the issue continues, contact customer service for assistance.
Charging error (0x00000400)	Charging stopped because the internal relay could not be turned OFF.	<ol style="list-style-type: none"> 1. Disconnect charging cable. 2. Switch off main power supply and contact customer service for assistance.
Charging error (0x00001000)	Charging stopped due to abnormal CP (Control Pilot) voltage detected from the EV.	<ol style="list-style-type: none"> 1. Disconnect charging cable. 2. Please verify your EV settings or use another charging cable (for socket type charger) to try again or contact your EV manufacturer.
Cable disconnected during use (0x00002000)	Charging has been paused because the connection was unexpectedly interrupted before the session could complete—either by the vehicle (EV suspend) or by the charging station (EVSE suspend).	<ol style="list-style-type: none"> 1. Disconnect charging cable. 2. Reconnect the charging cable and attempt to charge again.

Error name & code	Error description	Troubleshoot
Cable disconnected during use (0x00004000)	Charging stopped due to abnormal disconnection before the charging process was completed.	<ol style="list-style-type: none"> 1. Disconnect charging cable. 2. Reconnect the charging cable to try charging again.
Charging error (0x00008000)	Charging has been halted because the rotary switch for maximum charging current has been set incorrectly.	<ol style="list-style-type: none"> 1. Disconnect charging cable. 2. Switch off main power supply 3. Contact technician to verify the rotary switch setting. 4. If problem persists, contact customer service for assistance.
Cover opened (0x00010000)	The charger's front cover is not properly installed.	<ol style="list-style-type: none"> 1. Install it properly and charger will resume normal operation.
Charging error (0x00020000)	Charging has stopped because residual current was detected.	<ol style="list-style-type: none"> 1. Disconnect charging cable. 2. Switch off main power supply and contact technician to verify the electrical installation.
Cable error (0x00040000)	Charging stopped due to abnormal PP voltage detected from the charging cable.	<ol style="list-style-type: none"> 1. Disconnect charging cable. 2. Please verify your EV settings or use another charging cable (for socket type charger) to try again.
Over frequency (0x00080000)	Charging stopped due to input frequency exceeding the limit.	<ol style="list-style-type: none"> 1. Disconnect charging cable. 2. Switch off main power supply and contact technician to verify the electrical installation.
Under frequency (0x00100000)	Charging stopped due to input frequency being below limit.	<ol style="list-style-type: none"> 1. Disconnect the charging cable. 2. Switch off main power supply and contact technician to verify the electrical installation.
PEN fault (0x00400000)	Charging stopped due to a detected PEN fault.	<ol style="list-style-type: none"> 1. Disconnect charging cable. 2. Switch off main power supply and contact technician to verify the electrical installation.
PEN fault (0x00800000)	Charging stopped due to PEN fault is found. (3 phase)	<ol style="list-style-type: none"> 1. Disconnect charging cable. 2. Switch off main power supply and contact technician to verify the electrical installation.
Charging error (0x01000000)	Charging has stopped because an abnormal diode voltage was detected in the EV.	<ol style="list-style-type: none"> 1. Disconnect charging cable. 2. Please verify your EV settings or use another charging cable (for socket type charger) to try again or contact your EV manufacturer.
Under voltage (0x10000000)	The input voltage briefly fell below the permissible limit but did not interrupt the charging process.	<ol style="list-style-type: none"> 1. Contact a technician to check the electrical installation and improve input voltage stability.

*Hereby, Salus Controls., declares that this EV Charger is in compliance with the essential requirements and other relevant provisions of RE Directive 2014/53/EU.
A copy of the full DoC is attached.*

*SALUS Controls plc
Units 8-10, Northfield Business
Park, Forge Way, Parkgate
Rotherham, S60 1SD, UK*

SALUS Controls plc
Units 8-10,
Northfield Business Park,
Forge Way, Parkgate,
Rotherham, S60 1SD,
United Kingdom

SALUS Controls GmbH,
Dieselstrasse 34,
63165 Mühlheim am Main,
Germany

Email: tech@salus-tech.com



www.saluscontrols.com

SALUS Controls is a member of the Computime Group

Maintaining a policy of continuous product development SALUS Controls plc reserve the right to change specification, design and materials of products listed in this brochure without prior notice.

V11
01/2026

