

Manual

Head Office:
SALUS Controls plc
SALUS House
Dodworth Business Park South,
Whinby Road, Dodworth,
Barnsley S75 3SP, UK.

T: +44 (0) 1226 323961
E: sales@salus-tech.com



www.salus-controls.com

SALUS Controls is a member of the Computime Group.

Maintaining a policy of continuous product development SALUS Controls plc reserve the right to change specification, design and materials of products listed in this brochure without prior notice.

Wiring centre description

1. Cartridge fuse 5 x 20 mm 2 A
2. Power Supply
3. Diodes
4. NSB (Night Set Back reduction) function
5. Thermostats connection
6. Actuators connection
- 7A. PL06 - pump (or boiler) control module
- 7B. PL07 - pump and boiler control module
8. Serial connector for PL06 and PL07 modules

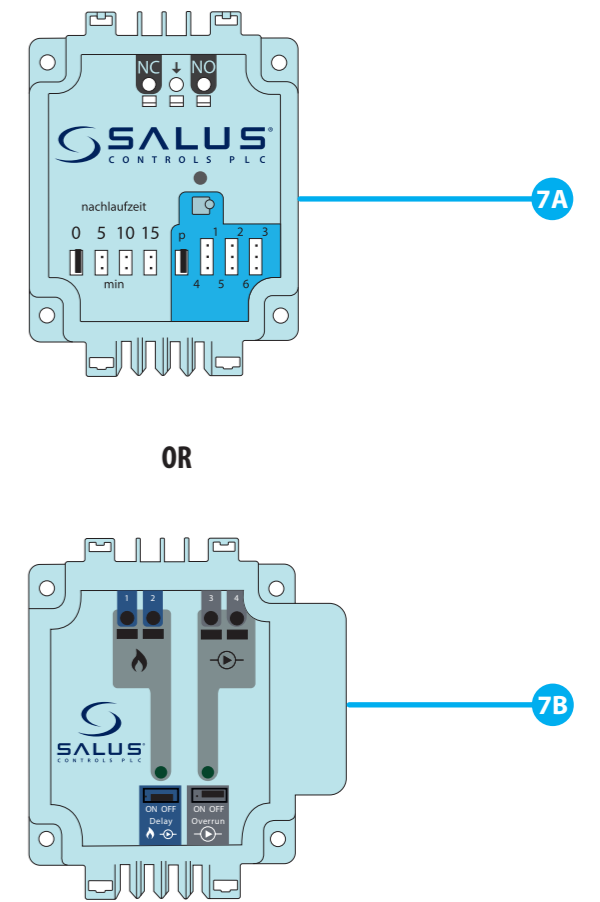
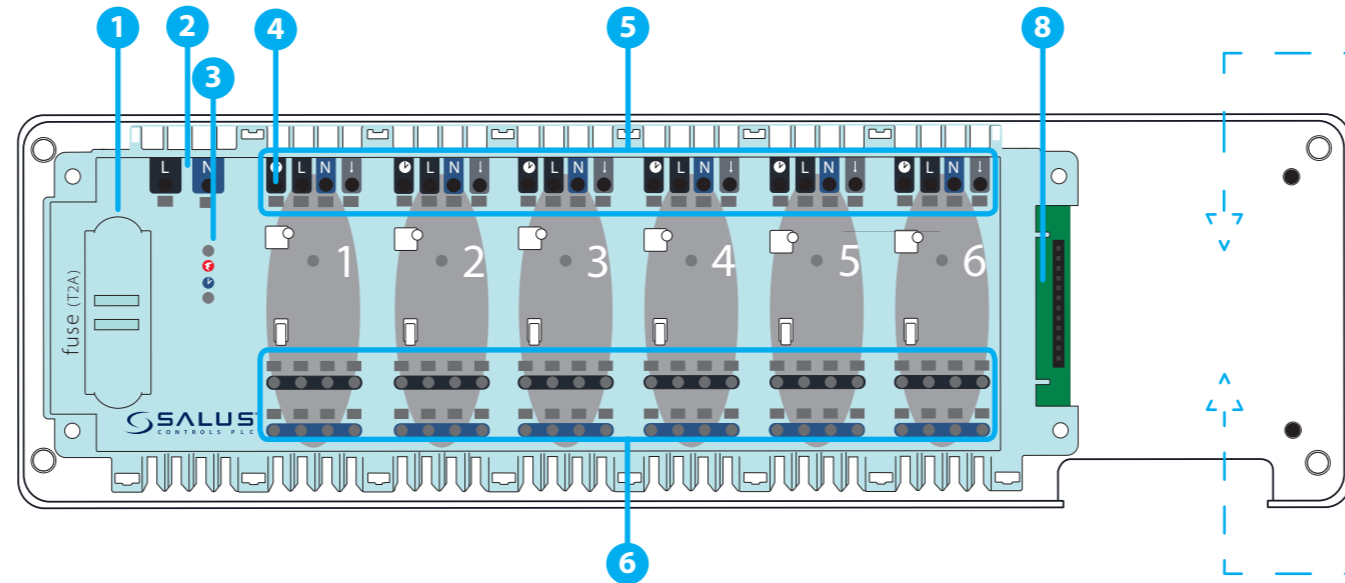

Introduction

Wired KL06 230V wiring centre allows easy and quick connection of thermostats and actuators. It has a serial connector for additional modules (sold separately):

- PL06 Pump or boiler control module
- PL07 Pump and boiler control module

The KL06 230V wiring centre is adapted to work with NC type actuators (normally closed) and maximum 6 thermostats.

Product Compliance

This product complies with the essential requirements and other relevant provisions of the following EU Directives: EMC 2014/30/EU, Low Voltage Directive LVD 2014/35/EU, RoHS directive 2011/65/EU. The full text of the EU Declaration of Conformity is available at the following internet address: www.saluslegal.com.

Safety information

Use in accordance to national and EU regulations. Use the device as intended, keeping it in dry condition. Product for indoor use only. Installation must be carried out by a qualified person in accordance to national and EU regulations.

Before any of operation related to power supply (connecting wires, installing the device, etc.), make sure that KL06 is not connected to any power source. Installation must be carried out by a qualified person. Incorrect connection of the wires may cause damage to the wiring centre. The KL06 can not be used in conditions of water vapor condensation neither exposed to water.

Technical Information

Power Supply	230 V AC 50 Hz
Max load	2 (1) A
Outputs	Terminals for actuators (230 V)
Dimensions [mm]	300 x 86 x 63

1. Fuse

Note: Replace the fuse only when the wiring centre is disconnected from power supply (230 V ~).

Main fuse is located under the housing cover next to power supply terminals and secures the wiring centre and the devices connected to it. Use cartridge fuses (5x20 mm) with nominal max current 2 A. To replace fuse remove the fuse holder with a flat screwdriver and pull out the fuse.

2. Power Supply

Power supply for wiring centre is 230 V ~ 50Hz.

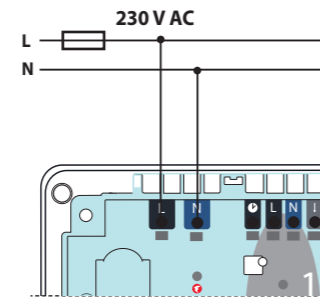

- Features:
- two-wire installation,
 - made in accordance with applicable regulations.

3. LED diodes

- - green LED diode indicates power supply connection (230 V AC)
- - orange LED diode indicates NSB function being activated

4. NSB (Night Set Back reduction) function

NSB function is activated in non-programmable Salus thermostats of the Expert NSB, HTR, BTR series via external signal. NSB 230 V signal (night-time temperature reduction) is sent via an external timer or programmable thermostat connected to the KL06 wiring centre. Non-programmable thermostats are receiving NSB signal and reducing setpoint temperature (by switching to eco mode). All thermostats have to be connected using a 4-wire cable (min. 4 x 0,75 mm², max. 4 x 1,5 mm²).

5. Thermostats connection

- Connecting EXPERT NSB, HTR or BTR series thermostats with NSB function

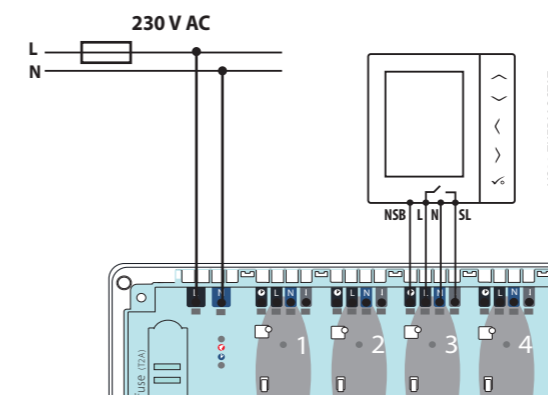

- Connecting a 230 V thermostat to the KL08NSB wiring centre (e.g. RT200)

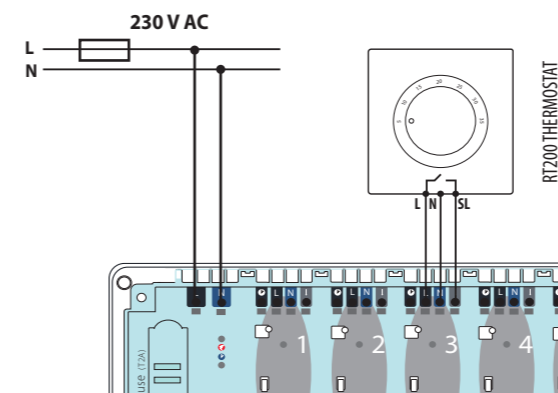

- Connecting ON/OFF battery-powered thermostat with voltage-free COM / NO output contacts (e.g. 091FL, RT310, RT510)

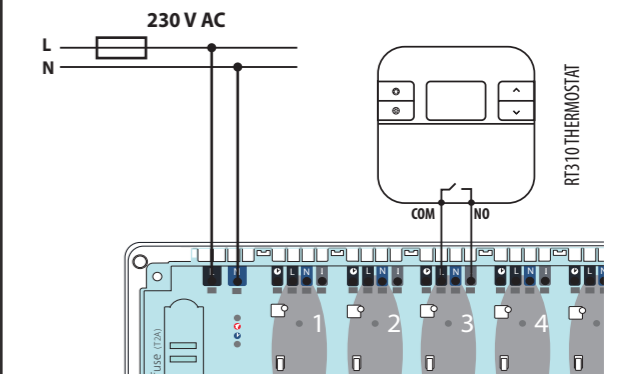

Note: In NSB, HTR, ERT, BTR product series follow interchangeable signifying:
↑ = SL
○ = NSB

6. Actuators connection

The actuator wires should be secured with the self locking connectors in the appropriate zone. Up to 6 actuators with a load of up to 2 Watts each can be connected to a single zone. Should more than 6 actuators be required in a zone use an additional relay to relieve the output.

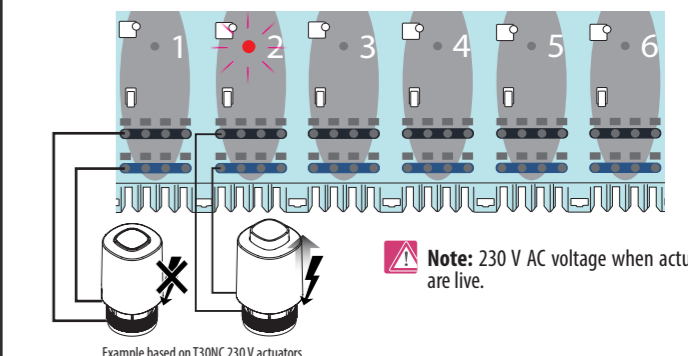

Note: 230 V AC voltage when actuators are live.

Example based on T30NC 230 V actuators

7 A. PL06 – pump (or boiler) control module

PL06 module is used to control the pump (or boiler) using volt-free NC/COM/NO contacts. When any of thermostats connected to the KL06 230 V reports heat demand, COM/NO contacts are closing. COM/NO contacts are opening, when thermostats connected to the wiring centre will stop sending signal for heating.

Jumpers 0-15

These are used to set in minutes the delay time (overrun time). Default setting is „0“.

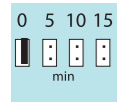

0-15 values specify the time in minutes. E.g. when jumper is set to value „0“, COM/NO output will turn off as soon as the thermostats stop calling for heat. If jumper will be set to the value „10“, the module will turn off 10 min after the thermostats stop calling for heat.

Jumpers P,1,2,3,4,5,6

They are used to select the zone which turns on the module. Default setting is „P“.

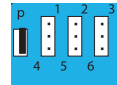

P - all zones start the module

1, 2, 3, 4, 5, 6 – select the specific zone which turns on the module.

PUMP CONTROL

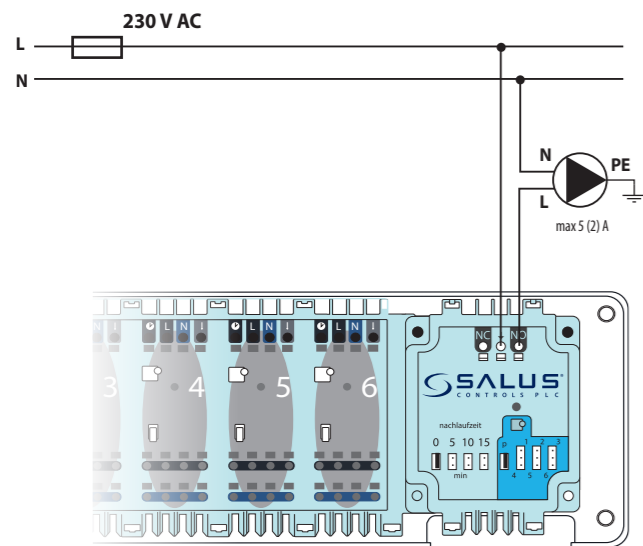

BOILER CONTROL

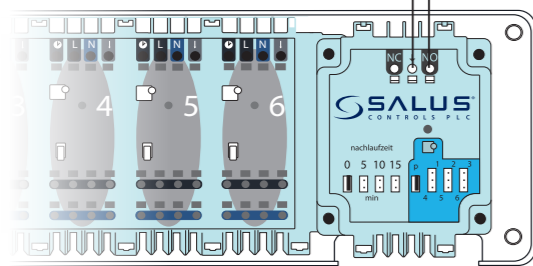
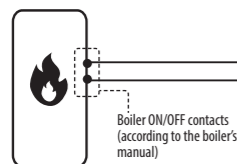

Power Supply	from the KL06 wiring centre
Max load	5 (2) A
Outputs	NO/COM/NC relay
Dimensions [mm]	60 x 80 x 20

7 B. PL07 – pump and boiler control module

PL07 module is used to control the pump and the boiler using volt-free COM/NO contacts. When any of thermostats connected to the KL06 230V reports heat demand, COM/NO contacts are closing. COM/NO contacts are opening, when thermostats connected to the wiring centre will stop sending signal for heating.

ON-OFF Delay jumper

Is used to activate the delay output for the pump and boiler. Default is „ON“.



- „ON“ position activates the pump and boiler outputs with a delay of 3 minutes after the heating signal is supplied from any of the thermostats connected to the wiring centre.
- „OFF“ position causes immediate activation of the pump and boiler outputs.

ON-OFF Overrun jumper

Is used to activate the delay output for the pump when heating is satisfied. Default is „ON“.



- „ON“ position turns OFF the pump output with a delay of 3 minutes when all thermostats stop calling for heat.
- „OFF“ position immediately turns OFF the pump output when all thermostats stop calling for heat.

PUMP AND BOILER CONTROL

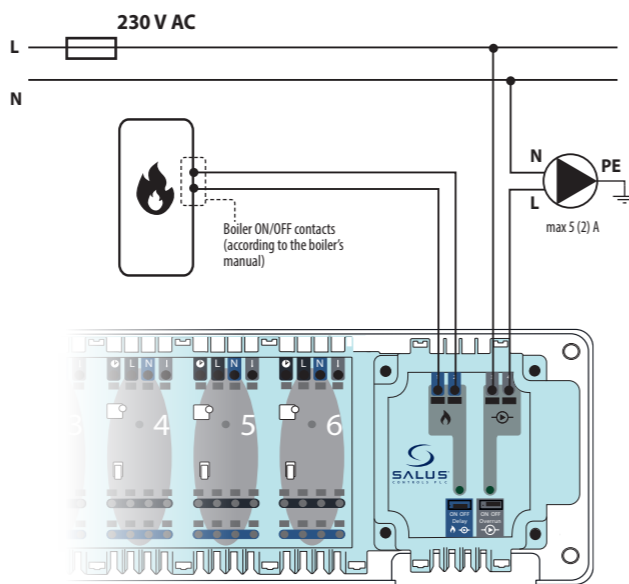

Power Supply	from the KL06 wiring centre
Max load	5 (2) A
Outputs	2 x NO/COM relay
Dimensions [mm]	70 x 80 x 20

8. Serial connector for PL06 and PL07 modules.

It provides communication between the KL06 wiring centre and the PL06/PL07 modules. KL06 wiring centre + PL06/PL07 module increases functionality and additionally makes possible to control pump and/or boiler. PL06/PL07 module is powered from the wiring centre.

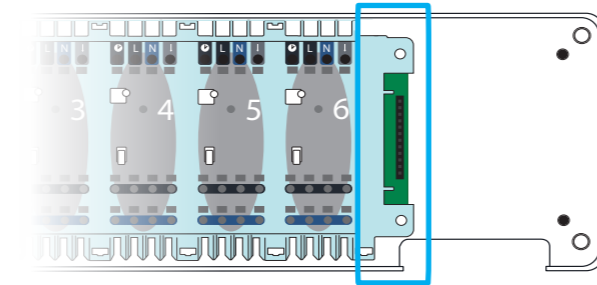

INSTALLATION

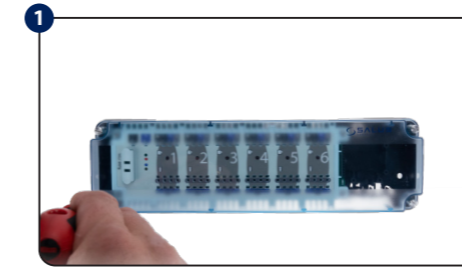

Remove the top cover of the wiring centre.

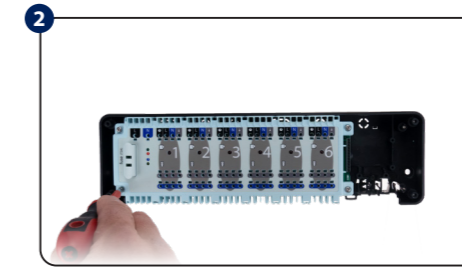

Unscrew the main housing (see picture).

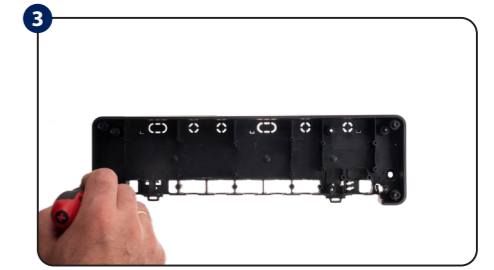

Mount the back side of the housing to the wall. When mounting on a DIN rail, open the hooks on the back of the housing.

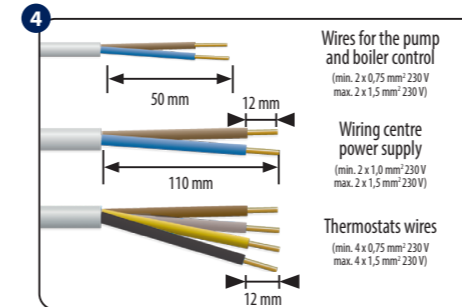

Remove the appropriate pieces of insulation from the wires.

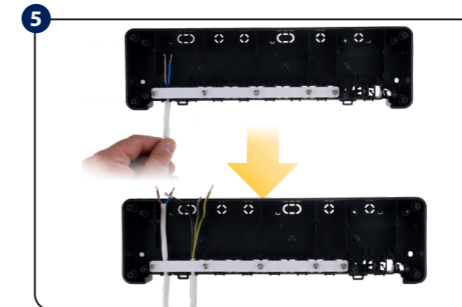

Thread the wires under the mounting belt in the back part of the wiring centre.

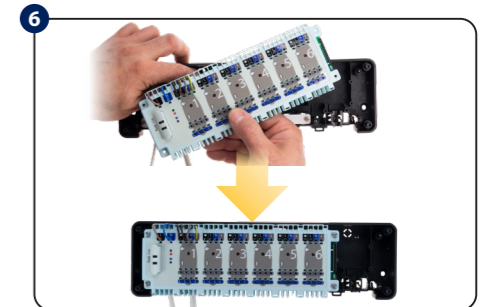

Thread the wires through the slots in the top part of the wiring centre and connect it to the terminals.

Set includes supplementary accessories (to support installation proces).

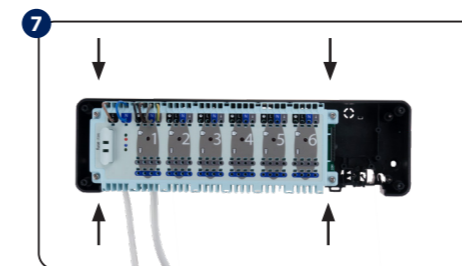

Adjust the wires and screw the main housing of the wiring centre to the rear housing.

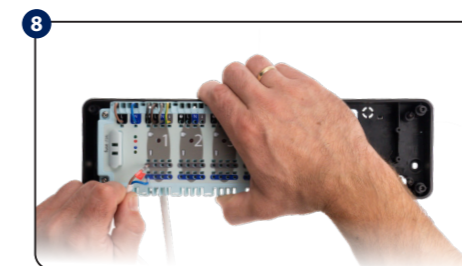

Connect the thermoelectric actuators wires.

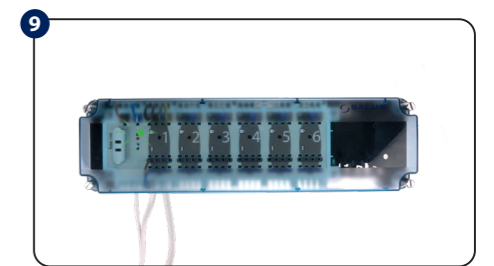

Make sure that all the wires are properly connected, mount top cover and power up the wiring centre - the green „Power“ indicator LED will illuminate.

INSTALLATION OF THE ADDITIONAL MODULE PL06 OR PL07 ON THE EXAMPLE OF PL06 MODULE

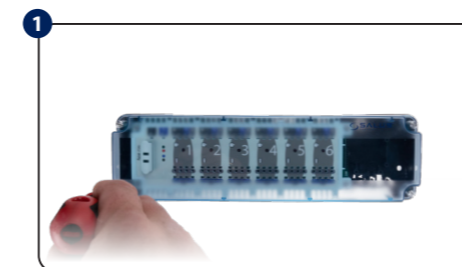

Remove the top cover of the wiring centre.

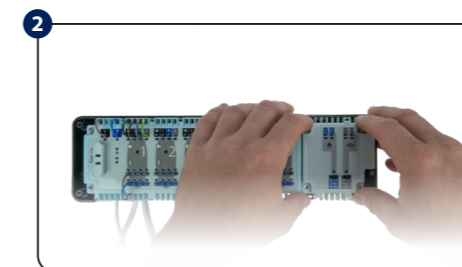

Connect the PL06 or PL07 module to the serial connector.

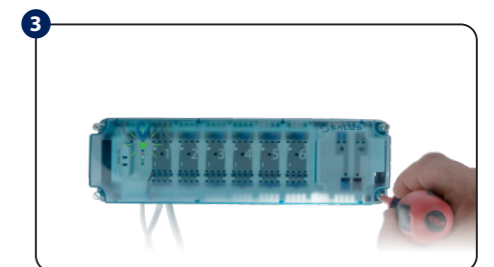

Make sure that all the wires are properly connected, mount top cover and power up the wiring centre - the green „Power“ indicator LED will illuminate.

Note: Before connecting PL06/PL07 module, disconnect the main power from the KL06 wiring centre.