

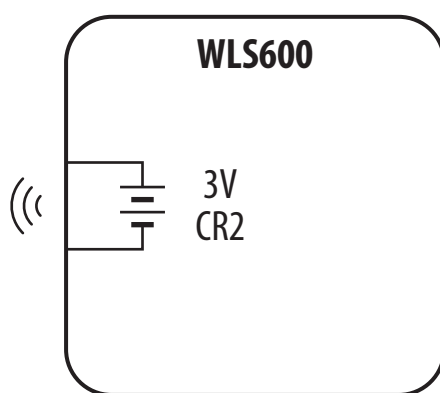















# WLS600 - Diagramă conexiuni electrice.



## LEGENDĂ

	Alimentare cu baterii		Comunicare Wireless
L, N	230V AC		Pompă
	Fuse		Vane motorizate
COM, NO, NC	leșire lipsită de potențial		Senzor de temperatură
S, S1, S2	Borne de intrare		Ventilator cu 3 viteze 230V AC
SL	230V AC voltage leșire		Bec sau altă sarcină
	Contact normal deschis NO		Actuator termoelectric
	Contact normal închis NC		Programator
	Comutator NC/COM/NO		Contact extern, normal deschis
	Cazan- Conexiune la cazan		Convertor de energie