

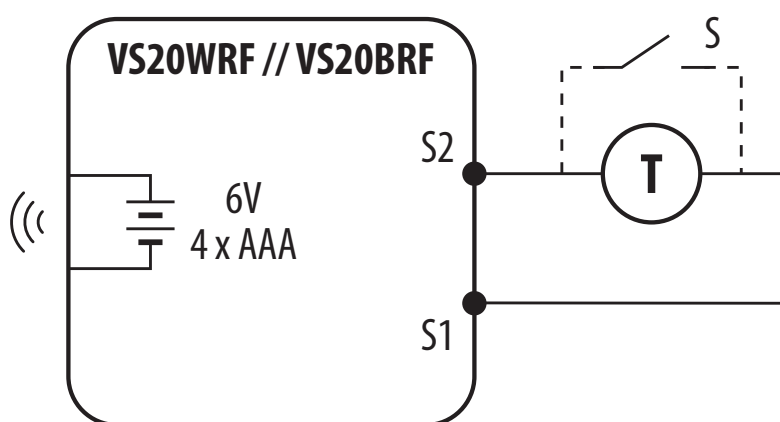













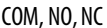





# VS20WRF - Diagramă conexiuni electrice.



## LEGENDĂ

	Alimentare cu baterii		Comunicare Wireless
	230V AC		Pompă
	Fuse		Vane motorizate
	Ieșire lipsită de potențial		Senzor de temperatură
	Borne de intrare		Ventilator cu 3 viteze 230V AC
	230V AC voltage ieșire		Bec sau altă sarcină
	Contact normal deschiș NO		Actuator termoelectric
	Contact normal închis NC		Programator
	Comutator NC/COM/NO		Contact extern, normal deschiș
	Cazan- Conexiune la cazan		Convertor de energie